

# ACPL-M50L, ACPL-054L, ACPL-W50L, ACPL-K54L



Low Power, 1 MBd Digital Optocoupler

## Data Sheet

### Description

The Broadcom® ACPL-M50L (single-channel in SO-5 footprint), ACPL-054L (dual-channel in SO-8 footprint), ACPL-W50L (single-channel in stretched SO-6 footprint), and ACPL-K54L (dual-channel in stretched SO-8 footprint) are low power, low-input current, 1 MBd digital optocouplers.

These digital optocouplers use an insulating layer between the light-emitting diode and an integrated photon detector to provide electrical insulation between input and output. Separate connections for the photodiode bias and output transistor collector increase the speed up to a hundred times over that of a conventional photo-transistor coupler by reducing the base-collector capacitance.

The ACPL-M50L/054L/W50L/K54L has an increased common mode transient immunity of 15 kV/ $\mu$ s minimum at  $V_{CM} = 1500V$  over a temperature range of  $-40^{\circ}C$  to  $105^{\circ}C$ . The current transfer ratio (CTR) is 140% typical for ACPL-M50L or 130% typical for ACPL-054L/W50L/K54L at  $I_F = 3mA$ . This digital optocoupler can be used in any TTL/CMOS, TTL/LSTTL, or wide bandwidth analog applications.

**CAUTION** Take normal static precautions in handling and assembly of this component to prevent damage and/or degradation that might be induced by electrostatic discharge (ESD). The components featured in this data sheet are not to be used in military or aerospace applications or environments

### Features

- Wide supply voltage  $V_{CC}$ : 2.7V to 24V
- Low drive current: 3 mA
- Open-collector output
- TTL compatible
- Compact SO-5, SO-8, stretched SO-6, and stretched SO-8 package
- 15 kV/ $\mu$ s high common-mode rejection at  $V_{CM} = 1500V$
- Guaranteed performance from temperature range:  $-40^{\circ}C$  to  $+105^{\circ}C$
- Low propagation delay: 1  $\mu$ s max at 5V
- Worldwide safety approval:
  - UL1577 recognized, 3750  $V_{rms}/1$  min for ACPL-M50L/054L, 5000  $V_{rms}/1$  min for ACPL-W50L/K54
  - CSA Approval
  - IEC/EN/DIN EN 60747-5-5 Approval for Reinforced Insulation

### Applications

- Communications interface
- Digital signal isolation
- Micro-controller interface
- Feedback elements in switching power supplies
- Digital isolation for A/D, D/A conversion digital field

**Figure 1 Functional Diagram**

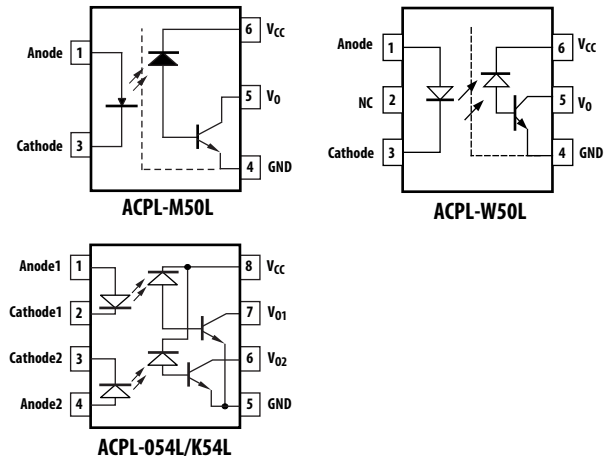

**Table 1 Truth Table**

LED	VO
ON	LOW
OFF	HIGH

**NOTE** The connection of a 0.1-μF bypass capacitor between pins 4 and 6 for ACPL-M50L/W50L and between pins 5 and 8 for ACPL-054L/K54L is recommended.

## Ordering Information

ACPL-M50L and ACPL-054L are UL Recognized with 3750 V<sub>rms</sub> for 1 minute per UL1577. ACPL-W50L and ACPL-K54L are UL Recognized with 5000 V<sub>rms</sub> for 1 minute per UL1577.

**Table 2 Ordering Information**

Part Number	Option	Package	Surface Mount	Tape and Reel	IEC/EN 60747-5-5	Quantity
	RoHS Compliant					
ACPL-M50L	-000E	SO-5	X			100 per tube
	-060E		X		X	100 per tube
	-500E		X	X		1500 per reel
	-560E		X	X	X	1500 per reel
ACPL-054L	-000E	SO-8	X			100 per tube
	-060E		X		X	100 per tube
	-500E		X	X		1500 per reel
	-560E		X	X	X	1500 per reel
ACPL-W50L	-000E	Stretched SO-6	X			100 per tube
	-060E		X		X	100 per tube
	-500E		X	X		1000 per reel
	-560E		X	X	X	1000 per reel
ACPL-K54L	-000E	Stretched SO-8	X			80 per tube
	-060E		X		X	80 per tube
	-500E		X	X		1000 per reel
	-560E		X	X	X	1000 per reel

To order, choose a part number from the part number column and combine with the desired option from the option column to form an order entry.

### Example 1:

ACPL-M50L-500E to order product of Mini-flat Surface Mount 5-pin package in Tape and Reel packaging with RoHS compliant. Option data sheets are available. Contact your Broadcom sales representative or authorized distributor for information.

## Package Outline Drawings

Figure 2 ACPL-M50L SO-5 Package (JEDEC M0-155)

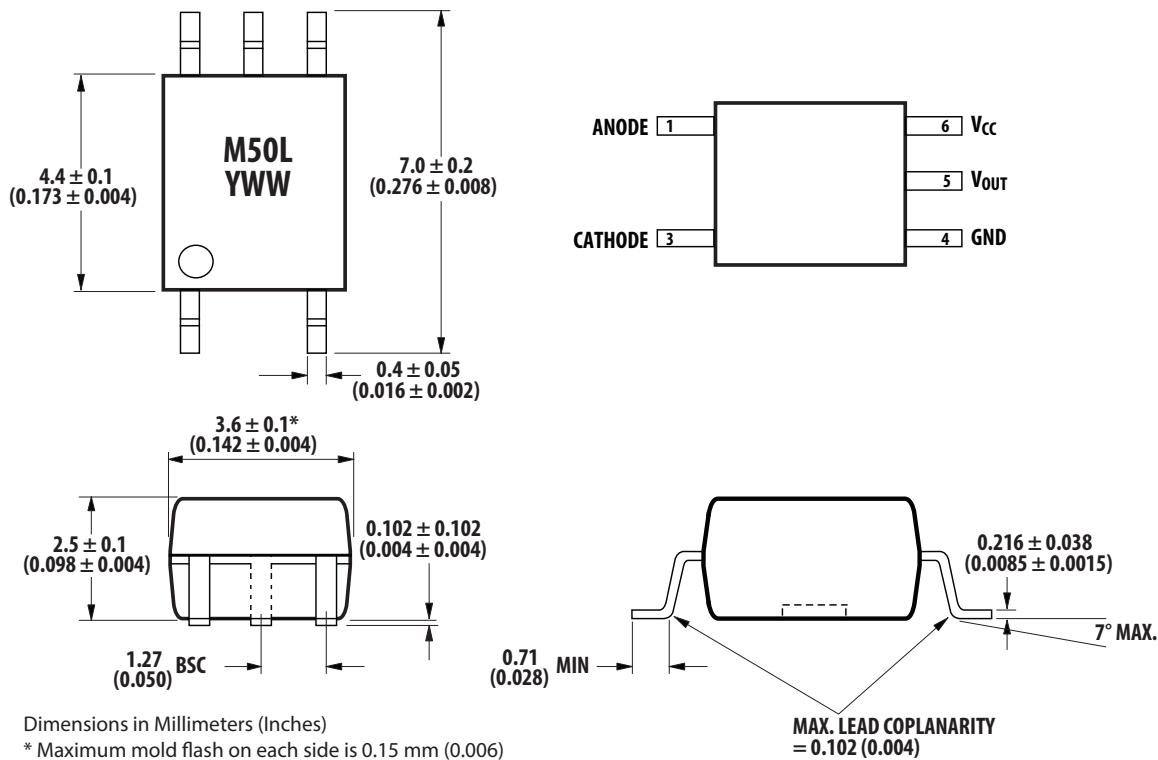
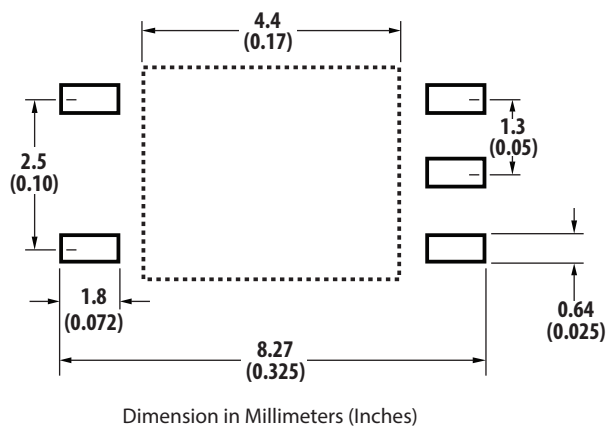
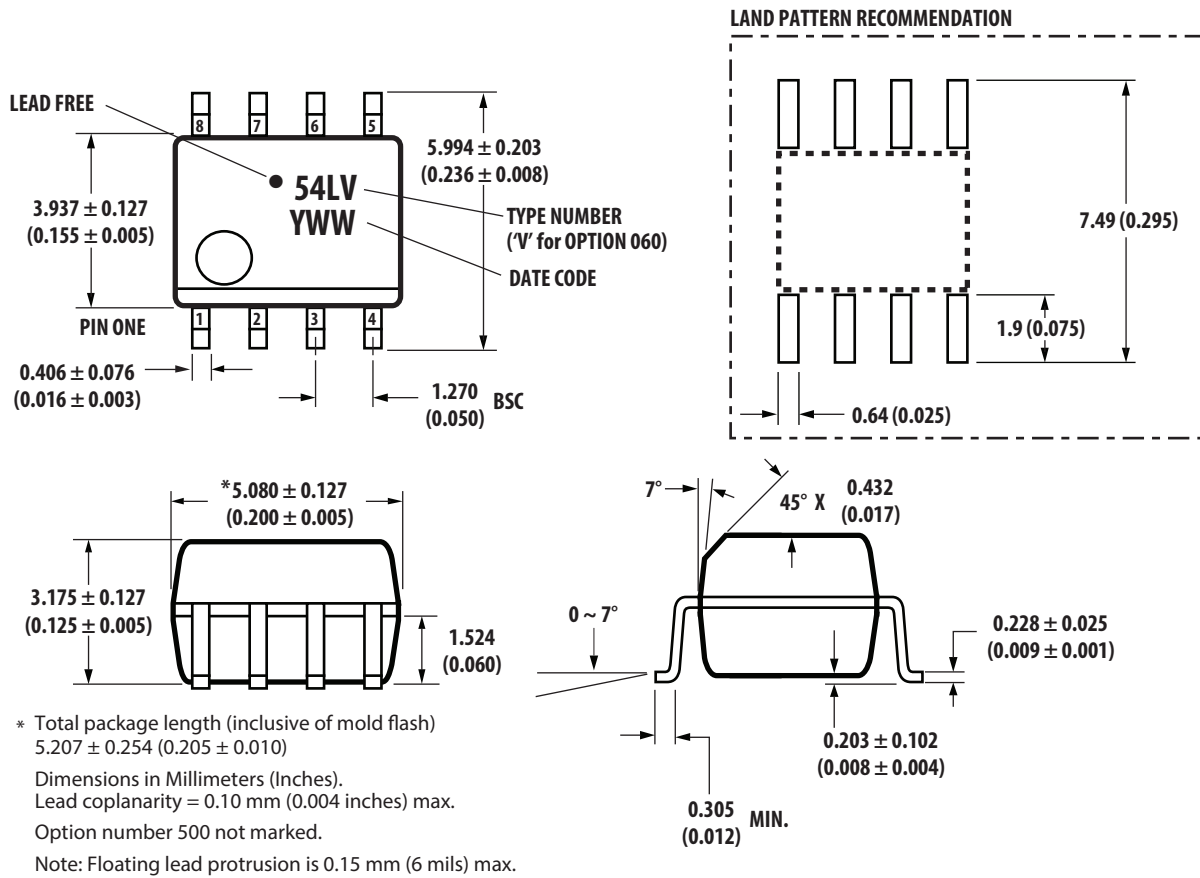

Figure 3 Land Pattern Recommendations



**Figure 4 ACPL-054L (Small Outline SO-8 Package)**



**Figure 5 ACPL-W50L Stretched SO-6 Package**

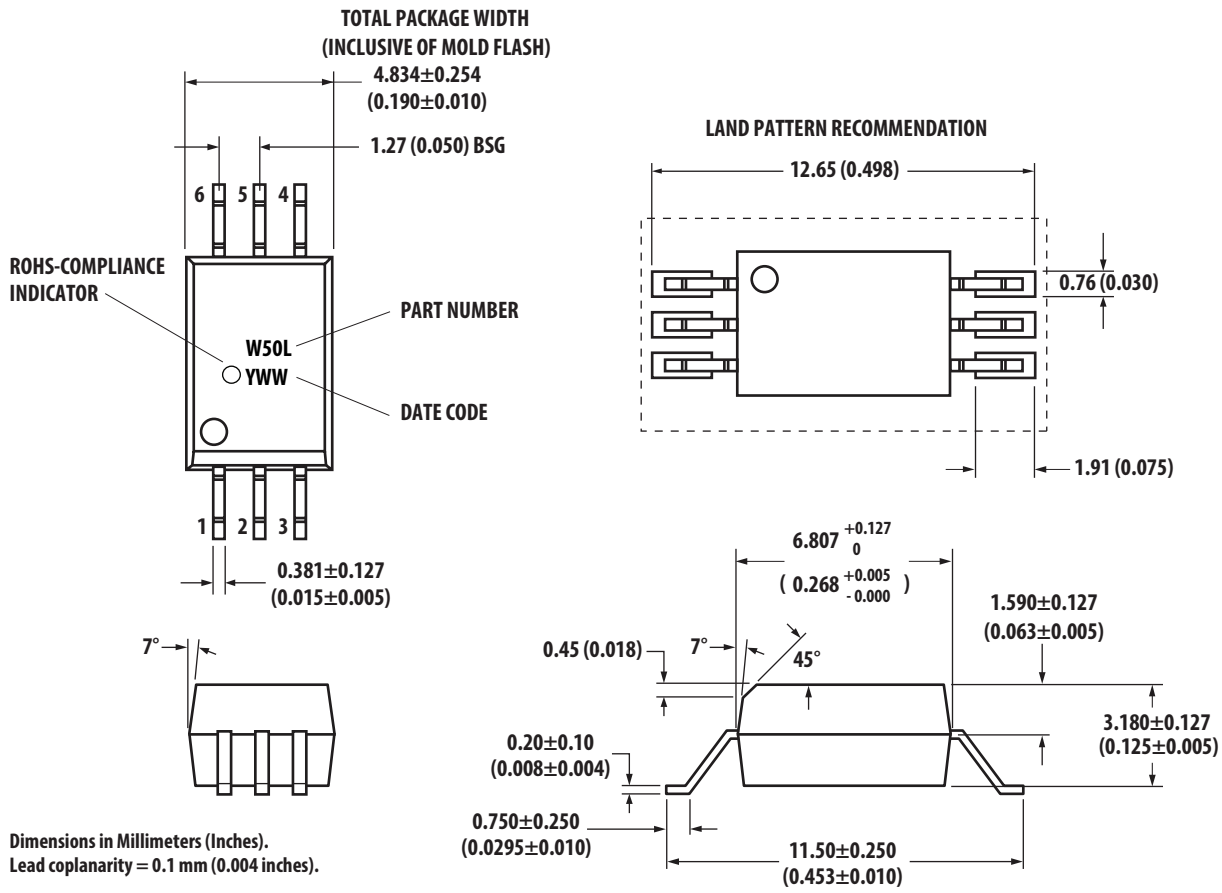

**Figure 6 ACPL-K54L Stretched SO-8 Package**

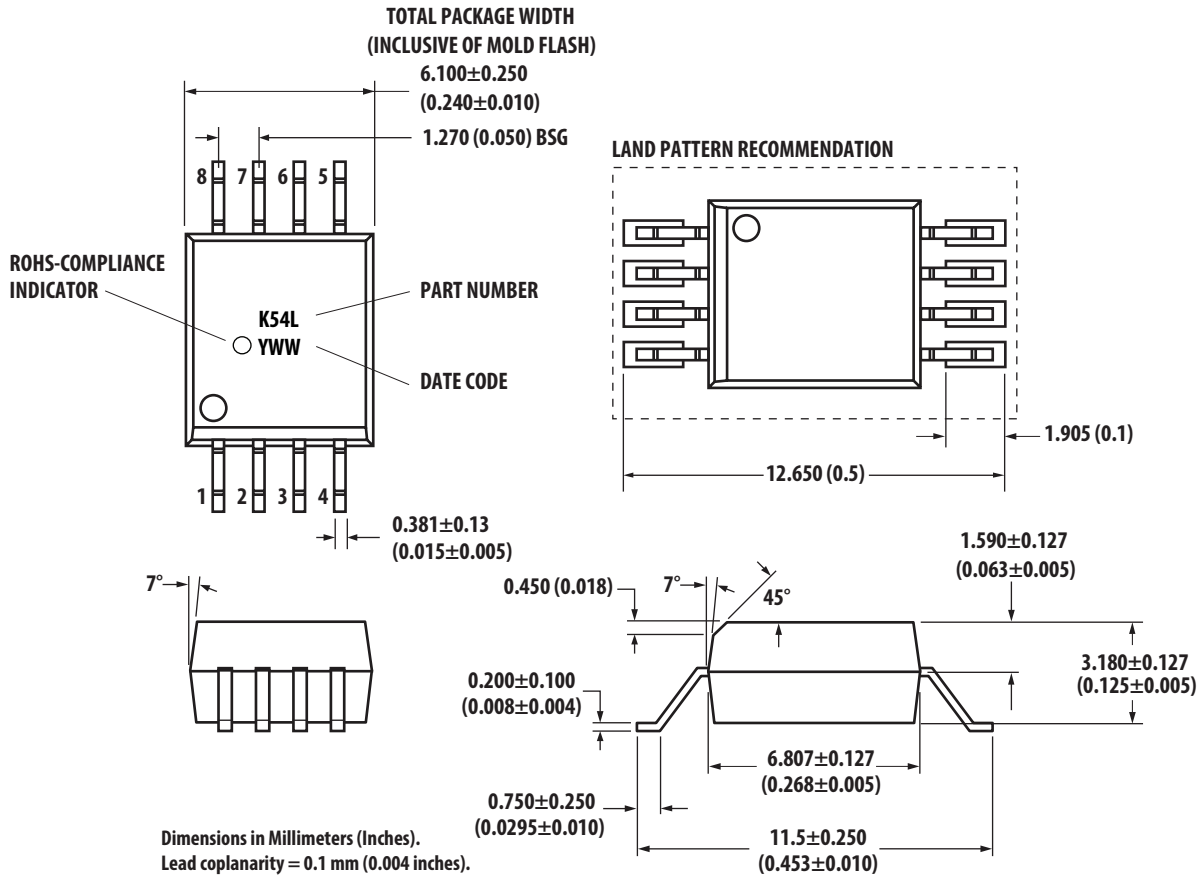

### Solder Reflow Profile

Recommended reflow condition as per JEDEC Standard, J-STD-020 (latest revision). Non-halide flux should be used.

### Regulatory Information

The ACPL-M21L/024L/021L/W21L/K24L is approved by the following organizations.

<b>UL</b>	Approval under UL 1577, component recognition program up to $V_{ISO} = 3750 V_{RMS}$ for ACPL-M50L/054L/021L and $V_{ISO} = 5000 V_{RMS}$ for ACPL-W50L/K54L.
<b>CSA</b>	Approval under CSA Component Acceptance Notice #5.
<b>IEC/EN 60747-5-5</b>	(Option 060E only).

**Table 3 Insulation and Safety Related Specifications**

Parameter	Symbol	ACPL-M50L	ACPL-054L	ACPL-W50L ACPL-K24L	Units	Conditions
Minimum External Air Gap (Clearance)	L(101)	5	4.9	8	mm	Measured from input terminals to output terminals, shortest distance through air.
Minimum External Tracking (Creepage)	L(102)	5	4.8	8	mm	Measured from input terminals to output terminals, shortest distance path along body.
Minimum Internal Plastic Gap (Internal Clearance)		0.08	0.08	0.08	mm	Through insulation distance conductor to conductor, usually the straight line distance thickness between the emitter and detector.
Tracking Resistance (Comparative Tracking Index)	CTI	175	175	175	V	DIN IEC 112/VDE 0303 Part 1
Isolation Group		IIIa	IIIa	IIIa	—	Material Group (DIN VDE 0110, 1/89, Table 1)

**Table 4 IEC/EN60747-5-5 Insulation Characteristics<sup>a</sup> (Option 060E)**

Description	Symbol	Characteristic		Unit
		ACPL-M21L/ 024L/021L	ACPL-W21L/ K24L	
Installation classification per DIN VDE 0110/39, Table 1 for rated mains voltage $\leq 150 V_{rms}$ for rated mains voltage $\leq 300 V_{rms}$ for rated mains voltage $\leq 600 V_{rms}$ for rated mains voltage $\leq 1000 V_{rms}$		I – IV I – III I – II	I – IV I – IV I – III I – III	—
Climatic Classification		55/105/21	55/105/21	—
Pollution Degree (DIN VDE 0110/39)		2	2	—
Maximum Working Insulation Voltage	$V_{IORM}$	560	1140	$V_{peak}$
Input to Output Test Voltage, Method b <sup>a</sup> $V_{IORM} \times 1.875 = V_{PR}$ , 100% Production Test with $t_m = 1$ sec, Partial discharge $< 5$ pC	$V_{PR}$	1050	2137	$V_{peak}$
Input to Output Test Voltage, Method a <sup>a</sup> $V_{IORM} \times 1.6 = V_{PR}$ , Type and Sample Test, $t_m = 10$ sec, Partial discharge $< 5$ pC	$V_{PR}$	896	1824	$V_{peak}$
Highest Allowable Overvoltage (Transient Overvoltage $t_{ini} = 60$ sec)	$V_{IOTM}$	6000	8000	$V_{peak}$
Safety-limiting values – maximum values allowed in the event of a failure. Case Temperature Input Current <sup>b</sup> Output Power <sup>b</sup>	$T_S$ $I_{S, INPUT}$ $P_{S, OUTPUT}$	150 150 600	175 230 600	$^{\circ}C$ mA mW
Insulation Resistance at $T_S$ , $V_{IO} = 500$ V	$R_S$	$>10^9$	$>10^9$	$\Omega$

a. Refer to the optocoupler section of the *Isolation and Control Components Designer's Catalog*, under Product Safety Regulations section, (IEC/EN 60747-5-5) for a detailed description of Method a and Method b partial discharge test profiles.

b. Refer to the following figure for dependence of  $P_S$  and  $I_S$  on ambient temperature.

**NOTE** These optocouplers are suitable for "safe electrical isolation" only within the safety limit data. Maintenance of the safety limit data shall be ensured by means of protective circuits.



**Table 5 Absolute Maximum Ratings**

Parameter	Symbol	Min.	Max.	Units
Storage Temperature	$T_S$	-55	125	°C
Operating Temperature	$T_A$	-40	105	°C
Lead Soldering Cycle	Temperature	—	260	°C
	Time	—	10	s
Average Forward Input Current <sup>a</sup>	$I_{F(avg)}$	—	20	mA
Peak Forward Input Current <sup>b</sup> (50% duty cycle, 1 ms pulse width)	$I_{F(peak)}$	—	40	mA
Peak Transient Input Current ( $\leq 1 \mu s$ pulse width, 300 ps)	$I_{F(trans)}$	—	1	A
Reversed Input Voltage	$V_R$	—	5	V
Input Power Dissipation <sup>c</sup>	$P_{IN}$	—	36	mW
Output Power Dissipation <sup>d</sup>	$P_O$	—	45	nW
Average Output Current	IO(AVG)	—	8	mA
Peak Output Current	IO(PEAK)	—	16	mA
Supply Voltage	$V_{CC}$	-0.5	30	V
Output Voltage	$V_O$	-0.5	24	V
Solder Reflow Temperature Profile	See <a href="#">Package Outline Drawings</a>			

- Derate linearly above 85°C free-air temperature at a rate of 0.5 mA/°C.
- Derate linearly above 85°C free-air temperature at a rate of 1.0 mA/°C.
- Derate linearly above 85°C free-air temperature at a rate of 0.9 mW/°C.
- Derate linearly above 85°C free-air temperature at a rate of 1.2 mW/°C.

**Table 6 Recommended Operating Conditions**

Parameter	Symbol	Min.	Max.	Units
Supply Voltage	$V_{CC}$	2.7	24	V
Input Current, High Level	$I_{FH}$	3	10	mA
Operating Temperature	$T_A$	-40	105	°C
Forward Input Voltage (OFF)	$V_{F(OFF)}$	—	0.8	V

## Electrical Specifications (DC)

Over recommended temperature ( $T_A = -40^\circ\text{C}$  to  $+105^\circ\text{C}$ ) and supply voltage ( $2.7\text{V} \leq V_{CC} \leq 24\text{V}$ ). All typical specifications are at  $T_A = 25^\circ\text{C}$ .

**Table 7 Electrical Specifications (DC)**

Parameter	Sym.	Part Number	Min.	Typ.	Max.	Units	Conditions			Fig.
Current Transfer Ratio	CTR <sup>a</sup>	ACPL-M50L	100	140	200	%	$T_A = 25^\circ\text{C}$	$V_O = 0.4\text{V}$	$V_{CC} = 3.3\text{V}$ or $5\text{V}$ , $I_F = 3\text{ mA}$	8, 9
			80	—	—	%		$V_O = 0.5\text{V}$		
		ACPL-054L ACPL-W50L ACPL-K54	93	130	200	%	$T_A = 25^\circ\text{C}$	$V_O = 0.4\text{V}$	$V_{CC} = 3.3\text{V}$ or $5\text{V}$ , $I_F = 3\text{ mA}$	8, 9
			53	—	—	%		$V_O = 0.5\text{V}$		
Logic Low Output Voltage	$V_{OL}$		—	0.2	0.4	V	$T_A = 25^\circ\text{C}$	$I_O = 3\text{ mA}$	$V_{CC} = 3.3\text{V}$ or $5\text{V}$ , $I_F = 3\text{ mA}$	
			—	0.2	0.5	V		$I_O = 1.6\text{ mA}$		
Logic High Output Current	$I_{OH}$		—	0.003	0.5	$\mu\text{A}$	$T_A = 25^\circ\text{C}$	$V_O = V_{CC} = 5.5\text{V}$	$I_F = 0\text{ mA}$	10, 11
			—	0.01	1			$V_O = V_{CC} = 24\text{V}$		
			—	—	80			$V_O = V_{CC} = 24\text{V}$		
Logic Low Supply Current per Channel	$I_{CCL}$		—	36	100	$\mu\text{A}$		$I_F = 3\text{ mA}$ , $V_O = \text{open}$ , $V_{CC} = 24\text{V}$		
Logic High Supply Current per Channel	$I_{CCH}$		—	0.02	2	$\mu\text{A}$		$I_F = 0\text{ mA}$ , $V_O = \text{open}$ , $V_{CC} = 24\text{V}$		
Input Forward Voltage	$V_F$		—	1.5	1.8	V	$T_A = 25^\circ\text{C}$	$I_F = 3\text{ mA}$		7
			—	1.5	1.95	V		$I_F = 3\text{ mA}$		
Input Reversed Breakdown Voltage	$BV_R$		5	—	—	V		$I_R = 10\text{ }\mu\text{A}$		
Temperature Coefficient of Forward Voltage	$\Delta V_F / \Delta T_A$		—	-1.6	—	$\text{mV}/^\circ\text{C}$		$I_F = 3\text{ mA}$		
Input Capacitance	$C_{IN}$		—	77	—	$\text{pF}$		$F = 1\text{ MHz}$ , $V_F = 0$		

a. CURRENT TRANSFER RATIO in percent is defined as the ratio of output collector current,  $I_O$ , to the forward LED input current,  $I_F$ , times 100%.

## Switching Specifications (ACPL-M50L)

Over recommended operating ( $T_A = -40^\circ\text{C}$  to  $105^\circ\text{C}$ ),  $I_F = 3\text{ mA}$ , ( $2.7\text{V} \leq V_{CC} \leq 24\text{V}$ ), unless otherwise specified.

**Table 8 Switching Specifications (ACPL-M50L)**

Parameter	Symbol	Min	Typ	Max	Units	Test Conditions	Fig.
Propagation Delay Time to Logic Low at Output	$T_{PHL}$	—	0.2	0.5	$\mu\text{s}$	$T_A = 25^\circ\text{C}$ Pulse: $f = 10\text{ kHz}$ , Duty cycle = 50%, $I_F = 3\text{ mA}$ , $V_{CC} = 3.3\text{V}$ , $R_L = 1.2\text{ k}\Omega$ , $C_L = 15\text{ pF}$ , $V_{THHL} = 1.5\text{V}$	26
		—	0.2	1	$\mu\text{s}$		12, 26
		—	0.22	0.5	$\mu\text{s}$	$T_A = 25^\circ\text{C}$ Pulse: $f = 10\text{ kHz}$ , Duty cycle = 50%, $I_F = 3\text{ mA}$ , $V_{CC} = 5.0\text{V}$ , $R_L = 1.9\text{ k}\Omega$ , $C_L = 15\text{ pF}$ , $V_{THHL} = 1.5\text{V}$	26
		—	0.22	1	$\mu\text{s}$		14, 26
		—	0.33	0.7	$\mu\text{s}$	$T_A = 25^\circ\text{C}$ Pulse: $f = 10\text{ kHz}$ , Duty cycle = 50%, $I_F = 3\text{ mA}$ , $V_{CC} = 24\text{V}$ , $R_L = 10\text{ k}\Omega$ , $C_L = 15\text{ pF}$ , $V_{THHL} = 1.5\text{V}$	26
		—	0.33	1.3	$\mu\text{s}$		16, 26
Propagation Delay Time to Logic High at Output	$T_{PLH}$	—	0.38	0.8	$\mu\text{s}$	$T_A = 25^\circ\text{C}$ Pulse: $f = 10\text{ kHz}$ , Duty cycle = 50%, $I_F = 3\text{ mA}$ , $V_{CC} = 3.3\text{V}$ , $R_L = 1.2\text{ k}\Omega$ , $C_L = 15\text{ pF}$ , $V_{THHL} = 2.0\text{V}$	26
		—	0.38	1.2	$\mu\text{s}$		12, 26
		—	0.31	0.7	$\mu\text{s}$	$T_A = 25^\circ\text{C}$ Pulse: $f = 10\text{ kHz}$ , Duty cycle = 50%, $I_F = 3\text{ mA}$ , $V_{CC} = 5.0\text{V}$ , $R_L = 1.9\text{ k}\Omega$ , $C_L = 15\text{ pF}$ , $V_{THHL} = 2.0\text{V}$	26
		—	0.31	1	$\mu\text{s}$		14, 26
		—	0.3	0.7	$\mu\text{s}$	$T_A = 25^\circ\text{C}$ Pulse: $f = 10\text{ kHz}$ , Duty cycle = 50%, $I_F = 3\text{ mA}$ , $V_{CC} = 24\text{V}$ , $R_L = 10\text{ k}\Omega$ , $C_L = 15\text{ pF}$ , $V_{THHL} = 2.0\text{V}$	26
		—	0.3	1	$\mu\text{s}$		16, 26
Pulse Width Distortion <sup>a</sup>	PWD	—	0.18	0.8	$\mu\text{s}$	$T_A = 25^\circ\text{C}$ Pulse: $f = 10\text{ kHz}$ , Duty cycle = 50%, $I_F = 3\text{ mA}$ , $V_{CC} = 3.3\text{V}$ , $R_L = 1.2\text{ k}\Omega$ , $C_L = 15\text{ pF}$ , $V_{THHL} = 1.5\text{V}$ , $V_{THLH} = 2.0\text{V}$	26
		—	0.18	1.2	$\mu\text{s}$		26
		—	0.1	0.7	$\mu\text{s}$	$T_A = 25^\circ\text{C}$ Pulse: $f = 10\text{ kHz}$ , Duty cycle = 50%, $I_F = 3\text{ mA}$ , $V_{CC} = 5.0\text{V}$ , $R_L = 1.9\text{ k}\Omega$ , $C_L = 15\text{ pF}$ , $V_{THHL} = 1.5\text{V}$ , $V_{THLH} = 2.0\text{V}$	26
		—	0.1	1	$\mu\text{s}$		26
		—	0.1	0.7	$\mu\text{s}$	$T_A = 25^\circ\text{C}$ Pulse: $f = 10\text{ kHz}$ , Duty cycle = 50%, $I_F = 3\text{ mA}$ , $V_{CC} = 24\text{V}$ , $R_L = 10\text{ k}\Omega$ , $C_L = 15\text{ pF}$ , $V_{THHL} = 1.5\text{V}$ , $V_{THLH} = 2.0\text{V}$	26
		—	0.1	1	$\mu\text{s}$		26
Propagation Delay Difference Between Any Two Parts <sup>b</sup>	$t_{psk}$	—	0.18	0.7	$\mu\text{s}$	$T_A = 25^\circ\text{C}$ Pulse: $f = 10\text{ kHz}$ , Duty cycle = 50%, $I_F = 3\text{ mA}$ , $V_{CC} = 3.3\text{V}$ , $R_L = 1.2\text{ k}\Omega$ , $C_L = 15\text{ pF}$ , $V_{THHL} = 1.5\text{V}$ , $V_{THLH} = 2.0\text{V}$	
		—	0.1	0.6	$\mu\text{s}$	$T_A = 25^\circ\text{C}$ Pulse: $f = 10\text{ kHz}$ , Duty cycle = 50%, $I_F = 3\text{ mA}$ , $V_{CC} = 5.0\text{V}$ , $R_L = 1.9\text{ k}\Omega$ , $C_L = 15\text{ pF}$ , $V_{THHL} = 1.5\text{V}$ , $V_{THLH} = 2.0\text{V}$	
		—	0.1	0.6	$\mu\text{s}$	$T_A = 25^\circ\text{C}$ Pulse: $f = 10\text{ kHz}$ , Duty cycle = 50%, $I_F = 3\text{ mA}$ , $V_{CC} = 24\text{V}$ , $R_L = 10\text{ k}\Omega$ , $C_L = 15\text{ pF}$ , $V_{THHL} = 2.0\text{V}$	
Common Mode Transient Immunity at Logic High Output <sup>c</sup>	$ CM_H $	15	25	—	$\text{kV}/\mu\text{s}$	$T_A = 25^\circ\text{C}$ $V_{CM} = 1500\text{V}$ , $I_F = 0\text{ mA}$ , $R_L = 1.2\text{ k}\Omega$ or $1.9\text{ k}\Omega$ , $V_{CC} = 3.3\text{ V}$ or $5\text{V}$	27
Common Mode Transient Immunity at Logic Low Output <sup>d</sup>	$ CM_L $	15	20	—	$\text{kV}/\mu\text{s}$	$T_A = 25^\circ\text{C}$ $V_{CM} = 1500\text{V}$ , $I_F = 3\text{ mA}$ , $R_L = 1.2\text{ k}\Omega$ , $V_{CC} = 5\text{V}$	27
		10	15	—	$\text{kV}/\mu\text{s}$	$V_{CM} = 1500\text{V}$ , $I_F = 3\text{ mA}$ , $R_L = 1.2\text{ k}\Omega$ , $V_{CC} = 3.3\text{ V}$	27

- Pulse Width Distortion (PWD) is defined as  $|t_{PHL} - t_{PLH}|$  for any given device.
- The difference between  $t_{PLH}$  and  $t_{PHL}$  between any two parts under the same test condition. (See IPM Dead Time and Propagation Delay Specifications section.)
- Common transient immunity in a Logic High level is the maximum tolerable (positive)  $dV_{CM}/dt$  on the rising edge of the common mode pulse,  $V_{CM}$ , to assure that the output will remain in a Logic High state (i.e.,  $V_O > 2.0\text{V}$ ).
- Common mode transient immunity in a Logic Low level is the maximum tolerable (negative)  $dV_{CM}/dt$  on the falling edge of the common mode pulse signal,  $V_{CM}$  to assure that the output will remain in a Logic Low state (i.e.,  $V_O < 0.8\text{V}$ ).

## Switching Specifications (ACPL-054L/W50L/K54L)

Over recommended temperature ( $T_A = -40^\circ\text{C}$  to  $+105^\circ\text{C}$ ), supply voltage ( $2.7\text{V} \leq V_{CC} \leq 24\text{V}$  unless otherwise specified..

**Table 9 Switching Specifications (ACPL-M50L)**

Parameter	Symbol	Min	Typ	Max	Units	Test Conditions	Fig.
Propagation Delay Time to Logic Low at Output	$T_{PHL}$	—	0.2	0.5	$\mu\text{s}$	$T_A = 25^\circ\text{C}$ Pulse: $f = 10\text{ kHz}$ , Duty cycle = 50%, $I_F = 3\text{ mA}$ , $V_{CC} = 3.3\text{V}$ , $R_L = 1.8\text{ k}\Omega$ , $C_L = 15\text{ pF}$ , $V_{THHL} = 1.5\text{V}$	26
		—	0.2	1	$\mu\text{s}$		13, 26
		—	0.22	0.5	$\mu\text{s}$	$T_A = 25^\circ\text{C}$ Pulse: $f = 10\text{ kHz}$ , Duty cycle = 50%, $I_F = 3\text{ mA}$ , $V_{CC} = 5.0\text{V}$ , $R_L = 2.9\text{ k}\Omega$ , $C_L = 15\text{ pF}$ , $V_{THHL} = 1.5\text{V}$	26
		—	0.22	1	$\mu\text{s}$		15, 26
		—	0.33	0.7	$\mu\text{s}$	$T_A = 25^\circ\text{C}$ Pulse: $f = 10\text{ kHz}$ , Duty cycle = 50%, $I_F = 3\text{ mA}$ , $V_{CC} = 24\text{V}$ , $R_L = 14.8\text{ k}\Omega$ , $C_L = 15\text{ pF}$ , $V_{THHL} = 1.5\text{V}$	26
		—	0.33	1.3	$\mu\text{s}$		17, 26
Propagation Delay Time to Logic High at Output	$T_{PLH}$	—	0.38	0.8	$\mu\text{s}$	$T_A = 25^\circ\text{C}$ Pulse: $f = 10\text{ kHz}$ , Duty cycle = 50%, $I_F = 3\text{ mA}$ , $V_{CC} = 3.3\text{V}$ , $R_L = 1.8\text{ k}\Omega$ , $C_L = 15\text{ pF}$ , $V_{THHL} = 2.0\text{V}$	26
		—	0.38	1.4	$\mu\text{s}$		13, 26
		—	0.31	0.7	$\mu\text{s}$	$T_A = 25^\circ\text{C}$ Pulse: $f = 10\text{ kHz}$ , Duty cycle = 50%, $I_F = 3\text{ mA}$ , $V_{CC} = 5.0\text{V}$ , $R_L = 2.9\text{ k}\Omega$ , $C_L = 15\text{ pF}$ , $V_{THHL} = 2.0\text{V}$	26
		—	0.31	1	$\mu\text{s}$		15, 26
		—	0.3	0.7	$\mu\text{s}$	$T_A = 25^\circ\text{C}$ Pulse: $f = 10\text{ kHz}$ , Duty cycle = 50%, $I_F = 3\text{ mA}$ , $V_{CC} = 24\text{V}$ , $R_L = 14.8\text{ k}\Omega$ , $C_L = 15\text{ pF}$ , $V_{THHL} = 2.0\text{V}$	26
		—	0.3	1	$\mu\text{s}$		17, 26
Pulse Width Distortion <sup>a</sup>	PWD	—	0.18	0.8	$\mu\text{s}$	$T_A = 25^\circ\text{C}$ Pulse: $f = 10\text{ kHz}$ , Duty cycle = 50%, $I_F = 3\text{ mA}$ , $V_{CC} = 3.3\text{V}$ , $R_L = 1.8\text{ k}\Omega$ , $C_L = 15\text{ pF}$ , $V_{THHL} = 1.5\text{V}$ , $V_{THLH} = 2.0\text{V}$	26
		—	0.18	1.4	$\mu\text{s}$		26
		—	0.1	0.7	$\mu\text{s}$	$T_A = 25^\circ\text{C}$ Pulse: $f = 10\text{ kHz}$ , Duty cycle = 50%, $I_F = 3\text{ mA}$ , $V_{CC} = 5.0\text{V}$ , $R_L = 2.9\text{ k}\Omega$ , $C_L = 15\text{ pF}$ , $V_{THHL} = 1.5\text{V}$ , $V_{THLH} = 2.0\text{V}$	26
		—	0.1	1	$\mu\text{s}$		26
		—	0.1	0.7	$\mu\text{s}$	$T_A = 25^\circ\text{C}$ Pulse: $f = 10\text{ kHz}$ , Duty cycle = 50%, $I_F = 3\text{ mA}$ , $V_{CC} = 24\text{V}$ , $R_L = 14.8\text{ k}\Omega$ , $C_L = 15\text{ pF}$ , $V_{THHL} = 1.5\text{V}$ , $V_{THLH} = 2.0\text{V}$	26
		—	0.1	1	$\mu\text{s}$		26
Propagation Delay Difference Between Any Two Parts <sup>b</sup>	$t_{psk}$	—	0.18	0.7	$\mu\text{s}$	$T_A = 25^\circ\text{C}$ Pulse: $f = 10\text{ kHz}$ , Duty cycle = 50%, $I_F = 3\text{ mA}$ , $V_{CC} = 3.3\text{V}$ , $R_L = 1.8\text{ k}\Omega$ , $C_L = 15\text{ pF}$ , $V_{THHL} = 1.5\text{V}$ , $V_{THLH} = 2.0\text{V}$	
		—	0.1	0.6	$\mu\text{s}$	$T_A = 25^\circ\text{C}$ Pulse: $f = 10\text{ kHz}$ , Duty cycle = 50%, $I_F = 3\text{ mA}$ , $V_{CC} = 5.0\text{V}$ , $R_L = 2.9\text{ k}\Omega$ , $C_L = 15\text{ pF}$ , $V_{THHL} = 1.5\text{V}$ , $V_{THLH} = 2.0\text{V}$	
		—	0.1	0.6	$\mu\text{s}$	$T_A = 25^\circ\text{C}$ Pulse: $f = 10\text{ kHz}$ , Duty cycle = 50%, $I_F = 3\text{ mA}$ , $V_{CC} = 24\text{V}$ , $R_L = 14.8\text{ k}\Omega$ , $C_L = 15\text{ pF}$ , $V_{THHL} = 2.0\text{V}$ , $V_{THLH} = 2.0\text{V}$	
Common Mode Transient Immunity at Logic High Output <sup>c</sup>	$ CM_H $	15	25	—	$\text{kV}/\mu\text{s}$	$T_A = 25^\circ\text{C}$ $V_{CM} = 1500\text{V}$ , $I_F = 0\text{ mA}$ , $R_L = 1.8\text{ k}\Omega$ or $2.9\text{ k}\Omega$ , $V_{CC} = 3.3\text{V}$ or $5\text{V}$	27
Common Mode Transient Immunity at Logic Low Output <sup>d</sup>	$ CM_L $	15	20	—	$\text{kV}/\mu\text{s}$	$T_A = 25^\circ\text{C}$ $V_{CM} = 1500\text{V}$ , $I_F = 3\text{ mA}$ , $R_L = 2.9\text{ k}\Omega$ , $V_{CC} = 5\text{V}$	27
		15	20	—	$\text{kV}/\mu\text{s}$	$V_{CM} = 1500\text{V}$ , $I_F = 3\text{ mA}$ , $R_L = 1.8\text{ k}\Omega$ , $V_{CC} = 3.3\text{V}$	27

- Pulse Width Distortion (PWD) is defined as  $|t_{PHL} - t_{PLH}|$  for any given device.
- The difference between  $t_{PLH}$  and  $t_{PHL}$  between any two parts under the same test condition. (See IPM Dead Time and Propagation Delay Specifications section.)
- Common transient immunity in a Logic High level is the maximum tolerable (positive)  $dV_{CM}/dt$  on the rising edge of the common mode pulse,  $V_{CM}$ , to assure that the output will remain in a Logic High state (i.e.,  $V_O > 2.0\text{V}$ ).
- Common mode transient immunity in a Logic Low level is the maximum tolerable (negative)  $dV_{CM}/dt$  on the falling edge of the common mode pulse signal,  $V_{CM}$  to assure that the output will remain in a Logic Low state (i.e.,  $V_O < 0.8\text{V}$ ).

## Package Characteristics

All typical at  $T_A = 25^\circ\text{C}$

**Table 10 Package Characteristics**

Parameter	Symbol	Part Number	Min.	Typ.	Max.	Units	Test Conditions
Input-Output Momentary Withstand Voltage <sup>a, b</sup>	$V_{ISO}$	ACPL-M50L/054L	3750	—	—	Vrms	RH $\leq$ 50%, t = 1 min., $T_A = 25^\circ\text{C}$
		ACPL-W50L/K54L	5000	—	—		
Input-Output Resistance <sup>a</sup>	$R_{I-O}$		—	1014	—	$\Omega$	$V_{I-O} = 500\text{ Vdc}$
Input-Output Capacitance <sup>a</sup>	$C_{I-O}$		—	0.6	—	pF	f = 1 MHz, $T_A = 25^\circ\text{C}$
Input-Input Insulation Leakage Current <sup>[3]</sup>	$I_{I-I}$		—	0.005	—	$\mu\text{A}$	RH $\leq$ 45%, t = 5 s, $V_{I-I} = 500\text{Vdc}$
Input-Input Resistance <sup>c</sup>	$R_{I-I}$		—	1011	—	$\Omega$	
Input-Input Capacitance <sup>c</sup>	$C_{I-I}$		—	0.25	—	pF	f = 1 MHz

- Device considered a two terminal device: pins 1 and 3 shorted together and pins 4, 5 and 6 shorted together for ACPL-M50L, pins 1, 2, 3 and 4 shorted together and pins 5, 6, 7 and 8 shorted together for ACPL-054L/K54L, pins 1, 2 and 3 shorted together and pins 4, 5 and 6 shorted together for ACPL-W50L.
- In accordance with UL 1577, each optocoupler is proof tested by applying an insulation test voltage  $\geq 4500 V_{RMS}$  for 1 second for ACPL-M50L/054L and  $\geq 6000 V_{RMS}$  for 1 second for ACPL-W50L/K54L (leakage detection current limit,  $I_{I-O} \leq 5\text{mA}$ ).
- Measured between pins 1 and 2 shorted together and pins 3 and 4 shorted together for ACPL-054L/K54L.

Figure 7 Input Current vs. Forward Voltage

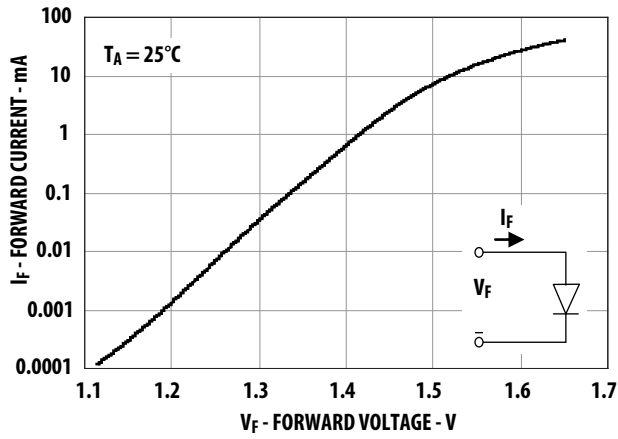

Figure 8 Typical Current Transfer Ratio vs. Temperature

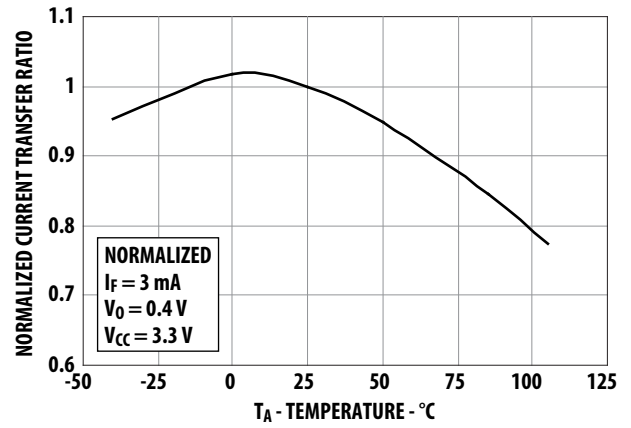

Figure 9 Typical Current Transfer Ratio vs. Temperature

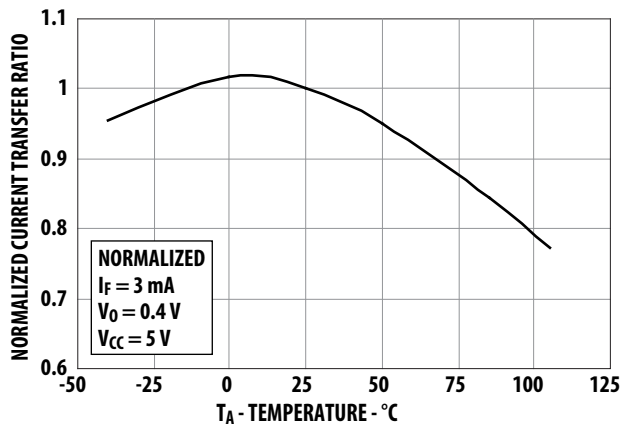

Figure 10 Typical Logic High Output Current vs. Temperature

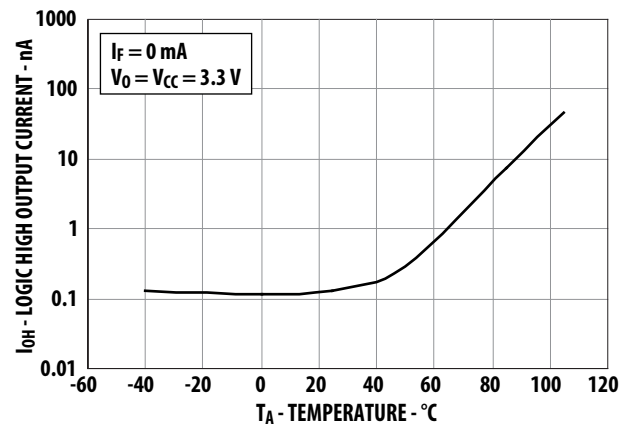
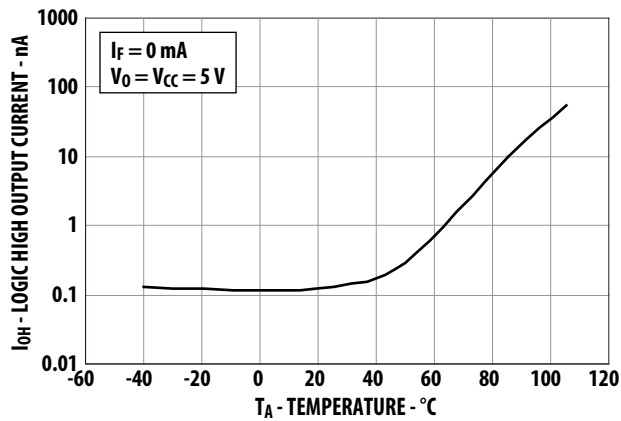
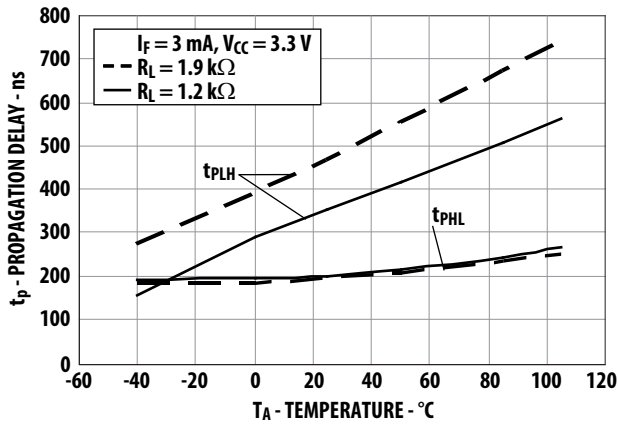

Figure 11 Typical Logic High Output Current vs. Temperature



**Figure 12 Typical Propagation Delay vs. Temperature (ACPL-M50L)**



**Figure 13 Typical Propagation Delay vs. Temperature (ACPL-054L/W50L/K54L)**

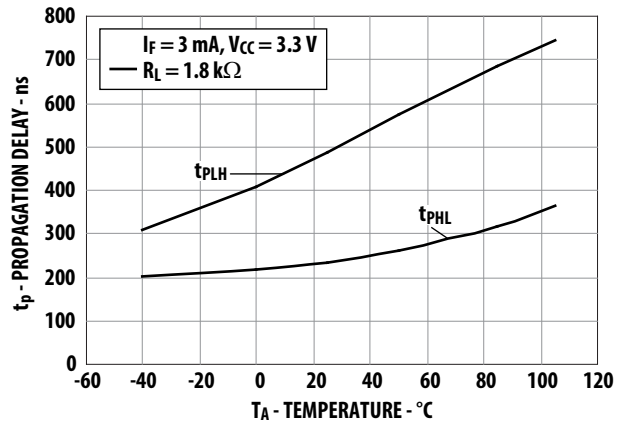

**Figure 14 Typical Propagation Delay vs. Temperature (ACPM-M50L)**

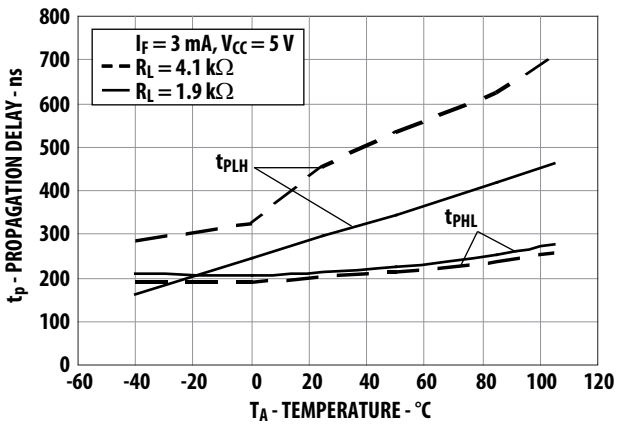

**Figure 15 Typical Propagation Delay vs. Temperature (ACPL-054L/W50L/K54L)**

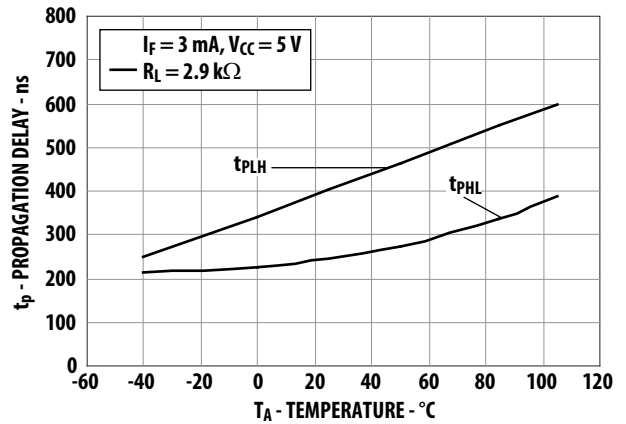

**Figure 16 Typical Propagation Delay vs. Temperature (ACPL-M50L)**

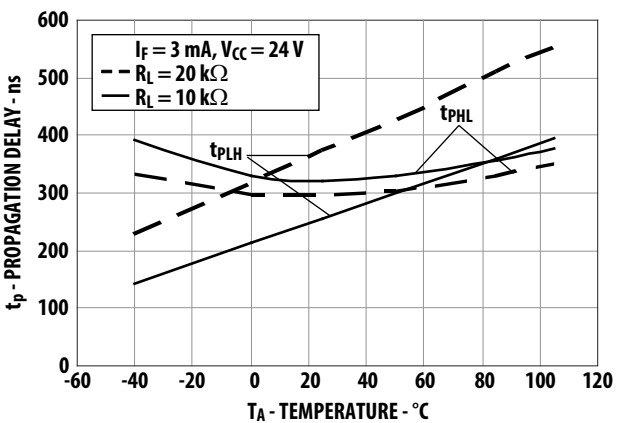

**Figure 17 Typical Propagation Delay vs. Temperature (ACPL-054L/W50L/K54L)**

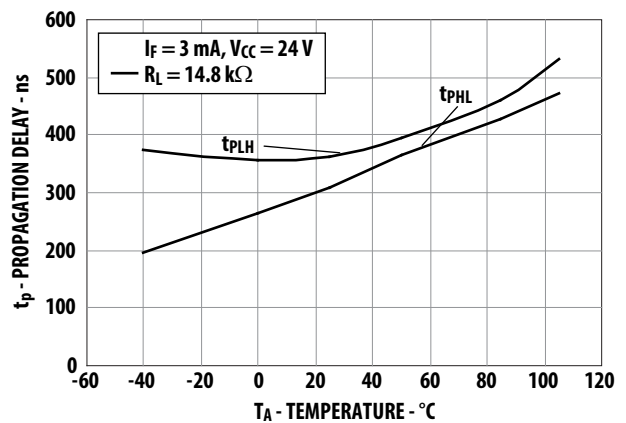

Figure 18 Typical Propagation Delay vs. Load Resistance

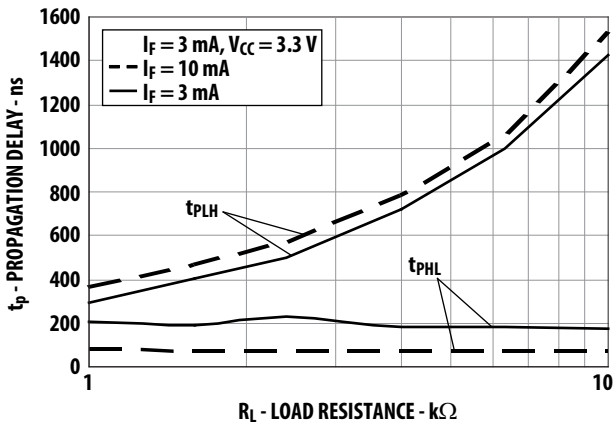

Figure 19 Typical Propagation Delay vs. Load Resistance

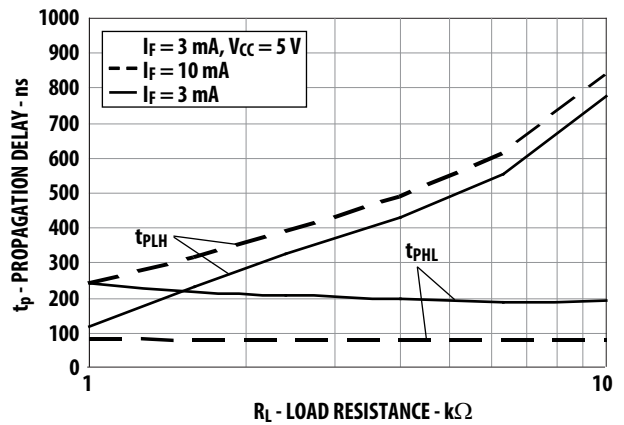

Figure 20 Typical Propagation Delay vs. Load Capacitance (ACPL-M50L)

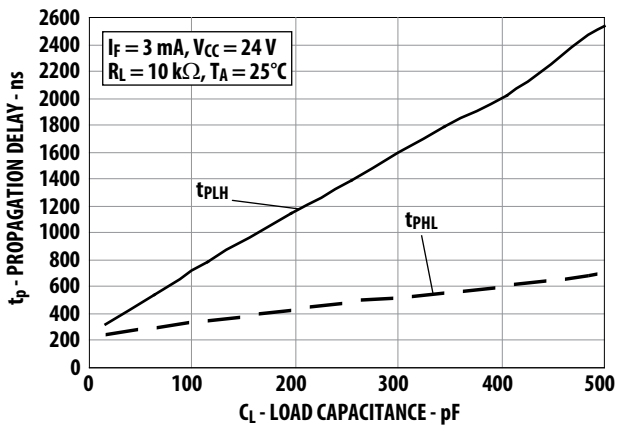

Figure 21 Typical Propagation Delay vs. Load Capacitance (ACPL-054L/W50L/K454L)

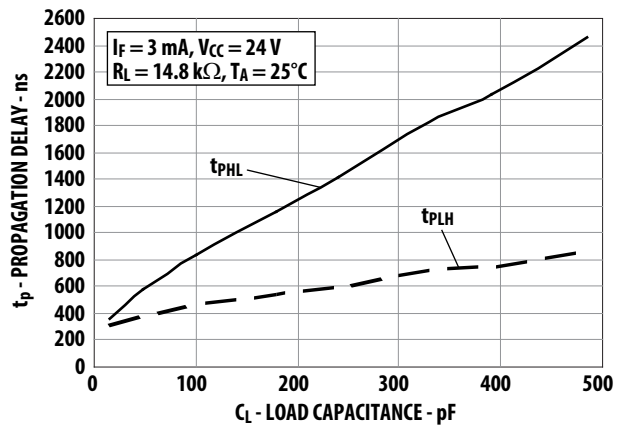

Figure 22 Typical Propagation Delay vs. Supply Voltage (ACPL-M50L)

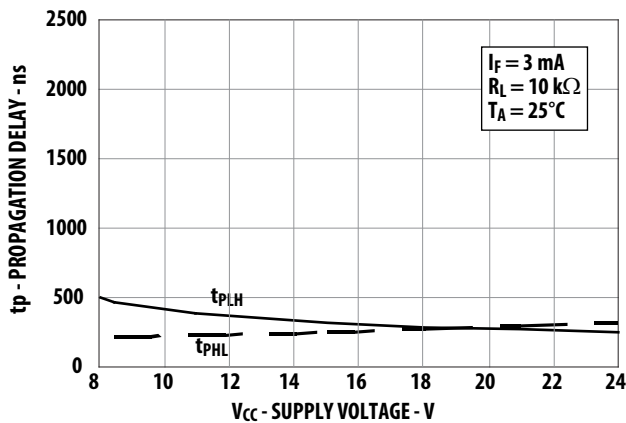
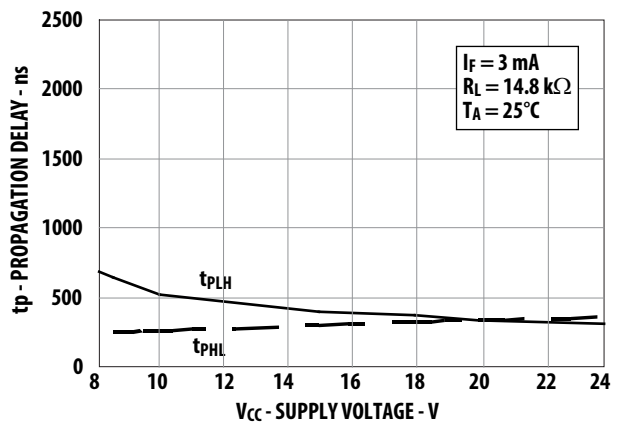
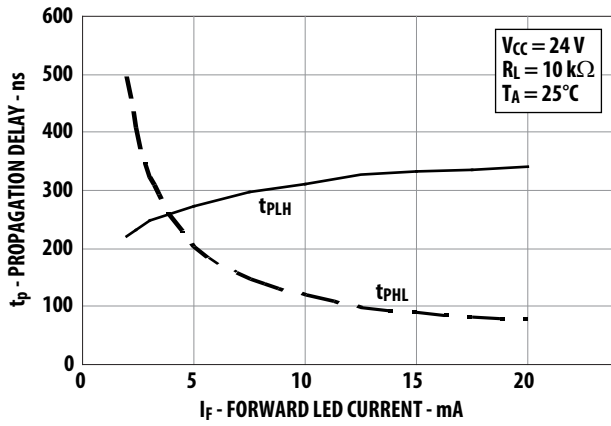

Figure 23 Typical Propagation Delay vs. Supply Voltage (ACPL-054L/W50L/K54L)

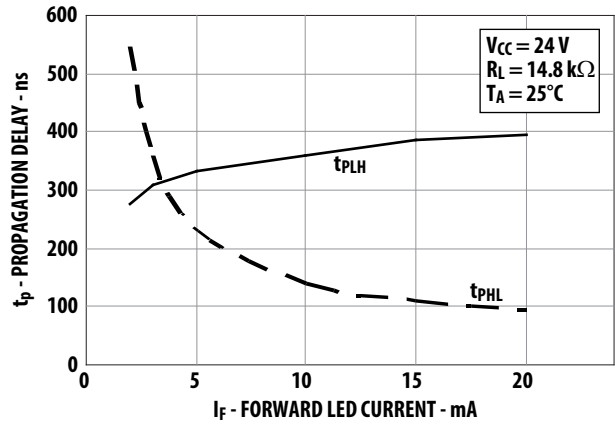



**Figure 24 Typical Propagation Delay vs. Supply Current (ACPL-M50L)**



**Figure 25 Typical Propagation Delay vs. Supply Current (ACPL-054L/W50L/K54L)**



**Figure 26 Switching Test Circuits**

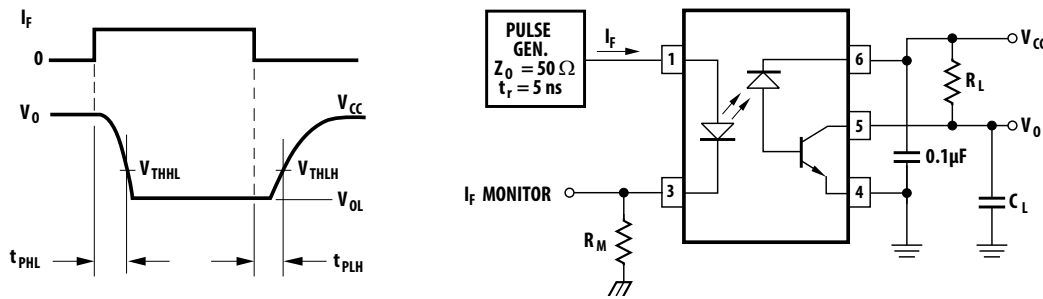

**Figure 27 Test Circuit for Transient Immunity and Typical Waveforms**

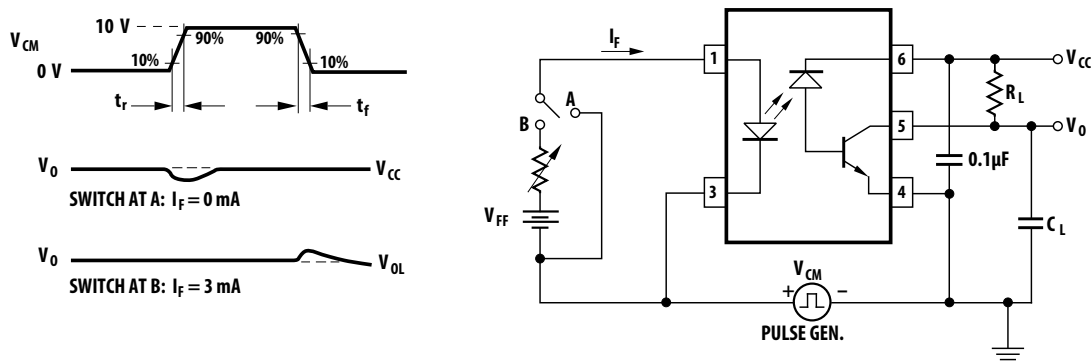

Figure 28 Current Transfer Ratio vs. Input Current

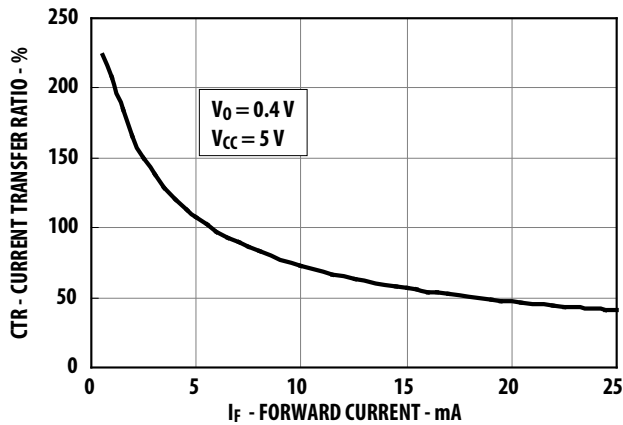
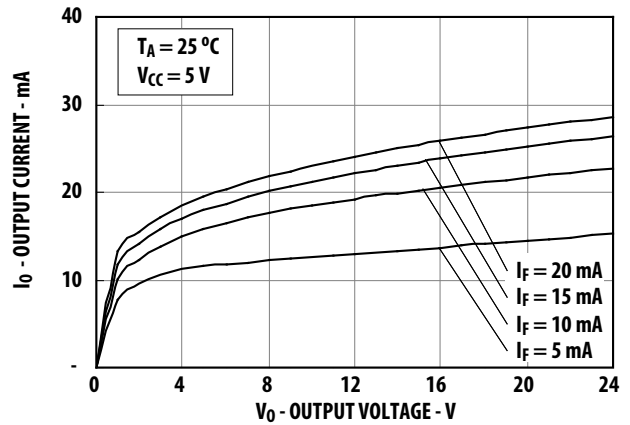

Figure 29 DC Pulse Transfer Characteristic



For product information and a complete list of distributors, please go to our web site: [www.broadcom.com](http://www.broadcom.com).

Broadcom, the pulse logo, Connecting everything, Avago Technologies, Avago, and the A logo are among the trademarks of Broadcom and/or its affiliates in the United States, certain other countries and/or the EU.

Copyright © 2014–2017 by Broadcom. All Rights Reserved.

The term "Broadcom" refers to Broadcom Limited and/or its subsidiaries. For more information, please visit [www.broadcom.com](http://www.broadcom.com).

Broadcom reserves the right to make changes without further notice to any products or data herein to improve reliability, function, or design.

Information furnished by Broadcom is believed to be accurate and reliable. However, Broadcom does not assume any liability arising out of the application or use of this information, nor the application or use of any product or circuit described herein, neither does it convey any license under its patent rights nor the rights of others.

AV02-2223EN – March 10, 2017

