

# Data sheet | Item number: 765-4103/100-000

4-Port-IO Link Master Class A; Profinet; DC 24 V / 2.0 A; 4xM12 connection;  
SlimLine

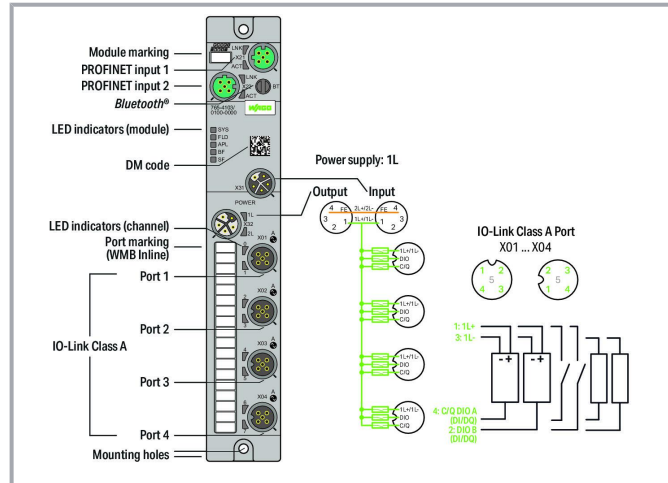

[www.wago.com/765-4103/100-000](http://www.wago.com/765-4103/100-000)



## Data Technical data

### Fieldbus

Communication	PROFINET PROFINET IO Device; 2-port switch, LLDP, MRP, SNMP
Connection technology: communication/fieldbus	2 x D-coded M12; 4-pole
Interface standard	10BASE-T/100BASE-TX; potential-free
Autonegotiation; autocrossover	yes
PROFINET IO properties	PROFINET IO device; 2-port switch, LLDP, MRP, SNMP

### Device Functions

Parameters	Input filter Output current Temperature
Diagnostics	Undervoltage; Overcurrent; Overload; Overtemperature

Subject to changes. Please also observe the further product documentation!

WAGO Kontakttechnik GmbH & Co. KG  
Hansastr. 27  
32423 Minden  
Phone: +49571 887-0 | Fax: +49571 887-169  
Email: [info.de@wago.com](mailto:info.de@wago.com) | Web: [www.wago.com](http://www.wago.com)

Do you have any questions about our products?  
We are always happy to take your call at +49 (571) 887-44222.

Device functions	Bluetooth® OPC UA Server
Visualization	Android/iOS app Webserver

### IO-Link Master

IO-Link Master classification	Class A; Specification V1.1
Port mode	IO-Link: autoconfig, manual, tool-based DI DO
Cycle time	400 µs (min.)
Operating mode	IO-Link master, DI or DO (adjustable for pin 4 per port); DI or DO (adjustable for pin 2 per port)

### IO-Link ports

Number of digital inputs	8
Number of digital outputs	8
Connection technology: inputs/outputs	4 x A-coded M12; 5-pole
Voltage signal type	24 VDC
Input characteristic	High-side switching
Input filter	0.2 ... 20 ms
Input characteristic	Type 3, per IEC 61131-2
Output current (per channel)	2 A (typ.) for DO
Supply current per port	1L: 1 A for IO-Link; 4 A (max.) for DIO

### Module Power Supply

Connection technology: supply	2 x L-coded M12; 5-pole
Supply voltage	24 VDC (18 ... 31.2 V); 1L
Power consumption (max.)	16000 mA
Power consumption (note)	per supply line; overload- and short-circuit-protected
Reverse voltage protection	Yes

### Geometrical Data

Width	35 mm / 1.378 inch
Height	30 mm / 1.181 inch
Depth	210 mm / 8.268 inch

Subject to changes. Please also observe the further product documentation!

## Mechanical Data

Weight	380 g
Conformity marking	CE

## Environmental Requirements



Surrounding air temperature (operation)	-25 ... 70 °C
Surrounding air temperature (storage)	-40 ... 80 °C
Protection type	IP67
Protection class	III per EN 61140, IEC 61140, VDE 0140-1
Operating altitude	0 ... 2000 m
Pollution degree (5)	3 per EN 60664-1
Overvoltage category	II (EN 60664-1)
Relative humidity (without condensation)	95 %
Vibration resistance	5g per IEC 60068-2-6
Shock resistance	Short-term: 50g/11 ms/half-sine per IEC 60068-2-27; Long-term: 30g/6 ms/half-sine per IEC 60068-2-29
EMC immunity to interference	per EN 61000-6-2
EMC emission of interference	per EN 61000-6-4

## Commercial data

PU (SPU)	1 Stück
Packaging type	box
Country of origin	DE
GTIN	4055143950053
Customs tariff number	85371098990

## Required accessories

### Cover

Cover		
	<b>Item no.: 756-8102</b> M12 protective cap; for unused sockets	<a href="http://www.wago.com/756-8102">www.wago.com/756-8102</a>
	<b>Item no.: 756-8103</b> M12 protective cap; for unused plugs	<a href="http://www.wago.com/756-8103">www.wago.com/756-8103</a>

### Marking accessories

Marking strip	
---------------	--

Subject to changes. Please also observe the further product documentation!



**Item no.: 2009-110**

Marking strips; for Smart Printer; on reel; not stretchable; plain; snap-on type; white

[www.wago.com/2009-110](http://www.wago.com/2009-110)

Marker



**Item no.: 2009-115**

WMB-Inline; for Smart Printer; 1500 pieces on roll; stretchable 5 - 5.2 mm; plain; snap-on type; white

[www.wago.com/2009-115](http://www.wago.com/2009-115)

Tool

Assembly tool



**Item no.: 206-701**

Torque wrench M8 and M12; Assembly kit

[www.wago.com/206-701](http://www.wago.com/206-701)

## Optional accessories

### Cables and pluggable connectors

Sensor/actuator cable



**Item no.: 756-5402/040-010**

Sensor/Actuator cable; M12A socket; straight; M12A plug; angled; 4-pole; Length: 1 m

[www.wago.com/756-5402/040-010](http://www.wago.com/756-5402/040-010)



**Item no.: 756-5402/040-020**

Sensor/Actuator cable; M12A socket; straight; M12A plug; angled; 4-pole; Length: 2 m

[www.wago.com/756-5402/040-020](http://www.wago.com/756-5402/040-020)



**Item no.: 756-5311/040-050**

Sensor/Actuator cable; M12A plug; straight; 4-pole; Length: 5 m

[www.wago.com/756-5311/040-050](http://www.wago.com/756-5311/040-050)



**Item no.: 756-5311/040-015**

Sensor/Actuator cable; M12A plug; straight; 4-pole; Length: 1.5 m

[www.wago.com/756-5311/040-015](http://www.wago.com/756-5311/040-015)



**Item no.: 756-5311/040-100**

Sensor/Actuator cable; M12A plug; straight; 4-pole; Length: 10 m

[www.wago.com/756-5311/040-100](http://www.wago.com/756-5311/040-100)



**Item no.: 756-5404/040-020**

Sensor/Actuator cable; M12A socket; angled; M12A plug; angled; 4-pole; Length: 2 m

[www.wago.com/756-5404/040-020](http://www.wago.com/756-5404/040-020)



**Item no.: 756-5510/040-010**

Sensor/Actuator cable; M8 socket; angled; M12A plug; angled; 4-pole; Length: 1 m

[www.wago.com/756-5510/040-010](http://www.wago.com/756-5510/040-010)



**Item no.: 756-5510/040-020**

Sensor/Actuator cable; M8 socket; angled; M12A plug; angled; 4-pole; Length: 2 m

[www.wago.com/756-5510/040-020](http://www.wago.com/756-5510/040-020)

Subject to changes. Please also observe the further product documentation!

WAGO Kontakttechnik GmbH & Co. KG

Hansastr. 27













32423 Minden

Phone: +49571 887-0 | Fax: +49571 887-169

Email: [info.de@wago.com](mailto:info.de@wago.com) | Web: [www.wago.com](http://www.wago.com)

Do you have any questions about our products?

We are always happy to take your call at +49 (571) 887-44222.

	<b>Item no.: 756-5401/040-020</b> Sensor/Actuator cable; M12A socket; straight; M12A plug; straight; 4-pole; Length: 2 m	<a href="http://www.wago.com/756-5401/040-020">www.wago.com/756-5401/040-020</a>
	<b>Item no.: 756-5401/040-010</b> Sensor/Actuator cable; M12A socket; straight; M12A plug; straight; 4-pole; Length: 1 m	<a href="http://www.wago.com/756-5401/040-010">www.wago.com/756-5401/040-010</a>
	<b>Item no.: 756-5507/040-010</b> Sensor/Actuator cable; M8 socket; straight; M12A plug; straight; 4-pole; Length: 1 m	<a href="http://www.wago.com/756-5507/040-010">www.wago.com/756-5507/040-010</a>
	<b>Item no.: 756-5507/040-020</b> Sensor/Actuator cable; M8 socket; straight; M12A plug; straight; 4-pole; Length: 2 m	<a href="http://www.wago.com/756-5507/040-020">www.wago.com/756-5507/040-020</a>
	<b>Item no.: 756-5404/040-010</b> Sensor/Actuator cable; M12A socket; angled; M12A plug; angled; 4-pole; Length: 1 m	<a href="http://www.wago.com/756-5404/040-010">www.wago.com/756-5404/040-010</a>
	<b>Item no.: 756-5312/040-015</b> Sensor/Actuator cable; M12B socket; straight; 4-pole; Length: 1.5 m	<a href="http://www.wago.com/756-5312/040-015">www.wago.com/756-5312/040-015</a>
	<b>Item no.: 756-5312/040-050</b> Sensor/Actuator cable; M12B socket; straight; 4-pole; Length: 5 m	<a href="http://www.wago.com/756-5312/040-050">www.wago.com/756-5312/040-050</a>
	<b>Item no.: 756-5509/040-010</b> Sensor/Actuator cable; M8 socket; angled; M12A plug; straight; 4-pole; Length: 1 m	<a href="http://www.wago.com/756-5509/040-010">www.wago.com/756-5509/040-010</a>
	<b>Item no.: 756-5509/040-020</b> Sensor/Actuator cable; M8 socket; angled; M12A plug; straight; 4-pole; Length: 2 m	<a href="http://www.wago.com/756-5509/040-020">www.wago.com/756-5509/040-020</a>
	<b>Item no.: 756-5403/040-010</b> Sensor/Actuator cable; M12A socket; angled; M12A plug; straight; 4-pole; Length: 1 m	<a href="http://www.wago.com/756-5403/040-010">www.wago.com/756-5403/040-010</a>
	<b>Item no.: 756-5312/040-100</b> Sensor/Actuator cable; M12B socket; straight; 4-pole; Length: 10 m	<a href="http://www.wago.com/756-5312/040-100">www.wago.com/756-5312/040-100</a>
	<b>Item no.: 756-5403/040-020</b> Sensor/Actuator cable; M12A socket; angled; M12A plug; straight; 4-pole; Length: 2 m	<a href="http://www.wago.com/756-5403/040-020">www.wago.com/756-5403/040-020</a>
	<b>Item no.: 756-5508/040-010</b> Sensor/Actuator cable; M8 socket; straight; M12A plug; angled; 4-pole; Length: 1 m	<a href="http://www.wago.com/756-5508/040-010">www.wago.com/756-5508/040-010</a>

Subject to changes. Please also observe the further product documentation!



**Item no.:** 756-5508/040-020

Sensor/Actuator cable; M8 socket; straight; M12A plug; angled; 4-pole; Length: 2 m

[www.wago.com/756-5508/040-020](http://www.wago.com/756-5508/040-020)

---

Configurable connectors



**Item no.:** 756-9202/040-000

Fitted pluggable connector; 4-pole; M12 plug, straight, A-coded; Spring

[www.wago.com/756-9202/040-000](http://www.wago.com/756-9202/040-000)



**Item no.:** 756-9205/040-000

Fitted pluggable connector; 4-pole; M12 plug, right angle; Spring

[www.wago.com/756-9205/040-000](http://www.wago.com/756-9205/040-000)



**Item no.:** 756-9711/050-000

Fitted pluggable connector; 5-pole, shielded; M12 socket, straight; IDC technology

[www.wago.com/756-9711/050-000](http://www.wago.com/756-9711/050-000)



**Item no.:** 756-9701/050-000

Fitted pluggable connector; 5-pole, shielded; M12 plug, straight; IDC technology

[www.wago.com/756-9701/050-000](http://www.wago.com/756-9701/050-000)

---

Configurable shielded connectors



**Item no.:** 756-9501/060-000

Fitted pluggable connector; 5-pole, shielded; M12 plug, straight, D-coded; Spring

[www.wago.com/756-9501/060-000](http://www.wago.com/756-9501/060-000)



**Item no.:** 756-9501/040-000

Accessories; M12 plug, right angle; 4-pole

[www.wago.com/756-9501/040-000](http://www.wago.com/756-9501/040-000)

---

Power cable



**Item no.:** 756-3501/050-075

Power cable; M12L socket; straight; 5-pole; Length: 7.5 m

[www.wago.com/756-3501/050-075](http://www.wago.com/756-3501/050-075)



**Item no.:** 756-3501/050-100

Power cable; M12L socket; straight; 5-pole; Length: 10 m

[www.wago.com/756-3501/050-100](http://www.wago.com/756-3501/050-100)



**Item no.:** 756-3501/050-150

Power cable; M12L socket; straight; 5-pole; Length: 15 m

[www.wago.com/756-3501/050-150](http://www.wago.com/756-3501/050-150)



**Item no.:** 756-3501/050-050

Power cable; M12L socket; straight; 5-pole; Length: 5 m

[www.wago.com/756-3501/050-050](http://www.wago.com/756-3501/050-050)

---

Subject to changes. Please also observe the further product documentation!



**Item no.: 756-3502/050-050**  
Power cable; M12L socket; angled; 5-pole; Length: 5 m

[www.wago.com/756-3502/050-050](http://www.wago.com/756-3502/050-050)



**Item no.: 756-3502/050-150**  
Power cable; M12L socket; angled; 5-pole; Length: 15 m

[www.wago.com/756-3502/050-150](http://www.wago.com/756-3502/050-150)



**Item no.: 756-3502/050-075**  
Power cable; M12L socket; angled; 5-pole; Length: 7.5 m

[www.wago.com/756-3502/050-075](http://www.wago.com/756-3502/050-075)



**Item no.: 756-3502/050-100**  
Power cable; M12L socket; angled; 5-pole; Length: 10 m

[www.wago.com/756-3502/050-100](http://www.wago.com/756-3502/050-100)



**Item no.: 756-3503/050-075**  
Power cable; M12L plug; straight; 5-pole; Length: 7.5 m

[www.wago.com/756-3503/050-075](http://www.wago.com/756-3503/050-075)



**Item no.: 756-3503/050-150**  
Power cable; M12L plug; straight; 5-pole; Length: 15 m

[www.wago.com/756-3503/050-150](http://www.wago.com/756-3503/050-150)



**Item no.: 756-3503/050-100**  
Power cable; M12L plug; straight; 5-pole; Length: 10 m

[www.wago.com/756-3503/050-100](http://www.wago.com/756-3503/050-100)



**Item no.: 756-3505/050-003**  
Power cable; M12L socket; straight; M12L plug; straight; 5-pole; Length: 0.3 m

[www.wago.com/756-3505/050-003](http://www.wago.com/756-3505/050-003)



**Item no.: 756-3505/050-005**  
Power cable; M12L socket; straight; M12L plug; straight; 5-pole; Length: 0.5 m

[www.wago.com/756-3505/050-005](http://www.wago.com/756-3505/050-005)



**Item no.: 756-3505/050-020**  
Power cable; M12L socket; straight; M12L plug; straight; 5-pole; Length: 2 m

[www.wago.com/756-3505/050-020](http://www.wago.com/756-3505/050-020)



**Item no.: 756-3505/050-010**  
Power cable; M12L socket; straight; M12L plug; straight; 5-pole; Length: 1 m













[www.wago.com/756-3505/050-010](http://www.wago.com/756-3505/050-010)



**Item no.: 756-3505/050-050**  
Power cable; M12L socket; straight; M12L plug; straight; 5-pole; Length: 5 m













[www.wago.com/756-3505/050-050](http://www.wago.com/756-3505/050-050)

Subject to changes. Please also observe the further product documentation!

	<b>Item no.: 756-3505/050-075</b> Power cable; M12L socket; straight; M12L plug; straight; 5-pole; Length: 7.5 m	<a href="http://www.wago.com/756-3505/050-075">www.wago.com/756-3505/050-075</a>
	<b>Item no.: 756-3505/050-100</b> Power cable; M12L socket; straight; M12L plug; straight; 5-pole; Length: 10 m	<a href="http://www.wago.com/756-3505/050-100">www.wago.com/756-3505/050-100</a>
	<b>Item no.: 756-3506/050-100</b> Power cable; M12L socket; angled; M12L plug; angled; 5-pole; Length: 10 m	<a href="http://www.wago.com/756-3506/050-100">www.wago.com/756-3506/050-100</a>
	<b>Item no.: 756-3506/050-075</b> Power cable; M12L socket; angled; M12L plug; angled; 5-pole; Length: 7.5 m	<a href="http://www.wago.com/756-3506/050-075">www.wago.com/756-3506/050-075</a>
	<b>Item no.: 756-3506/050-150</b> Power cable; M12L socket; angled; M12L plug; angled; 5-pole; Length: 15 m	<a href="http://www.wago.com/756-3506/050-150">www.wago.com/756-3506/050-150</a>
	<b>Item no.: 756-3501/050-020</b> Power cable; M12L socket; straight; 5-pole; Length: 2 m	<a href="http://www.wago.com/756-3501/050-020">www.wago.com/756-3501/050-020</a>
	<b>Item no.: 756-3502/050-020</b> Power cable; M12L socket; angled; 5-pole; Length: 2 m	<a href="http://www.wago.com/756-3502/050-020">www.wago.com/756-3502/050-020</a>
	<b>Item no.: 756-3503/050-020</b> Power cable; M12L plug; straight; 5-pole; Length: 2 m	<a href="http://www.wago.com/756-3503/050-020">www.wago.com/756-3503/050-020</a>
	<b>Item no.: 756-3503/050-050</b> Power cable; M12L plug; straight; 5-pole; Length: 5 m	<a href="http://www.wago.com/756-3503/050-050">www.wago.com/756-3503/050-050</a>
	<b>Item no.: 756-3504/050-020</b> Power cable; M12L plug; angled; 5-pole; Length: 2 m	<a href="http://www.wago.com/756-3504/050-020">www.wago.com/756-3504/050-020</a>
	<b>Item no.: 756-3504/050-050</b> Power cable; M12L plug; angled; 5-pole; Length: 5 m	<a href="http://www.wago.com/756-3504/050-050">www.wago.com/756-3504/050-050</a>
	<b>Item no.: 756-3504/050-075</b> Power cable; M12L plug; angled; 5-pole; Length: 7.5 m	<a href="http://www.wago.com/756-3504/050-075">www.wago.com/756-3504/050-075</a>

Subject to changes. Please also observe the further product documentation!



	<b>Item no.: 756-3504/050-100</b> Power cable; M12L plug; angled; 5-pole; Length: 10 m	<a href="http://www.wago.com/756-3504/050-100">www.wago.com/756-3504/050-100</a>
	<b>Item no.: 756-3504/050-150</b> Power cable; M12L plug; angled; 5-pole; Length: 15 m	<a href="http://www.wago.com/756-3504/050-150">www.wago.com/756-3504/050-150</a>
	<b>Item no.: 756-3505/050-150</b> Power cable; M12L socket; straight; M12L plug; straight; 5-pole; Length: 15 m	<a href="http://www.wago.com/756-3505/050-150">www.wago.com/756-3505/050-150</a>
	<b>Item no.: 756-3506/050-003</b> Power cable; M12L socket; angled; M12L plug; angled; 5-pole; Length: 0.3 m	<a href="http://www.wago.com/756-3506/050-003">www.wago.com/756-3506/050-003</a>
	<b>Item no.: 756-3506/050-005</b> Power cable; M12L socket; angled; M12L plug; angled; 5-pole; Length: 0.5 m	<a href="http://www.wago.com/756-3506/050-005">www.wago.com/756-3506/050-005</a>
	<b>Item no.: 756-3506/050-020</b> Power cable; M12L socket; angled; M12L plug; angled; 5-pole; Length: 2 m	<a href="http://www.wago.com/756-3506/050-020">www.wago.com/756-3506/050-020</a>
	<b>Item no.: 756-3506/050-010</b> Power cable; M12L socket; angled; M12L plug; angled; 5-pole; Length: 1 m	<a href="http://www.wago.com/756-3506/050-010">www.wago.com/756-3506/050-010</a>
	<b>Item no.: 756-3506/050-050</b> Power cable; M12L socket; angled; M12L plug; angled; 5-pole; Length: 5 m	<a href="http://www.wago.com/756-3506/050-050">www.wago.com/756-3506/050-050</a>
Distribution connector		
	<b>Item no.: 756-5513/040-010</b> Sensor/Actuator cable; 2xM8 socket; straight; M12A plug; straight; 4-pole; Length: 1 m	<a href="http://www.wago.com/756-5513/040-010">www.wago.com/756-5513/040-010</a>
	<b>Item no.: 756-5513/040-020</b> Sensor/Actuator cable; 2xM8 socket; straight; M12A plug; straight; 4-pole; Length: 2 m	<a href="http://www.wago.com/756-5513/040-020">www.wago.com/756-5513/040-020</a>
	<b>Item no.: 756-5514/040-010</b> Sensor/Actuator cable; 2xM8 socket; angled; M12A plug; straight; 4-pole; Length: 1 m	<a href="http://www.wago.com/756-5514/040-010">www.wago.com/756-5514/040-010</a>
	<b>Item no.: 756-5514/040-020</b> Sensor/Actuator cable; 2xM8 socket; angled; M12A plug; straight; 4-pole; Length: 2 m	<a href="http://www.wago.com/756-5514/040-020">www.wago.com/756-5514/040-020</a>
	<b>Item no.: 756-5516/040-010</b> Sensor/Actuator cable; 2xM12 socket; straight; M12A plug; straight; 4-pole; Length: 1 m	<a href="http://www.wago.com/756-5516/040-010">www.wago.com/756-5516/040-010</a>

Subject to changes. Please also observe the further product documentation!



**Item no.: 756-5516/040-020**  
Sensor/Actuator cable; 2xM12 socket; straight; M12A plug; straight; 4-pole; Length: 2 m

[www.wago.com/756-5516/040-020](http://www.wago.com/756-5516/040-020)



**Item no.: 756-5517/040-010**  
Sensor/Actuator cable; 2xM12 socket; angled; M12A plug; straight; 4-pole; Length: 1 m

[www.wago.com/756-5517/040-010](http://www.wago.com/756-5517/040-010)



**Item no.: 756-5517/040-020**  
Sensor/Actuator cable; 2xM12 socket; angled; M12A plug; straight; 4-pole; Length: 2 m

[www.wago.com/756-5517/040-020](http://www.wago.com/756-5517/040-020)



**Item no.: 756-9301/050-000**  
Accessories; 5-pole

[www.wago.com/756-9301/050-000](http://www.wago.com/756-9301/050-000)



**Item no.: 756-9301/040-000**  
Accessories; 4-pole

[www.wago.com/756-9301/040-000](http://www.wago.com/756-9301/040-000)

#### Adapter



**Item no.: 756-9503/040-000**  
Accessories; 4-pole

[www.wago.com/756-9503/040-000](http://www.wago.com/756-9503/040-000)



**Item no.: 756-9504/040-000**  
Accessories; 4-pole

[www.wago.com/756-9504/040-000](http://www.wago.com/756-9504/040-000)

#### ETHERNET/PROFINET cable



**Item no.: 756-1202/060-200**  
ETHERNET cable; M12D plug; angled; 4-pole; Length: 20 m

[www.wago.com/756-1202/060-200](http://www.wago.com/756-1202/060-200)



**Item no.: 756-1201/060-100**  
ETHERNET cable; M12D plug; straight; 4-pole; Length: 10 m

[www.wago.com/756-1201/060-100](http://www.wago.com/756-1201/060-100)



**Item no.: 756-1201/060-050**  
ETHERNET cable; M12D plug; straight; 4-pole; Length: 5 m













[www.wago.com/756-1201/060-050](http://www.wago.com/756-1201/060-050)



**Item no.: 756-1203/060-050**  
ETHERNET cable; M12D plug; straight; M12D plug; straight; 4-pole; Length: 5 m

[www.wago.com/756-1203/060-050](http://www.wago.com/756-1203/060-050)

Subject to changes. Please also observe the further product documentation!

	<b>Item no.: 756-1203/060-020</b> ETHERNET cable; M12D plug; straight; M12D plug; straight; 4-pole; Length: 2 m	<a href="http://www.wago.com/756-1203/060-020">www.wago.com/756-1203/060-020</a>
	<b>Item no.: 756-1202/060-020</b> ETHERNET cable; M12D plug; angled; 4-pole; Length: 2 m	<a href="http://www.wago.com/756-1202/060-020">www.wago.com/756-1202/060-020</a>
	<b>Item no.: 756-1201/060-200</b> ETHERNET cable; M12D plug; straight; 4-pole; Length: 20 m	<a href="http://www.wago.com/756-1201/060-200">www.wago.com/756-1201/060-200</a>
	<b>Item no.: 756-1204/060-050</b> ETHERNET cable; M12D plug; angled; M12D plug; angled; 4-pole; Length: 5 m	<a href="http://www.wago.com/756-1204/060-050">www.wago.com/756-1204/060-050</a>
	<b>Item no.: 756-1204/060-100</b> ETHERNET cable; M12D plug; angled; M12D plug; angled; 4-pole; Length: 10 m	<a href="http://www.wago.com/756-1204/060-100">www.wago.com/756-1204/060-100</a>
	<b>Item no.: 756-1204/060-200</b> ETHERNET cable; M12D plug; angled; M12D plug; angled; 4-pole; Length: 20 m	<a href="http://www.wago.com/756-1204/060-200">www.wago.com/756-1204/060-200</a>
	<b>Item no.: 756-1203/060-200</b> ETHERNET cable; M12D plug; straight; M12D plug; straight; 4-pole; Length: 20 m	<a href="http://www.wago.com/756-1203/060-200">www.wago.com/756-1203/060-200</a>
	<b>Item no.: 756-1203/060-100</b> ETHERNET cable; M12D plug; straight; M12D plug; straight; 4-pole; Length: 10 m	<a href="http://www.wago.com/756-1203/060-100">www.wago.com/756-1203/060-100</a>
	<b>Item no.: 756-1204/060-010</b> ETHERNET cable; M12D plug; angled; M12D plug; angled; 4-pole; Length: 0.1 m	<a href="http://www.wago.com/756-1204/060-010">www.wago.com/756-1204/060-010</a>
	<b>Item no.: 756-1204/060-030</b> ETHERNET cable; M12D plug; angled; M12D plug; angled; 4-pole; Length: 3 m	<a href="http://www.wago.com/756-1204/060-030">www.wago.com/756-1204/060-030</a>
	<b>Item no.: 756-1204/060-020</b> ETHERNET cable; M12D plug; angled; M12D plug; angled; 4-pole; Length: 2 m	<a href="http://www.wago.com/756-1204/060-020">www.wago.com/756-1204/060-020</a>
	<b>Item no.: 756-1202/060-050</b> ETHERNET cable; M12D plug; angled; 4-pole; Length: 5 m	<a href="http://www.wago.com/756-1202/060-050">www.wago.com/756-1202/060-050</a>

Subject to changes. Please also observe the further product documentation!



Item no.: 756-1202/060-100  
ETHERNET cable; M12D plug; angled; 4-pole; Length: 10 m

[www.wago.com/756-1202/060-100](http://www.wago.com/756-1202/060-100)



Item no.: 756-1201/060-020  
ETHERNET cable; M12D plug; straight; 4-pole; Length: 2 m

[www.wago.com/756-1201/060-020](http://www.wago.com/756-1201/060-020)

## Downloads

### Documentation

#### Manual

4-Port IO-Link Master Class A; Profinet DC 24 V / 2.0 A; 4xM12 Connection; SlimLine	V 2.1.0 2020. 11. 30.	pdf 4.2 MB	Download
--	--------------------------	---------------	----------

#### System Description

WAGO I/O System Field; General Product Information		pdf 708.2 kB	Download
--	--	-----------------	----------

## Engineering-Software

### WAGO IO-Link Configurator

WAGO IO-Link Configurator	V5.1.1-6015 2021. 8. 24.	ZIP 159.6 MB	Download
---------------------------	-----------------------------	-----------------	----------

WAGO IO-Link Configurator allows configuration, parameterization, operation and monitoring of WAGO IO-Link Masters in the WAGO I/O System 750 and WAGO I/O System Field, and especially of the WAGO IO-Link devices connected to them.

Additionally, WAGO IO-Link Configurator can be used for complete configuration and operation of all IO-Link devices of third-party manufacturers, as long as they comply with the IO-Link specification. A product's process data can be visualized graphically and stored in trend curves. Up to eight elements can be selected for visualization, and the data can be recorded for up to 24 hours.

Device description files for the IO-Link Masters (IOLM) or IO-Link Devices (IODD) can be used to integrate new devices into the tool at any time. Convenient access to the IO-Link user organization's IODDfinder is available for the IODDs. This allows automated, selective download of IODDs when integrating new IO-Link devices. An integrated IODD viewer allows detailed insight into the IODD device description.

WAGO IO-Link Configurator can be used either as a standalone program or integrated into engineering systems with a TCI interface and WAGO-I/O-CHECK.

IO-Link Configurator can also be used to integrate the IO-Link Master (750-657) of the WAGO I/O System 750 Series and to access all the configurator's functions. This is made possible by the WAGO I/O System 750 IO-Link Adapter, which can be retrofitted. The WAGO I/O System 750 IO-Link Adapter requires the current version of WAGO IO-Link Configurator and a current version of WAGO-I/O-CHECK.

In addition, the download file contains the device descriptions for the respective fieldbus systems of the WAGO I/O System Field modules. These are pre-installed in the Configurator setup.

The WAGO IO-Link Configurator license is assigned to the specific PC on which it is installed (a workstation license).

Subject to changes. Please also observe the further product documentation!

WAGO Kontakttechnik GmbH & Co. KG

Hansastr. 27

32423 Minden

Phone: +49571 887-0 | Fax: +49571 887-169

Email: [info.de@wago.com](mailto:info.de@wago.com) | Web: [www.wago.com](http://www.wago.com)

Do you have any questions about our products?

We are always happy to take your call at +49 (571) 887-44222.



installed (a versionation history).

Register now and test our engineering software for 30 days at no cost.

## CAD/CAE-Data

### CAD data

2D/3D Models 765-4103/100-000	URL	Download
-------------------------------	-----	----------

### CAE data

ZUKEN Portal 765-4103/100-000	URL	Download
-------------------------------	-----	----------

## Device Files

### Device Description File

750-916; GSD-Dateien der Version 2.x für PROFINET/ Serie 750/753, 765, 767 und 852	2.81 2021. 4. 15.	zip 2.4 MB	Download
--	----------------------	---------------	----------

Gerätebeschreibungdateien 765-41xx, 765-11xx, PROFINET	V1_1_0_20	zip 27 B	Download
--	-----------	-------------	----------

## Environmental Product Compliance

### Compliance Search

Environmental Product Compliance 765-4103/100-000 4-Port-IO Link Master Class A; Profinet; DC 24 V / 2.0 A; 4xM12 connection; SlimLine	URL	Download
---	-----	----------

## Installation Notes

## Product family

### I/O System Field

Show all products from the family

Subject to changes. Please also observe the further product documentation!