

DESCRIPTION

The EV6507GQ-00A is an evaluation board for the MP6507GQ, a bipolar stepper motor driver with dual, built-in full-bridges consisting of N-channel power MOSFETs.

It operates from a supply voltage range of 2.7V to 15V, and can deliver output current up to 700mA per channel. The safety features include sinking and sourcing current limits implemented with external sensors, under-voltage lockout and thermal shutdown. An over-temperature output flag is available to indicate thermal shutdown.

The EV6507GQ-00A is a fully assembled and tested PCB. The input control signals for the MP6507GQ are applied through the connector or generated on board. It can drive a bipolar stepper motor with both full step and half step mode. It also can drive two independent DC motors.

ELECTRICAL SPECIFICATION

Parameter	Symbol	Value	Units
Input Voltage	V_{IN}	2.7 – 15	V
Output Current	I_{OUT}	500	mA

FEATURES

- Wide 2.7V to 15V Input Voltage Range
- Over-Temperature Indication
- Alternative Input Control Singals (External or Generated on Board)

APPLICATIONS

- POS Printers
- Video Security Camera
- Battery Powered Devices
- USB Powered Devices

All MPS parts are lead-free and adhere to the RoHS directive. For MPS green status, please visit MPS website under Products, Quality Assurance page.

"MPS" and "The Future of Analog IC Technology", are Registered Trademarks of Monolithic Power Systems, Inc.

EV6507GQ-00A EVALUATION BOARD



(L x W x H) 2" x 2" x 0.4" (5cm x 5cm x 1cm)

Board Number	MPS IC Number
EV6507GQ-00A	MP6507GQ

EVALUATION BOARD SCHEMATIC

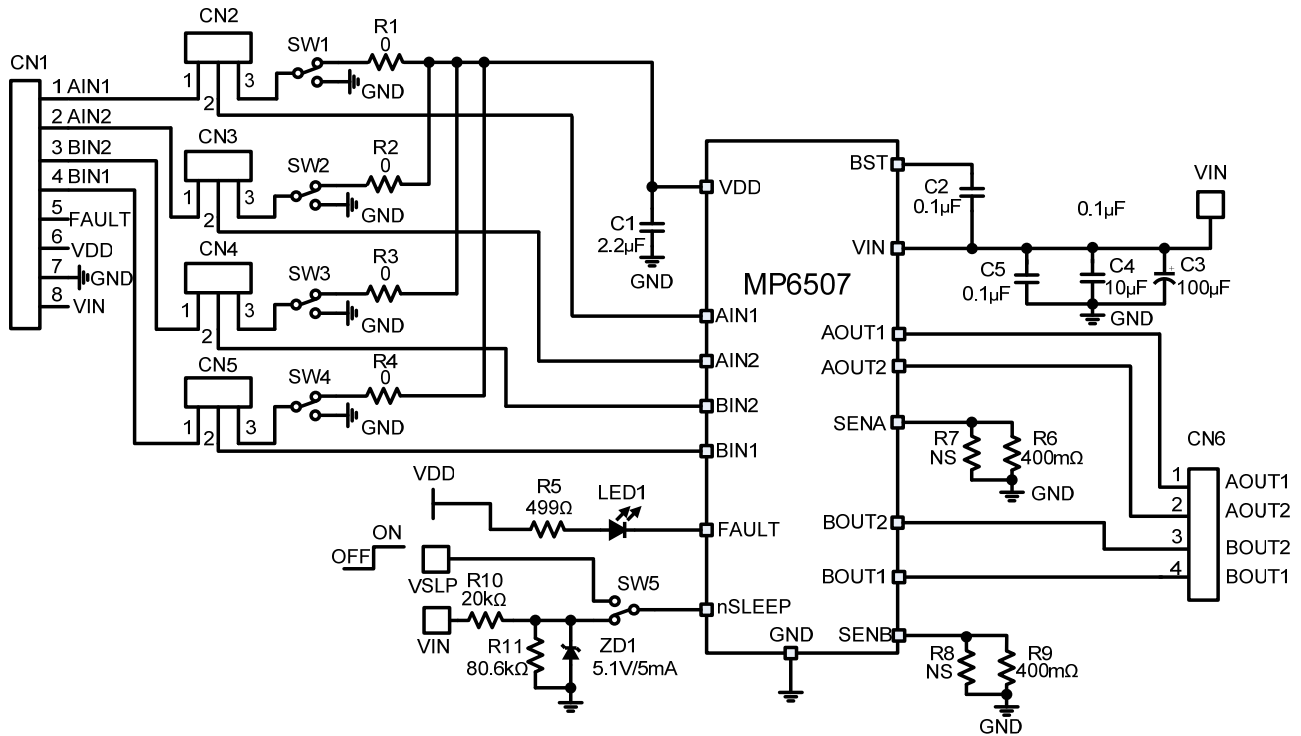

EV6507GQ-00A BILL OF MATERIALS

Qty	Ref	Value	Description	Package	Manufacturer	Part Number
1	C1	2.2 μ F	Ceramic Capacitor, 10V, X7R	0603	Murata	GRM188R71A225KE15D
2	C2,C5	0.1 μ F	Ceramic Capacitor, 25V, X7R	0603	Murata	GRM188R71E104KA01D
1	C3	100 μ F	Electrolytic Capacitor, 50V, X5R	DIP	Jianghai	CD287-50V100
1	C4	10 μ F	Ceramic Capacitor. 50V, X7R	1206	Murata	GRM32ER71H106KA12L
4	R1,R2 R3,R4	0 Ω	Film Resistor, 5%	0603	Royalohm	0603J0000T5E
1	R5	499 Ω	Film Resistor, 1%	0603	Yageo	RC0603FR-07499RL
2	R6,R9	400m Ω	Film Resistor, 1%	1206	Yageo	RL1206FR-070R4L
2	R7,R8	NS	Not Stuffed			
1	R10	20k Ω	Film Resistor, 1%	0603	Yageo	RC0603FR-0720KL
1	R11	80.6k Ω	Film Resistor, 1%	0603	Yageo	RC0603FR-0780K6L
1	ZD1		Zener Diode, 5.1V, 5mA, 500mW	SOD-123	Diodes	BZT52C5V1
1	LED1		LED. Red	0805	Bright LED	BL-HUF35A-TRB
5	SW1-SW5		Switch (2 Bit)			SS-12D01EG4
1	CN1		8PIN, 2.54mm			
4	CN2-CN5		3PIN, 2.54mm (with Short Jumper)			
1	CN6		4PIN, 2.54mm			
1	U1		Stepper Motor Driver	QFN16	MPS	MP6507GQ

EVB TEST RESULTS

Performance waveforms are tested on the evaluation board.

$I_{OUT}=500mA$, $F_{step}=100Hz$, Stepper Motor: $L=2mH$, $R=10\Omega$, $T_A=25^\circ C$, unless otherwise noted.

Steady State-Full Step
 $V_{IN}=15V$

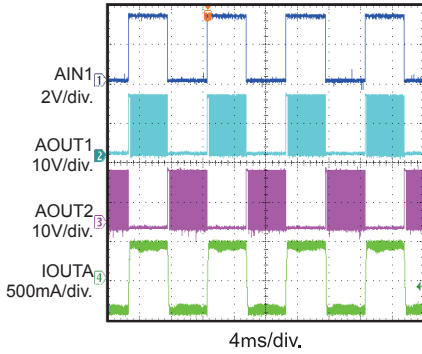

Steady State-Half Step
 $V_{IN}=15V$

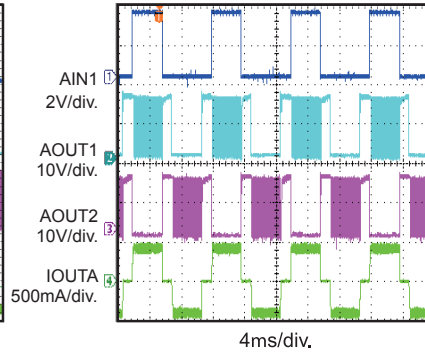

Power Ramp Up-Full Step
 $V_{IN}=15V$

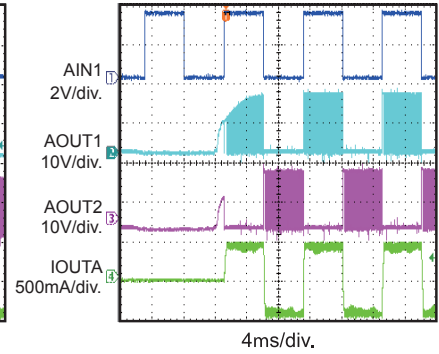

Power Ramp Up-Half Step
 $V_{IN}=15V$

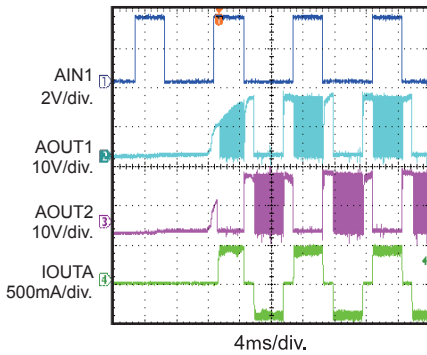

Sleep Entry-Full Step
 $V_{IN}=9V$

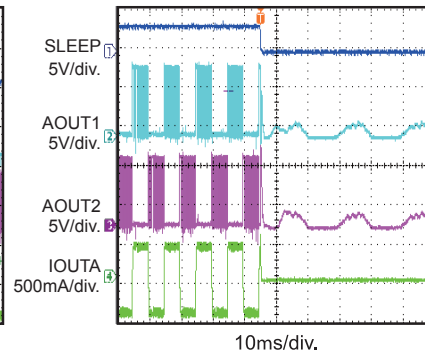

Sleep Recovery-Full Step
 $V_{IN}=9V$

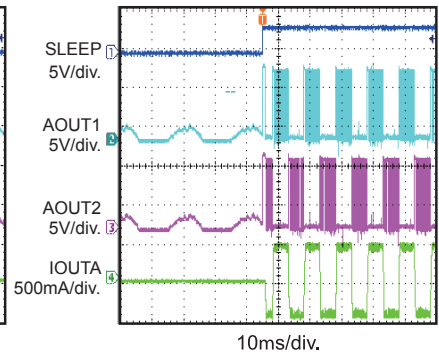

Sleep Entry-Half Step
 $V_{IN}=9V$

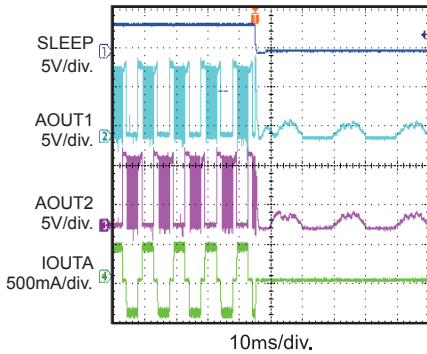

Sleep Recovery-Half Step
 $V_{IN}=9V$

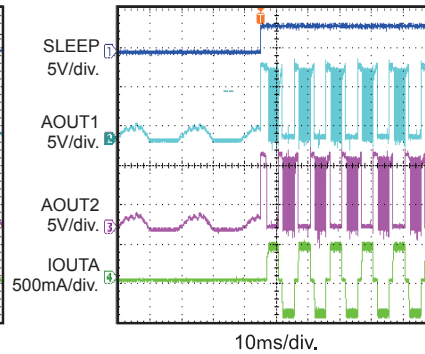

PRINTED CIRCUIT BOARD LAYOUT

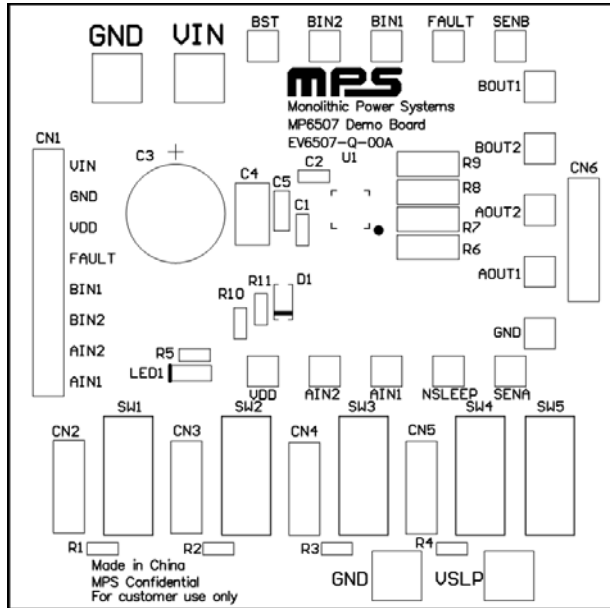

Figure 1—Top Silk Layer

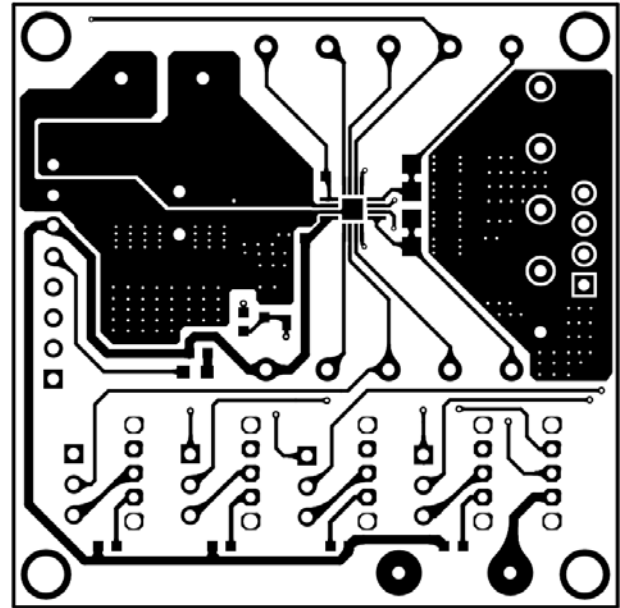

Figure 2—Top Layer

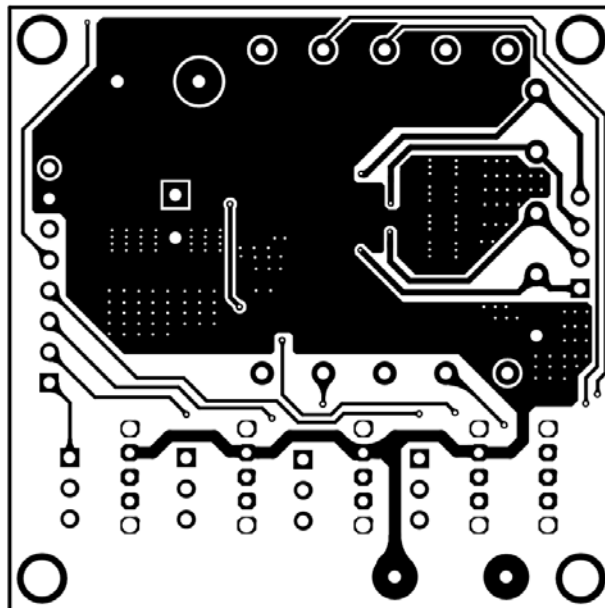

Figure 3—Bottom Layer

QUICK START GUIDE

1. The power and control signals for the MP6507GQ are applied through the connector CN1. Each pin in the connector is labeled on the EVB. The control signals of AIN1, AIN2, BIN1 and BIN2 can be generated on board too. Refer the jumpers section (item5) for detailed information. The connector CN1 also outputs the FAULT signal and VDD (5V) from the IC.
2. Preset power supply of 2.7V to 15V between VIN and GND pins on CN1 or external VIN and GND terminals.
3. The connector CN6 should be connected to the motor winding terminals. Each pin in the connector is labeled on the EVB as AOUT1, AOUT2, BOUT1 and BOUT2. The polarity of these connections will affect the direction of the motor in the case of a DC motor. As for a stepper motor, one winding should be connected to AOUT1 and AOUT2, while the other should be connected to BOUT1 and BOUT2.
4. If the SW5 is switched to the VIN position, SLEEP pin will be pulled up to the VIN by a voltage divider resistor. This ensures the part doesn't enter the SLEEP mode. If the SLEEP mode is controlled externally through any controller, then switches the SW5 to VSLP position and connects the SLEEP control signal from the external controller directly to the VSLP terminal.
5. Jumpers CN2, CN3, CN4 and CN5 are used to select the source of the control signals AIN1, AIN2, BIN2 and BIN1 respectively.

By placing a shunt between positions 1-2, the source of the control signals are routed to the connector CN1. This connection allows the user to control these signals through an external controller.

If the shunt is placed between position 2-3, then the source of the control signals are routed to the switches SW1, SW2, SW3 and SW4. These switches can be used to control the state of these input control signals. The state of the motor outputs for various input combinations can be inferred from the MP6507 datasheet.

6. The diode LED1 indicates the status of the FAULT pin. When over-temperature protection happens, FAULT pin is pulled down to a low level and this LED lights up.
7. R6, R7, and R8, R9 are the current sense resistors directly connected to SENA and SENB respectively. The other sides of these resistors are connected to GND. These resistors control the current through the MP6507 to be 500mA per channel. To change this value of output current, the resistor value must be changed according to the following formula:

$$I_{LIMIT-A} = \frac{185mV}{R6//R7} \quad I_{LIMIT-B} = \frac{185mV}{R8//R9}$$

NOTICE: The information in this document is subject to change without notice. Please contact MPS for current specifications. Users should warrant and guarantee that third party Intellectual Property rights are not infringed upon when integrating MPS products into any application. MPS will not assume any legal responsibility for any said applications.