

# HIGH CURRENT POWER INDUCTORS

## SSL0705M SERIES

### 1. PART NO. EXPRESSION :

SSL0705M-R10MF-R32

(a) (b) (c) (d) (e)(f) (g)

(a) Series code

(b) Dimension code

(c) Material code

(d) Inductance code

(e) Tolerance code : M =  $\pm 20\%$

(f) F : RoHS Compliant

(g) DCR code

### 2. CONFIGURATION & DIMENSIONS :

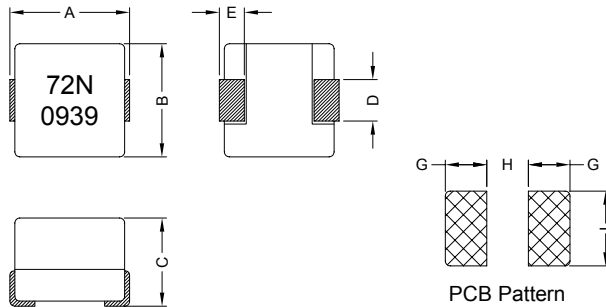

Unit:m/m

A	B	C	D	E	G	H	I
7.0 Max.	7.0 Max.	4.96 Max.	2.49 $\pm$ 0.25	1.52 $\pm$ 0.25	2.03 $\pm$ 0.25	3.3 $\pm$ 0.25	3.05 $\pm$ 0.25

### 3. SCHEMATIC :

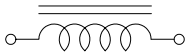

### 4. GENERAL SPECIFICATION :

- Operating temp. : -40° C to +125° C
- I<sub>rms</sub> (A) : Will cause coil temp. to rise approximately  $\Delta T=40^{\circ}C$  without core loss.
- I<sub>sat</sub> (A) : Will cause L<sub>0</sub> to drop approximately 20%
- Part temperature (ambient + temp. rise) : Should not exceed 125° C under worst case operating conditions.

### 5. ELECTRICAL CHARACTERISTICS :

Part No.	Inductance L <sub>0</sub> ( uH )	Test Freq. ( Hz )	DCR ( mΩ ) ± 9.4%	I <sub>rms</sub> ( A ) Max.	I <sub>sat</sub> ( A ) Max.
SSL0705M-72NMF-R32	0.072 $\pm$ 20%	0.25V/1M	0.32	31	58
SSL0705M-R10MF-R32	0.105 $\pm$ 20%	0.25V/1M	0.32	31	46
SSL0705M-R15MF-R32	0.150 $\pm$ 20%	0.25V/1M	0.32	24	30
SSL0705M-72NMF-R46	0.072 $\pm$ 20%	0.25V/1M	0.46	31	58
SSL0705M-R10MF-R46	0.105 $\pm$ 20%	0.25V/1M	0.46	31	46
SSL0705M-R15MF-R46	0.150 $\pm$ 20%	0.25V/1M	0.46	24	30



RoHS Compliant

NOTE : Specifications subject to change without notice. Please check our website for latest information.

08.04.2011



SUPERWORLD ELECTRONICS (S) PTE LTD

## 6. CHARACTERISTICS CURVES :

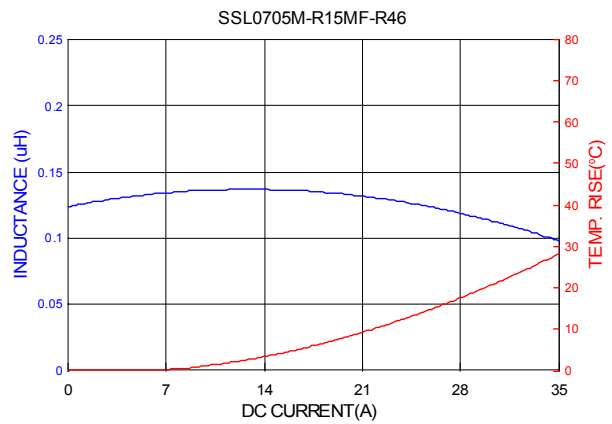
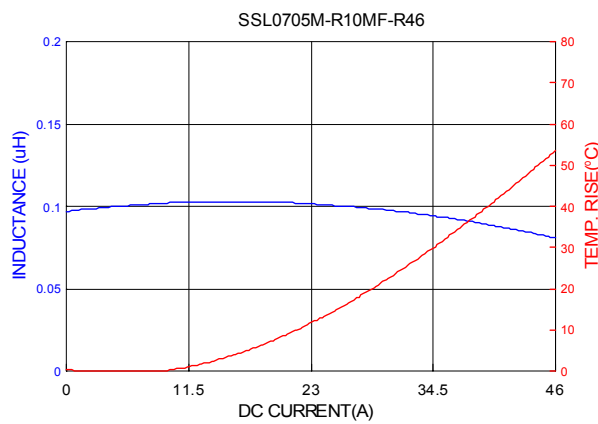
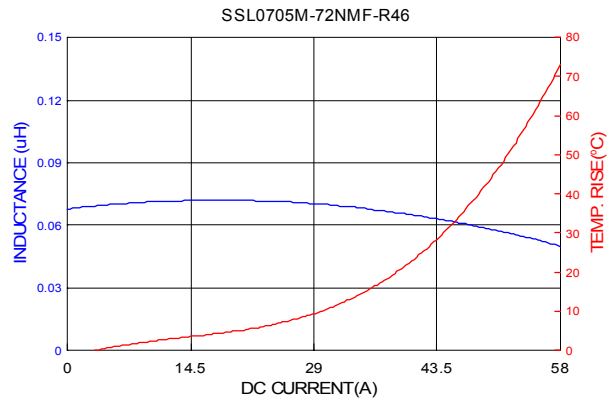
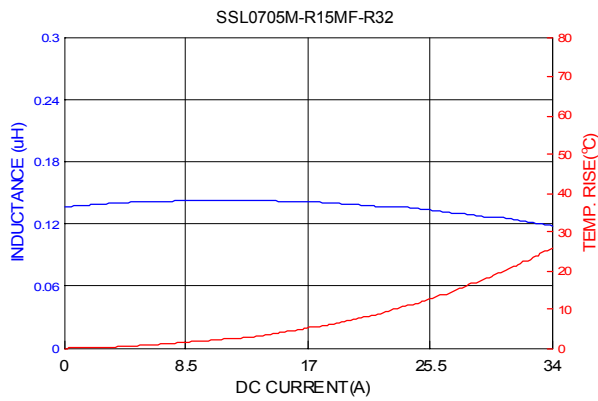
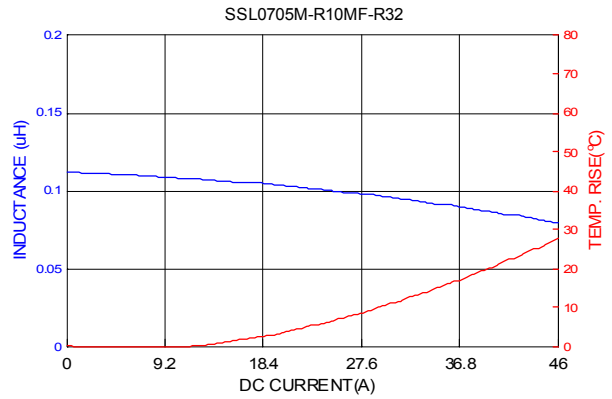
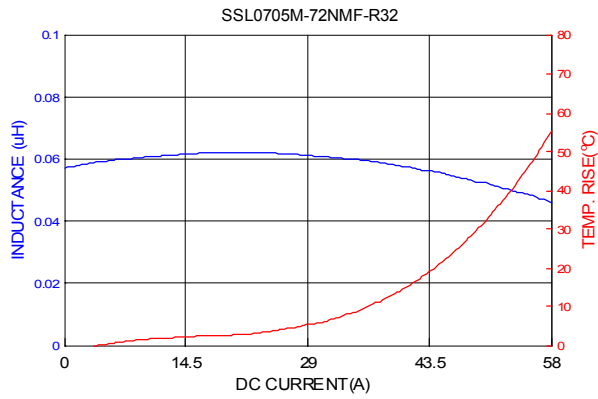

**RoHS Compliant**

NOTE : Specifications subject to change without notice. Please check our website for latest information.

08.04.2011



**SUPERWORLD ELECTRONICS (S) PTE LTD**

## 7. RELIABILITY AND TEST CONDITION :

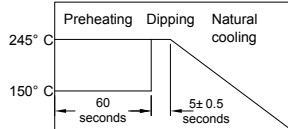
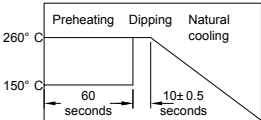
ITEM	PERFORMANCE	TEST CONDITION														
Electrical Characteristics Test																
Inductance	Refer to standard electrical characteristics list	HP4284A														
DCR		HIOKI3540														
Heat Rated Current (Irms)		Irms(A) will cause the coil temperature rise approximately $\Delta T=40^{\circ}\text{C}$ without core loss														
Saturation Current (Isat)		Isat(A) will cause $L_0$ to drop approximately 20%														
Mechanical Performance Test																
Solderability Test	More than 90% of the terminal electrode should be covered with solder.	 <p>After fluxing, component shall be dipped in a melted solder bath at <math>245\pm 5^{\circ}\text{C}</math> for 5 secs</p>														
Solder Heat Resistance	1. Appearance : No significant abnormality 2. Inductance change : Within $\pm 20\%$ of initial value	Preheat : $150^{\circ}\text{C}$ , 60sec. Solder : Sn-Ag3.0-Cu0.5 Solder Temperature : $260\pm 5^{\circ}\text{C}$ Flux : rosin Dip Time : $10\pm 0.5\text{sec}$ . 														
Reliability Test																
High Temperature Life Test	1. Appearance : No damage 2. Inductance : Within $\pm 20\%$ of initial value. No disconnection or short circuit.	Temperature : $125\pm 5^{\circ}\text{C}$ Time : $500\pm 12$ hours Recovery : 4 to 24hrs of recovery under the standard condition after the removal from test chamber.														
Low Temperature Life Test		Temperature : $-40\pm 5^{\circ}\text{C}$ Time : $500\pm 12$ hours Recovery : 4 to 24hrs of recovery under the standard condition after the removal from test chamber.														
Thermal Shock		Conditions of 1 cycle. <table border="1" data-bbox="922 1346 1286 1478"> <thead> <tr> <th>Step</th> <th>Temperature (<math>^{\circ}\text{C}</math>)</th> <th>Times (min.)</th> </tr> </thead> <tbody> <tr> <td>1</td> <td><math>-25\pm 3</math></td> <td><math>30\pm 3</math></td> </tr> <tr> <td>2</td> <td>Room Temperature</td> <td>Within 3</td> </tr> <tr> <td>3</td> <td><math>85\pm 3</math></td> <td><math>30\pm 3</math></td> </tr> <tr> <td>4</td> <td>Room Temperature</td> <td>Within 3</td> </tr> </tbody> </table> Total : 5 cycles Recovery : 4 to 24hrs of recovery under the standard condition after the removal from test chamber.	Step	Temperature ( $^{\circ}\text{C}$ )	Times (min.)	1	$-25\pm 3$	$30\pm 3$	2	Room Temperature	Within 3	3	$85\pm 3$	$30\pm 3$	4	Room Temperature
Step	Temperature ( $^{\circ}\text{C}$ )	Times (min.)														
1	$-25\pm 3$	$30\pm 3$														
2	Room Temperature	Within 3														
3	$85\pm 3$	$30\pm 3$														
4	Room Temperature	Within 3														
Humidity Resistance	1. Appearance : No damage 2. Inductance : Within $\pm 20\%$ of initial value. No disconnection or short circuit.	Temperature : $40\pm 5^{\circ}\text{C}$ Humidity : 90% to 95% Applied Current : Rated Current Time : $500\pm 12$ hours Recovery : 4 to 24hrs of recovery under the standard condition after the removal from test chamber.														
Random Vibration Test	Appearance : Cracking, chipping and any other defects harmful to the characteristics should not be allowed.	Frequency : 10-55-10Hz for 1 min. Amplitude : 1.52mm Directions and times : X, Y, Z directions for 2 hours. A period of 2 hours in each of 3 mutually perpendicular directions (Total 6 hours).														

NOTE : Specifications subject to change without notice. Please check our website for latest information.

08.04.2011



## 8. SOLDERING AND MOUNTING :

### 8-1. Recommended PC Board Pattern

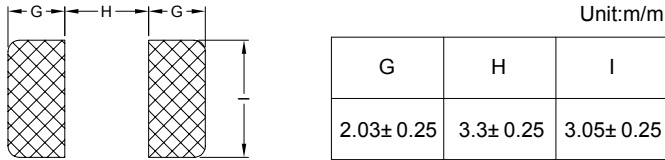

### 8-2. Soldering

Mildly activated rosin fluxes are preferred. The minimum amount of solder can lead to damage from the stresses caused by the difference in coefficients of expansion between solder, chip and substrate. Our terminations are suitable for all wave and re-flow soldering systems. If hand soldering cannot be avoided, the preferred technique is the utilization of hot air soldering tools.

#### 8-2.1 Solder Re-flow :

Recommended temperature profiles for re-flow soldering in Figure 1.

#### 8-2.2 Soldering Iron (Figure 2) :

Products attachment with soldering iron is discouraged due to the inherent process control limitations. In the event that a soldering iron must be employed the following precautions are recommended.

Note :

- a) Preheat circuit and products to 150° C.
- b) 280° C tip temperature (max)
- c) Never contact the ceramic with the iron tip
- d) 1.0mm tip diameter (max)
- e) Use a 20 watt soldering iron with tip diameter of 1.0mm
- f) Limit soldering time to 3 secs.

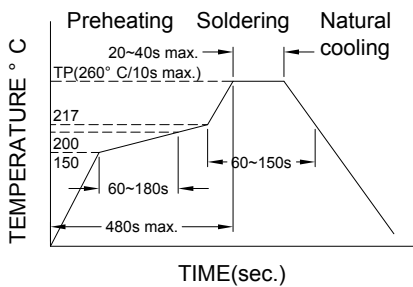

Figure 1. Re-flow Soldering

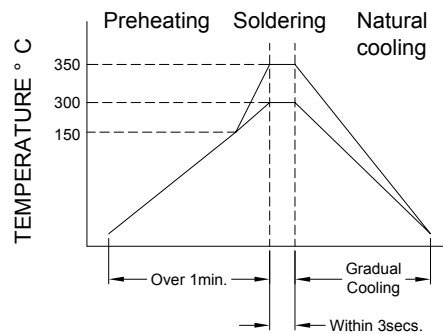

Figure 2. Iron Soldering



**RoHS Compliant**

NOTE : Specifications subject to change without notice. Please check our website for latest information.

08.04.2011



**SUPERWORLD ELECTRONICS (S) PTE LTD**

## 9. PACKAGING INFORMATION :

### 9-1. Reel Dimension

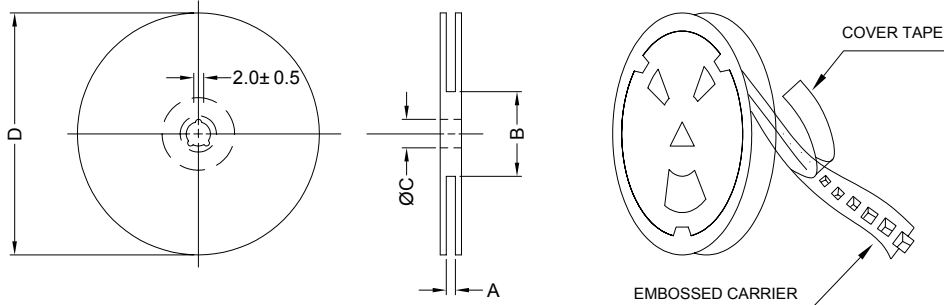

Type	A(mm)	B(mm)	C(mm)	D(mm)
13" x 16mm	16.0±0.5	75±2	13.5±0.5	330

### 9-2 Tape Dimension

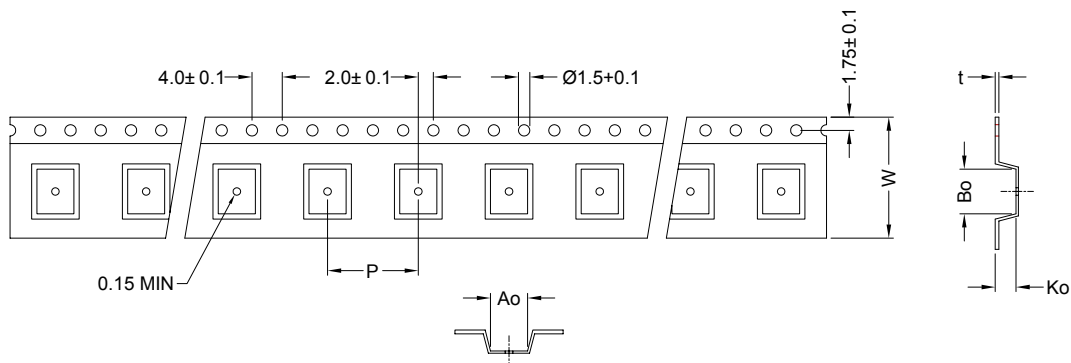

Series	Ao(mm)	Bo(mm)	Ko(mm)	P(mm)	W(mm)	t(mm)
SSL0705M	7.2±0.1	7.4±0.1	5.2±0.1	12.0±0.1	16.0±0.3	0.35±0.05

### 9-3 Packaging Quantity

Size	SSL0705M
Chip / Reel	1000
Inner Box	2000
Carton	8000



**RoHS Compliant**

NOTE : Specifications subject to change without notice. Please check our website for latest information.

08.04.2011



**SUPERWORLD ELECTRONICS (S) PTE LTD**

### 9-4. Tearing Off Force

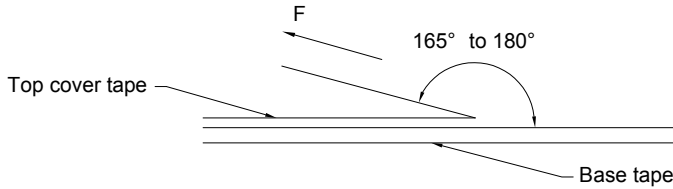

The force for tearing off cover tape is 10 to 130 grams in the arrow direction under the following conditions. (referenced ANSI/EIA-481-C-2003 of 4.11 standard)

Room Temp. (° C)	Room Humidity (%)	Room atm (hPa)	Tearing Speed (mm/min)
5~35	45~85	860~1060	300

### Application Notice

#### 1. Storage Conditions :

To maintain the solderability of terminal electrodes :

- a) Temperature and humidity conditions : Less than 40° C and 70% RH.
- b) Recommended products should be used within 6 months from the time of delivery.
- c) The packaging material should be kept where no chlorine or sulfur exists in the air.

#### 2. Transportation :

- a) Products should be handled with care to avoid damage or contamination from perspiration and skin oils.
- b) The use of tweezers or vacuum pick up is strongly recommended for individual components.
- c) Bulk handling should ensure that abrasion and mechanical shock are minimized.



**RoHS Compliant**

NOTE : Specifications subject to change without notice. Please check our website for latest information.

08.04.2011



**SUPERWORLD ELECTRONICS (S) PTE LTD**