



HEIDENHAIN



Product Information

ECN 1313

ECN 1325

ERN 1387

Rotary Encoders with
Plane-Surface Coupling for
Elevator Servo Drive
Control

July 2017

ECN/ERN 1300 series

Rotary encoders with integral bearings for elevator technology

- Simple installation
- Rigid shaft coupling
- Plane-surface coupling for large mounting tolerances
- Uniform dimensions for various electrical interfaces

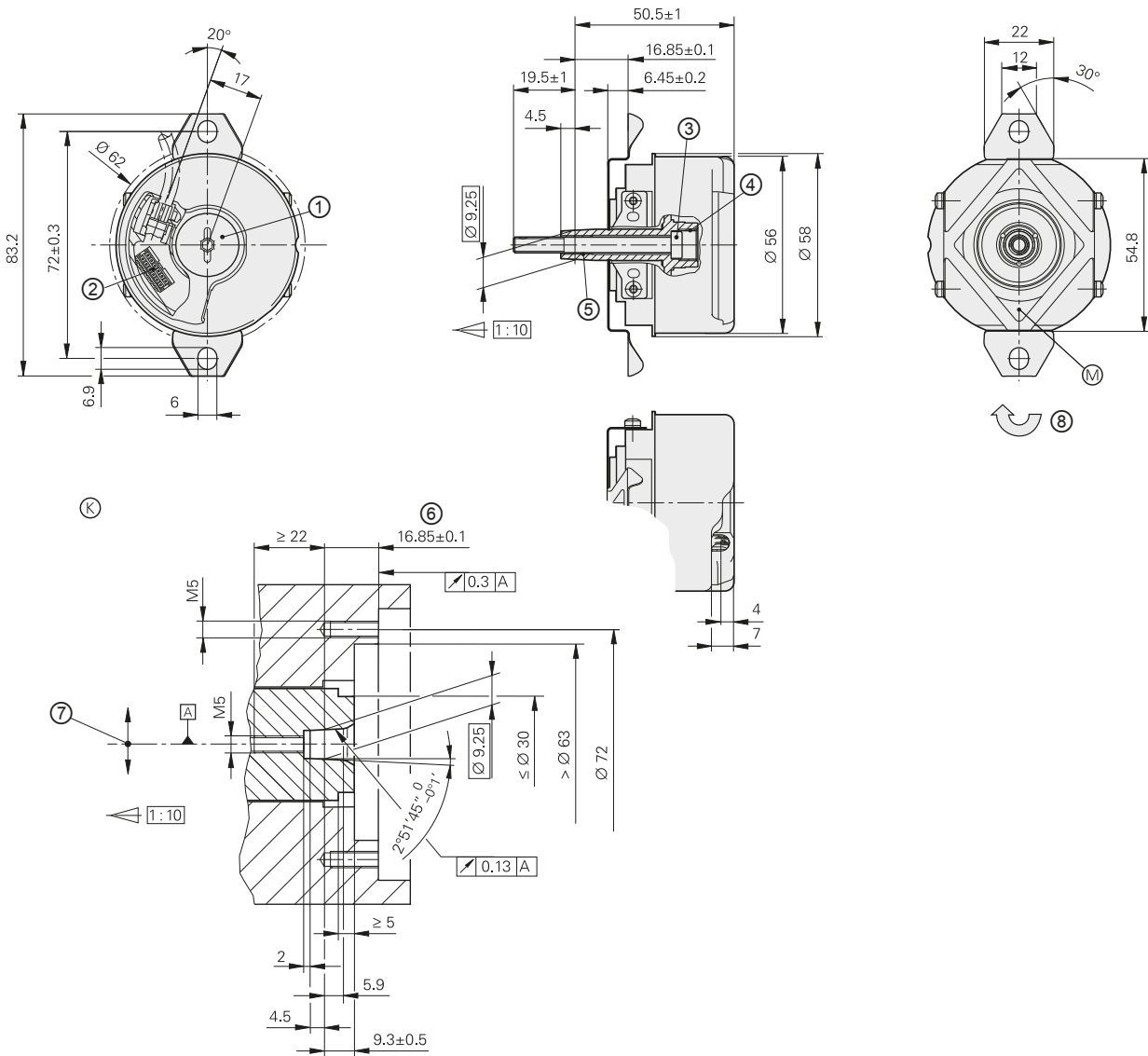

mm

 Tolerancing ISO 8015
 ISO 2768 - m H
 < 6 mm: ±0.2 mm

- ▣ = Bearing of mating shaft
- ▣ = Bearing of encoder
- ⊙ = Required mating dimensions
- ⊙ = Measuring point for operating temperature
- 1 = Screw plug, width A/F 3 and 4. Tightening torque: 5+0.5 Nm
- 2 = PCB connector
- 3 = Self-tightening screw M5 x 50 DIN 6912 width A/F 4, tightening torque 5+0.5 Nm
- 4 = M10 back-off thread
- 5 = M6 back-off thread
- 6 = Max. permissible tolerance during motor shaft rotation ±1.5 mm
- 7 = Max. permissible static radial offset of motor shaft in indicated direction ±0.13 mm
- 8 = Direction of shaft rotation for output signals as per the interface description

	Absolute		Incremental
	ECN 1325	ECN 1313	ERN 1387
Part number	683643-xx	768295-xx	749146-xx
Interface¹⁾	EnDat 2.2		~ 1 V _{PP}
Ordering designation	EnDat22	EnDat01	–
Position values/revolution	33554432 (25 bits)	8192 (13 bits)	Z1 track ³⁾
Electrically permissible speed/error ²⁾	≤ 15000 rpm (for continuous position value)	≤ 1500 rpm/±1 LSB ≤ 12000 rpm/±50 LSB	–
Calculation time t _{cal} Clock frequency	≤ 7 μs ≤ 16 MHz	≤ 9 μs ≤ 2 MHz	– –
Incremental signals ¹⁾	–	~ 1 V _{PP}	~ 1 V _{PP}
Line count/system accuracy	2048/±20"		
Reference mark	–		One
Cutoff frequency –3 dB	–	≥ 400 kHz	≥ 210 kHz
Electrical connection Via PCB connector	<i>Rotary encoder</i> : 12-pin <i>Temperature sensor⁴⁾</i> : 4-pin	12-pin	14-pin
Voltage supply	DC 3.6 V to 14 V		DC 5 V ±0.25 V
Power consumption ¹⁾ (maximum)	3.6 V: ≤ 600 mW 14 V: ≤ 700 mW		–
Current consumption	5 V: 85 mA (typical, without load)		≤ 130 mA (without load)
Stator coupling	Plane-surface coupling		
Shaft	Taper shaft Ø 9.25 mm; taper 1:10		
Mech. permiss. speed n	≤ 2000 rpm		
Starting torque	≤ 0.01 Nm (at 20 °C)		
Moment of inertia of rotor	2.6 · 10 ⁻⁶ kgm ²		
Permissible axial motion of measured shaft ⁵⁾	±1.5 mm		
Radial runout of the measured shaft	0.13 mm		
Vibration 55 Hz to 2000 Hz Shock 6 ms	≤ 300 m/s ² ⁶⁾ (EN 60068-2-6) ≤ 2000 m/s ² (EN 60068-2-27)		
Operating temperature	–40 °C to +115 °C		–40 °C to +120 °C
Protection EN 60529	IP40 when mounted		
Mass	≈ 0.25 kg		

¹⁾ See *Interfaces of HEIDENHAIN Encoders* brochure

²⁾ Velocity-dependent deviations between the absolute value and incremental signals

³⁾ One sine and one cosine signal per revolution

⁴⁾ Evaluation optimized for KTY 84-130

⁵⁾ Compensation of mounting tolerances and thermal expansion, not dynamic motion

⁶⁾ As per standard for room temperature; for operating temperature

Up to +100 °C: ≤ 300 m/s²

Up to +115 °C or +120 °C: ≤ 150 m/s²

Electrical connection

Pin layouts

ECN 1313 pin layout

17-pin coupling or flange socket M23						12-pin PCB connector								
	Power supply					Incremental signals ¹⁾				Serial data transfer				
	7	1	10	4	11	15	16	12	13	14	17	8	9	
	12	1b	6a	4b	3a	/	2a	5b	4a	3b	6b	1a	2b	5a
	U_P	Sensor U _P	0V	Sensor 0V	Internal shield	A+	A-	B+	B-	DATA	DATA	CLOCK	CLOCK	
	Brown/ Green	Blue	White/ Green	White	/	Green/ Black	Yellow/ Black	Blue/ Black	Red/ Black	Gray	Pink	Violet	Yellow	

Other signals		
	5	6
	/	/
	/	/
	Brown ²⁾	White ²⁾

Cable shield connected to housing; **U_P** = Power supply voltage; **T** = Temperature
Sensor: The sensor line is connected in the encoder with the corresponding power line.
 Vacant pins or wires must not be used.





- ¹⁾ Only with ordering designations EnDat 01 and EnDat 02
²⁾ Only for cables inside the motor housing

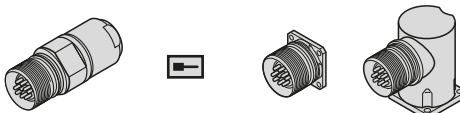
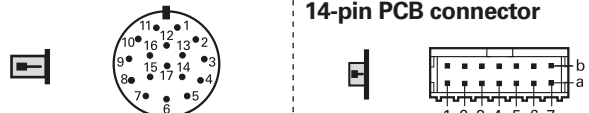

ECN 1325 pin layout

8-pin coupling or flange socket, M12					9-pin flange socket, M23					
16-pin PCB connector										
	Voltage supply				Serial data transfer				Other signals	
	8	2	5	1	3	4	7	6	/	/
	3	7	4	8	5	6	1	2	/	/
	1b	6a	4b	3a	6b	1a	2b	5a	8a	8b
	U_P	Sensor U _P	0V	Sensor 0V	DATA	DATA	CLOCK	CLOCK	T+	T-
	Brown/ Green	Blue	White/ Green	White	Gray	Pink	Violet	Yellow	Brown	Green

Cable shield connected to housing
U_P = Power supply; **T** = Temperature
Sensor: The sensor line is connected in the encoder with the corresponding power line.
 Vacant pins or wires must not be used.

ERN 1387 pin layout

17-pin coupling or flange socket M23						14-pin PCB connector						
												
	Voltage supply						Incremental signals					
	7	1	10	4	11	15	16	12	13	3	2	
	1b	7a	5b	3a	/	6b	2a	3b	5a	4b	4a	
	U_P	Sensor U _P	0V	Sensor 0V	Internal shield	A+	A-	B+	B-	R+	R-	
	Brown/ Green	Blue	White/ Green	White	/	Green/ Black	Yellow/ Black	Blue/Black	Red/Black	Red	Black	

Other signals						
	14	17	9	8	5	6
	7b	1a	2b	6a	/	/
	C+	C-	D+	D-	T+ ¹⁾	T- ¹⁾
	Gray	Pink	Yellow	Violet	Green	Brown

Cable shield connected to housing;

U_P = Power supply; **T** = Temperature

Sensor: The sensor line is connected internally with the corresponding power line. Vacant pins or wires must not be used.

¹⁾ Only for cables inside the motor housing

HEIDENHAIN measuring equipment

PWM 20

Together with the ATS adjusting and testing software, the PWM 20 phase angle measuring unit serves for diagnosis and adjustment of HEIDENHAIN encoders.



For more information, see the *PWM 20/ATS Software* Product Information document.

	PWM 20
Encoder input	<ul style="list-style-type: none"> • EnDat 2.1 or EnDat 2.2 (absolute value with or without incremental signals) • DRIVE-CLiQ • Fanuc Serial Interface • Mitsubishi high speed interface • Yaskawa Serial Interface • Panasonic serial interface • SSI • 1 V_{PP}/TTL/11 μA_{PP} • HTL (via signal adapter)
Interface	USB 2.0
Voltage supply	AC 100 V to 240 V or DC 24 V
Dimensions	258 mm x 154 mm x 55 mm

	ATS
Languages	Choice between English and German
Functions	<ul style="list-style-type: none"> • Position display • Connection dialog • Diagnostics • Mounting wizard for EBI/ECI/EQI, LIP 200, LIC 4000 and others • Additional functions (if supported by the encoder) • Memory contents
System requirements and recommendations	PC (dual-core processor > 2 GHz) RAM > 2 GB Operating system: Windows XP, Vista, 7, 8, 10 (32-bit/64-bit) 200 MB free space on hard disk

DRIVE-CLiQ is a registered trademark of SIEMENS AG.

PWT 100

The PWT 100 is a testing device for checking the function and adjustment of incremental and absolute HEIDENHAIN encoders. Thanks to its compact dimensions and robust design, the PWT 100 is ideal for mobile use.



You can find more information in the Product Information *PWT 100*.

	PWT 100
Encoder input Only for HEIDENHAIN encoders	<ul style="list-style-type: none"> • EnDat • Fanuc Serial Interface • Mitsubishi High Speed Interface • Panasonic Serial Interface • Yaskawa Serial Interface • 1 V_{PP} • 11 μA_{PP} • TTL
Display	4.3" color flat-panel display (touch screen)
Voltage supply	DC 24 V Power consumption: max. 15 W
Operating temperature	0 °C to 40 °C
Protection EN 60 529	IP20
Dimensions	≈ 145 mm x 85 mm x 35 mm

Test cable for connection to PWM 20/PWT 100

AGK ERN 1387 Ø 4.5 mm PUR (with shield crimping Ø 6 mm); PCB connector (with shield strain relief, 14-pin/D-sub connector (male), 15-pin incl. three 14-pin adapter connectors		2 m	2 x AWG 30/7	1118892-02
AGK ECI 11xx/ECI 13xx/EQI 11xx/EQI 13xx/ExN 11xx/ExN 13xx , Ø 4.5 mm EPG (with Ø 6 mm shield crimping; PCB connector with strain relief, 12-pin/D-sub connector (male), 15-pin incl. 3 adapter connectors, 12-pin and 3 adapter connectors, 15-pin		2 m	2 x AWG 30/7	621742-01

HEIDENHAIN

DR. JOHANNES HEIDENHAIN GmbH

Dr.-Johannes-Heidenhain-Straße 5

83301 Traunreut, Germany

☎ +49 8669 31-0

FAX +49 8669 32-5061

E-mail: info@heidenhain.de

www.heidenhain.de

This Product Information supersedes all previous editions, which thereby become invalid. The basis for ordering from HEIDENHAIN is always the Product Information document edition valid when the order is made.



For more information:

Comply with the requirements described in the following documents to ensure the correct operation of the encoder:

- Brochure: *Position Encoders for Servo Drives*
- Brochure: *Rotary Encoders*
- Brochure: *Interfaces of HEIDENHAIN Encoders*