

APED3820SURC-F01

HYPER RED

### Features

- 3.8mmx2.0mm SMT LED,3.2mm THICKNESS.
- LOW POWER CONSUMPTION.
- IDEAL FOR BACKLIGHT AND INDICATOR.
- VARIOUS COLORS AND LENS TYPES AVAILABLE.
- PACKAGE : 500PCS / REEL.
- RoHS COMPLIANT.

### Description

The Hyper Red source color devices are made with DH InGaAlP on GaAs substrate Light Emitting Diode.

### Package Dimensions

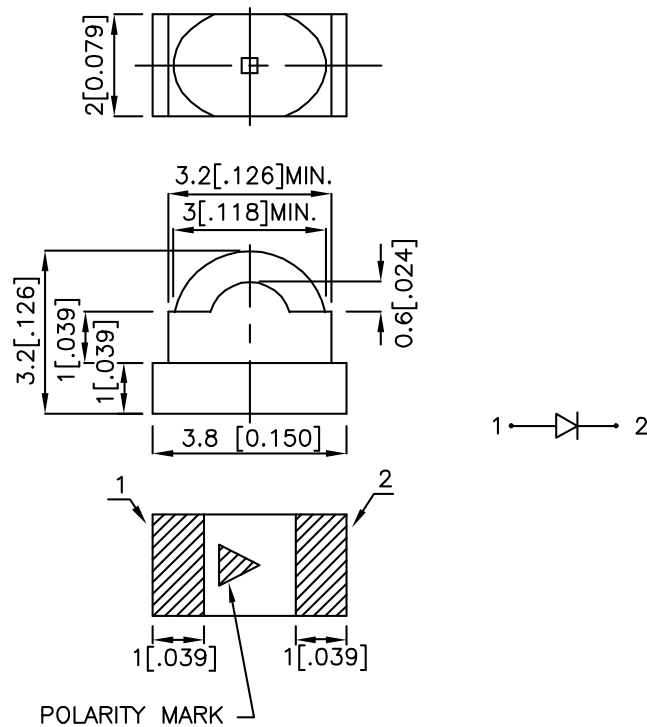

#### Notes:

1. All dimensions are in millimeters (inches).
2. Tolerance is  $\pm 0.2(0.008)$  unless otherwise noted.
3. Specifications are subject to change without notice.

## Selection Guide

Part No.	Dice	Lens Type	Iv (mcd) @ 20mA		Viewing Angle
			Min.	Typ.	2 θ 1/2
APED3820SURC-F01	HYPER RED (InGaAlP)	WATER CLEAR	180	500	60°(H) 35°(V)

Note:

1. θ1/2 is the angle from optical centerline where the luminous intensity is 1/2 the optical centerline value.

## Electrical / Optical Characteristics at TA=25°C

Symbol	Parameter	Device	Typ.	Max.	Units	Test Conditions
$\lambda_{peak}$	Peak Wavelength	Hyper Red	640		nm	IF=20mA
$\lambda_D$	Dominant Wavelength	Hyper Red	628		nm	IF=20mA
$\Delta\lambda_{1/2}$	Spectral Line Half-width	Hyper Red	27		nm	IF=20mA
C	Capacitance	Hyper Red	45		pF	VF=0V;f=1MHz
VF	Forward Voltage	Hyper Red	1.9	2.5	V	IF=20mA
IR	Reverse Current	Hyper Red		10	uA	VR = 5V

## Absolute Maximum Ratings at TA=25°C

Parameter	Hyper Red	Units
Power dissipation	170	mW
DC Forward Current	30	mA
Peak Forward Current [1]	185	mA
Reverse Voltage	5	V
Operating/Storage Temperature	-40°C To +85°C	

Note:

1. 1/10 Duty Cycle, 0.1ms Pulse Width.

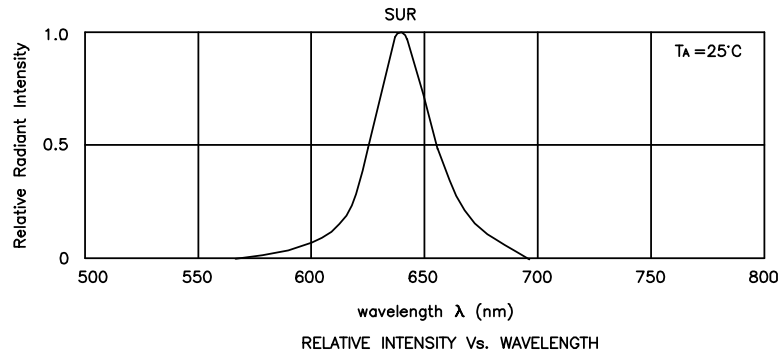

## Hyper Red

### APED3820SURC-F01

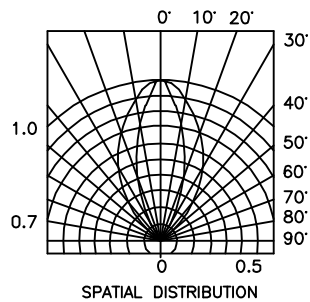
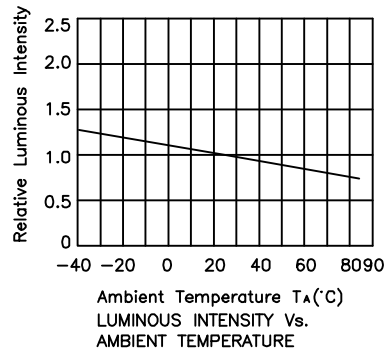
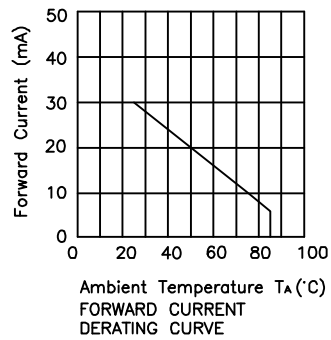
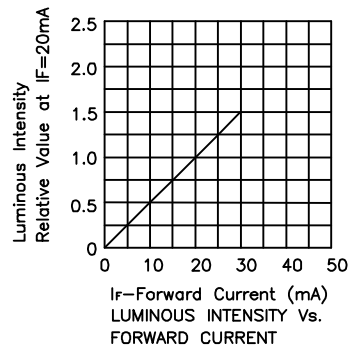
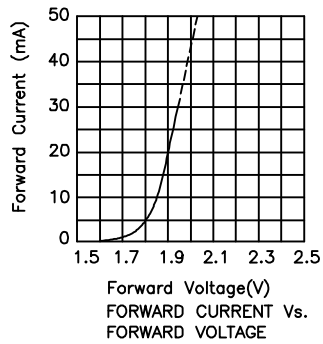

## APED3820SURC-F01

Reflow Soldering Profile For Lead-free SMT Process.

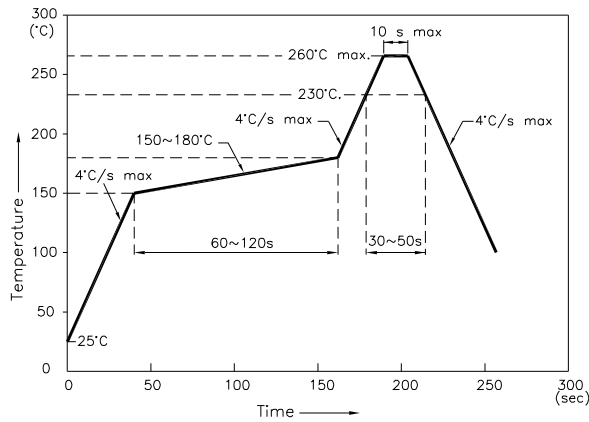

NOTES:

1. We recommend the reflow temperature 245°C (+/-5°C). The maximum soldering temperature should be limited to 260°C.
2. Don't cause stress to the epoxy resin while it is exposed to high temperature.
3. Number of reflow process shall be 2 times or less.

### Recommended Soldering Pattern (Units : mm)

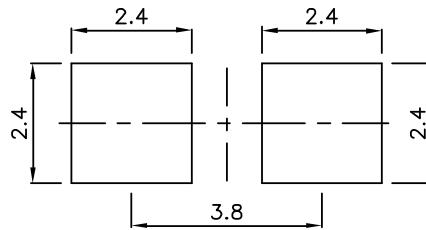

### Tape Specifications (Units : mm)

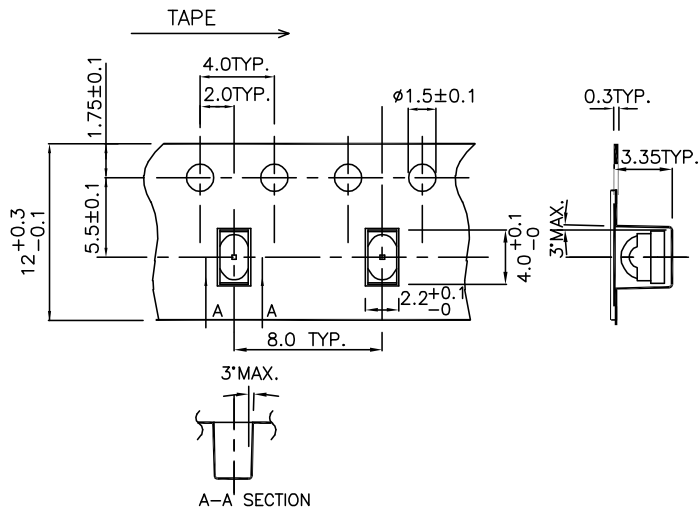

Remarks:

If special sorting is required (e.g. binning based on forward voltage, luminous intensity, or wavelength), the typical accuracy of the sorting process is as follows:

1. Wavelength: +/-1nm
2. Luminous Intensity: +/-15%
3. Forward Voltage: +/-0.1V

Note: Accuracy may depend on the sorting parameters.