



Spec. No.	PS-ND-08090603
Rev.	A

PRODUCT SPECIFICATION

Model No: CSM-57171VM9/57181VM9

Descriptions:

- 1.2 Inch 5X7 Dot-Matrix Display
- Dot Pitch 4.57mm
- CSM-57171: Column Anode, Row Cathode
- CSM-57181: Column Cathode, Row Anode
- Emitting Color: Super Bright Orange & Super Bright Green



CUSTOMER APPROVED SIGNATURES	APPROVED BY	CHECKED BY	PREPARED BY

CHINA SEMICONDUCTOR CORPORATION
Address:2FL. NO.909,Chung-Cheng Road,
Chung-Ho City Taipei Hsien,Taiwan.

Tel:886-2-2223-9696
Fax:886-2-2223-9377

OPTO PLUS TECHNOLOGIES CO.,LTD
Address:696 Shun jiang Rd.,Ji Shan St.Shaoxing,
ZheJiang,China

Tel:86-0575-88623888
Fax:86-0575-88623112



Spec. No.	PS-ND-08090603
Rev.	A

Model No: CSM-57171/57181VM9

■ Features -

1. 1.2 inch (30.3mm) Matrix height.
2. Case mold type.
3. RoHS compliant.
4. Low power consumption.
5. Easy mounting on P.C. board or socket.

■ Device Selection Guide -

Part No.	Chip		Description	
	Material	Emitted Color	Column	Row
CSM-57171VM9	AlGaInP	Super Bright Orange	Anode	Cathode
	AlGaInP	Super Bright Green		
CSM-57181VM9	AlGaInP	Super Bright Orange	Cathode	Anode
	AlGaInP	Super Bright Green		

■ Package Dimensions -

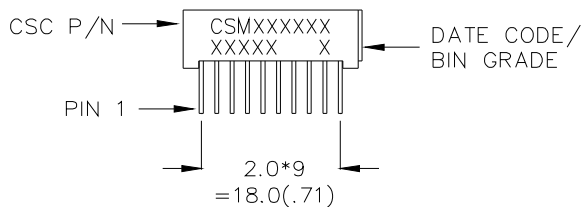
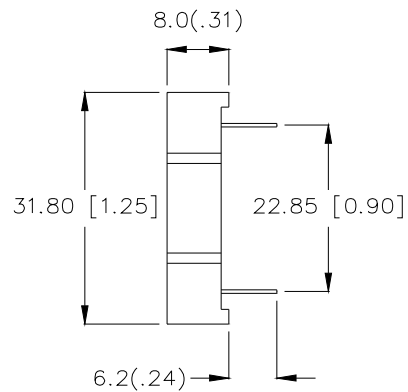
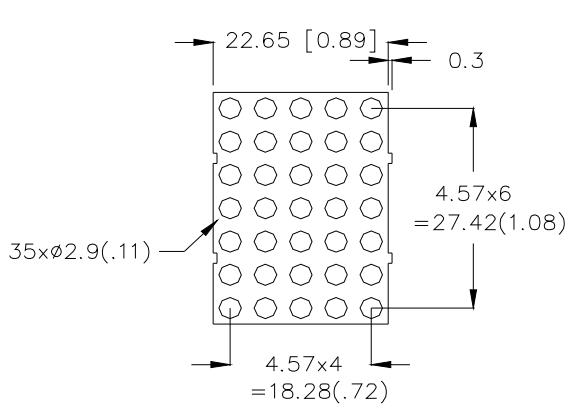

NOTE:

- 1 All pins are $\phi 0.5(.02)$.
- 2 Dimension in millimeters (inch), tolerance is $\pm 0.25 (.01)$ unless otherwise noted.



Model No: CSM-57171/57181VM9

Internal Circuit Diagrams -

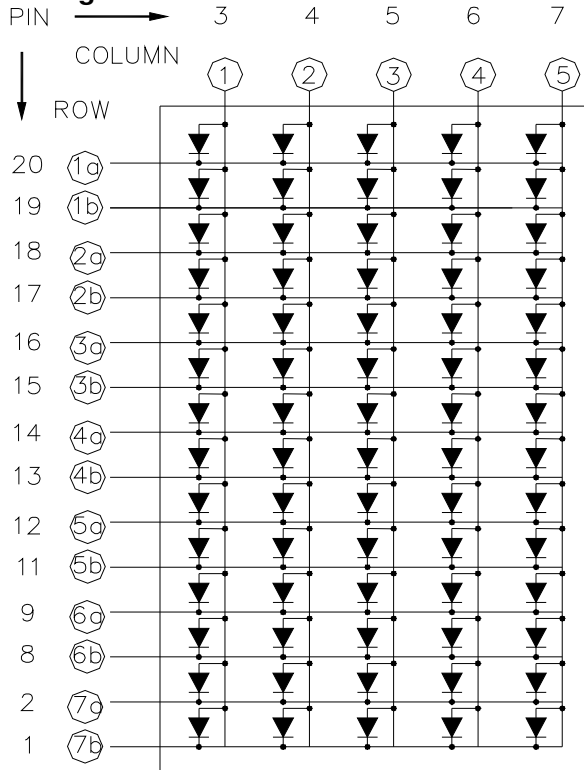

NOTE: "a" Orang color chip

"b" Yellow Green color chip

CSM-57171 Column Anode, Row Cathode.

(CSM-57181 Column Cathode, Row Anode.)

Absolute Maximum Rating -

Super Bright Orange		(Ta=25°C)	
Parameter	Symbol	Rating	Unit
Power Dissipation Per Dice	PAD	70	mW
Continuous Forward Current Per Dice	IAF	25	mA
Peak Current Per Dice(duty cycle 1/10, 1kHz)	IPF	90	mA
Derating Linear From 25°C Per Dice	-	0.33	mA/°C
Reverse Voltage Per Dice	VR	5	V
Operating Temp.	Topr	-35 ~ +85	°C
Storage Temp.	Tstg	-35 ~ +85	°C
Solder temperature 1/16 inch below seating plane for 3 seconds at 260°C			



Model No: CSM-57171/57181VM9

Super Bright Green		(Ta=25°C)	
Parameter	Symbol	Rating	Unit
Power Dissipation Per Dice	P _{AD}	70	mW
Continuous Forward Current Per Dice	I _{AF}	25	mA
Peak Current Per Dice(duty cycle 1/10, 1kHz)	I _{PF}	90	mA
Derating Linear From 25°C Per Dice	-	0.33	mA/°C
Reverse Voltage Per Dice	V _R	5	V
Operating Temp.	T _{opr}	-35 ~ +85	°C
Storage Temp.	T _{stg}	-35 ~ +85	°C
Solder temperature 1/16 inch below seating plane for 3 seconds at 260°C			

■ Electro-optical Characteristics -

Super Bright Orange		(Ta=25°C)				
Parameter	Symbol	Min.	Typ.	Max.	Unit	Condition
Forward Voltage Per Segment	V _F	-	2.0	2.8	V	I _F =20mA
Luminous Intensity Per Segment	I _v	-	25	-	mcd	I _F =10mA
Peak Emission Wavelength	λ _p	-	632	-	nm	I _F =20mA
Dominant Wavelength	λ _d	-	624	-	nm	I _F =20mA
Spectrum Radiation Bandwidth	Δλ	-	20	-	nm	I _F =20mA
Reverse Current	I _R	-	-	100	μA	V _R =5V
Luminous Intensity Matching Ratio	I _{V-m}	-	-	2:1		I _p =80mA 1/16Duty

Super Bright Green		(Ta=25°C)				
Parameter	Symbol	Min.	Typ.	Max.	Unit	Condition
Forward Voltage Per Segment	V _F	-	2.1	2.8	V	I _F =20mA
Luminous Intensity Per Segment	I _v	-	12	-	mcd	I _F =10mA
Peak Emission Wavelength	λ _p	-	572	-	nm	I _F =20mA
Dominant Wavelength	λ _d	-	570	-	nm	I _F =20mA
Spectrum Radiation Bandwidth	Δλ	-	20	-	nm	I _F =20mA
Reverse Current	I _R	-	-	100	μA	V _R =5V
Luminous Intensity Matching Ratio	I _{V-m}	-	-	2:1		I _p =80mA 1/16Duty



Spec. No.	PS-ND-08090603
Rev.	A

Model No: CSM-57171/57181VM9

Typical Electrical / Optical Characteristics Curves -Super Bright Orange

(Ta = 25°C Unless Otherwise Noted)

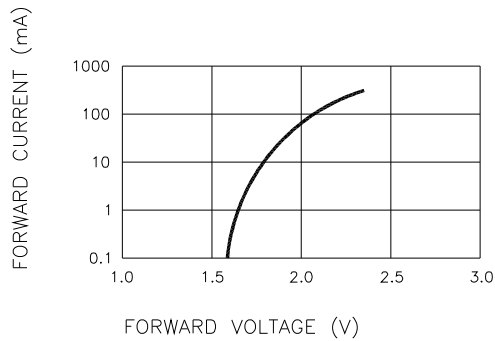

Fig.1 FORWARD CURRENT VS. FORWARD VOLTAGE

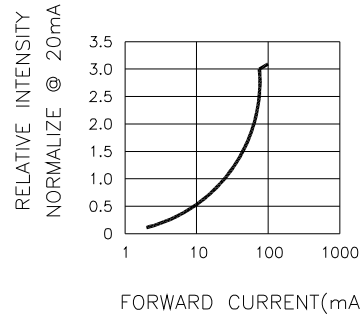

Fig.2 RELATIVE INTENSITY VS. FORWARD CURRENT

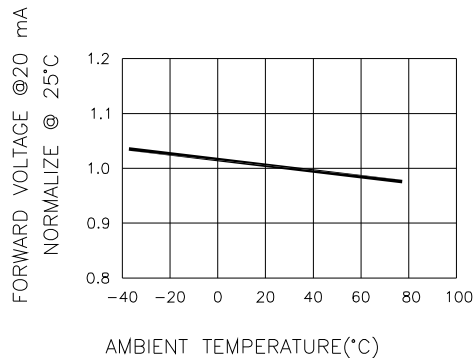

Fig.3 FORWARD VOLTAGE VS. TEMPERATURE

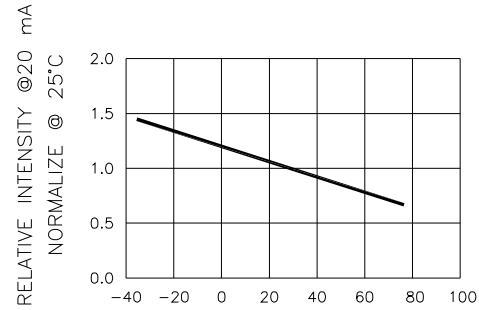

Fig.4 RELATIVE INTENSITY VS. TEMPERATURE

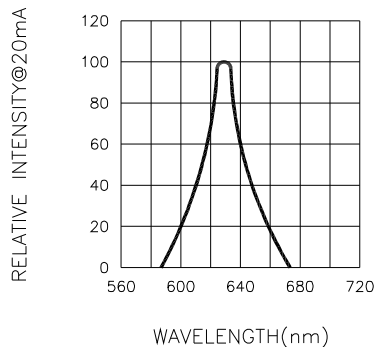

Fig.5 RELATIVE INTENSITY VS. WAVELENGTH



Model No: CSM-57171/57181VM9

■ Super Bright Green

(Ta = 25°C Unless Otherwise Noted)

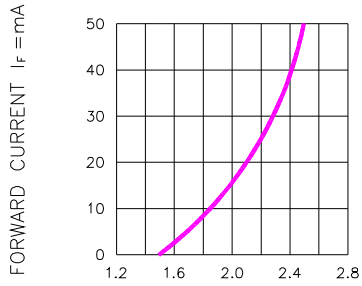

Fig.1 FORWARD CURRENT VS. FORWARD VOLTAGE

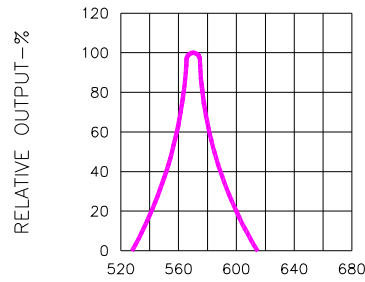

Fig.2 SPECTRAL RESPONSE

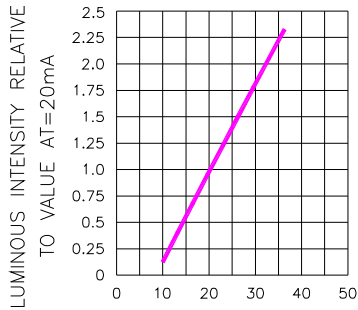

Fig.3 RELATIVE LUMINOUS INTENSITY VS. FORWARD CURRENT

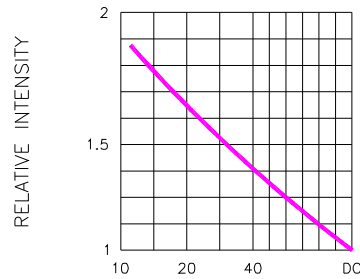

Fig.5 LUMINOUS INTENSITY VS. DUTY CYCLE

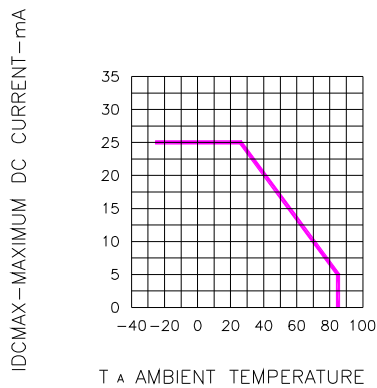

Fig.4 MAXIMUM ALLOWABLE DC CURRENT PER SEGMENT VS. A FUNCTION OF AMBIENT TEMPERATURE

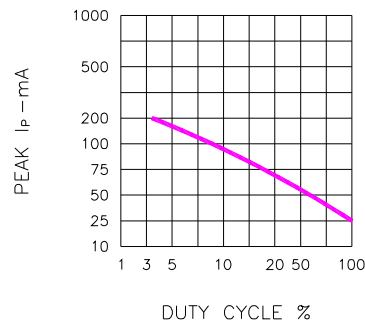

Fig.6 MAX PEAK CURRENT VS. DUTY CYCLE % (REFRESH RATE f=1 KHz)



Spec. No.	PS-ND-08090603
Rev.	A

Model No: CSM-57171/57181VM9

■ Package Dimensions

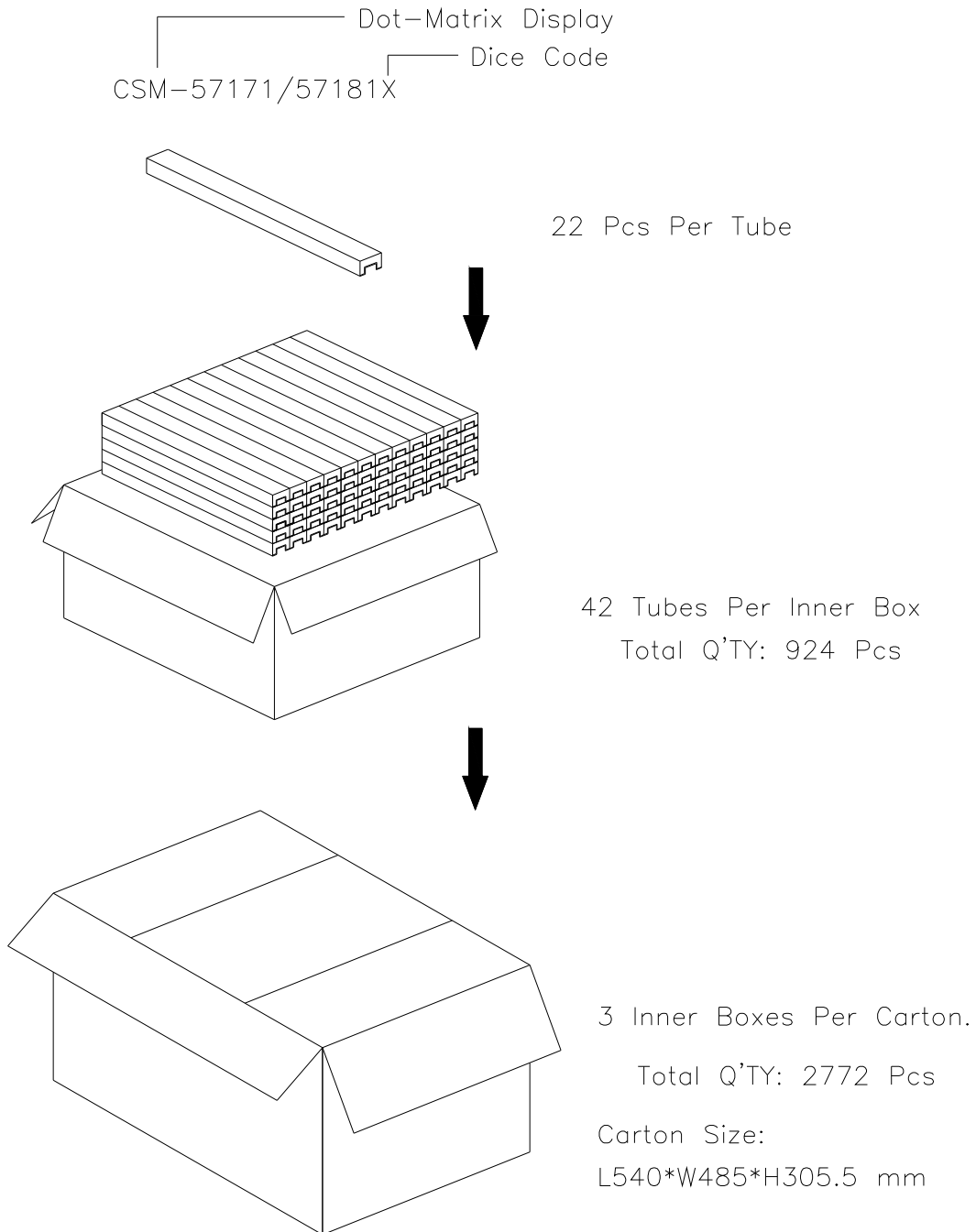

Note: The specifications are subject to change without notice. Please contact us for updated information.