

1. PART NO. EXPRESSION :

C 1 - 1 N 0 S - □□
 (a) (b) (c) (d)

(a) Series code

(b) Inductance code : 1N0 = 1.0nH

(c) Inductance Tolerance : S=±0.3nH , J=±5% , K=±10%

(d) 10: Standard

11 ~ 99 : Internal control number

2. CONFIGURATION & DIMENSIONS :

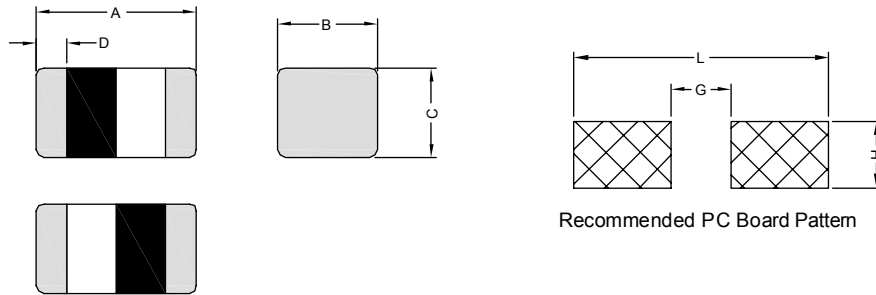

Recommended PC Board Pattern

Unit:m/m

A	B	C	D	G	H	L
1.00±0.05	0.50±0.05	0.50±0.05	0.25±0.10	0.45~0.55	0.45~0.55	1.50

3. SCHEMATIC :

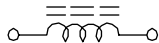

4. MATERIALS :

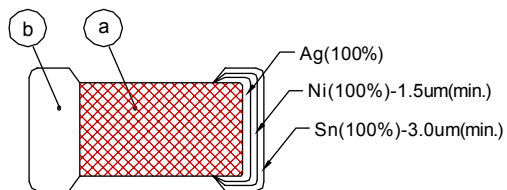

(a) Body : ceramic (Pb Free)

(b) Termination : (Pb Free)

5. GENERAL SPECIFICATION :

- a) Operating temp. : -40° C to +105° C (including self-temperature. rise)
- b) Storage condition (component in its packaging)
 - i) Temperature : -10 to 40° C
 - ii) Humidity : 60%



RoHS Compliant

NOTE : Specifications subject to change without notice. Please check our website for latest information.

26.01.2015



SUPERWORLD ELECTRONICS (S) PTE LTD

6. ELECTRICAL CHARACTERISTICS :

Part Number	Inductance (nH)	Test Frequency (MHz)	Q Min	Q(Typ.) Frequency(MHz)					Rated Current (mA) Max	DC Resistance (Ω)		SRF (MHz)	
				100	300	500	800	1000		Max.	Typ.	Min	Typ.
C1-1N0S-10	1.0	100	8	11	25	34	43	52	300	0.08	0.04	10000	>13000
C1-1N2S-10	1.2	100	8	11	25	35	44	52	300	0.09	0.04	10000	>13000
C1-1N5S-10	1.5	100	8	11	24	33	44	48	300	0.10	0.05	6000	>13000
C1-1N8S-10	1.8	100	8	11	23	30	36	42	300	0.12	0.06	6000	11000
C1-2N0S-10	2.0	100	8	11	21	27	34	39	300	0.12	0.06	6000	10500
C1-2N2S-10	2.2	100	8	10	18	25	31	36	300	0.13	0.07	6000	10000
C1-2N4S-10	2.4	100	8	10	18	24	31	35	300	0.13	0.07	6000	9500
C1-2N7S-10	2.7	100	8	10	18	24	31	34	300	0.13	0.08	6000	9000
C1-3N0S-10	3.0	100	8	10	18	24	31	35	300	0.16	0.09	6000	8500
C1-3N3S-10	3.3	100	8	10	18	24	31	35	300	0.16	0.10	6000	8000
C1-3N6S-10	3.6	100	8	10	18	24	31	35	300	0.20	0.11	5000	7500
C1-3N9S-10	3.9	100	8	10	18	24	31	35	300	0.21	0.12	4000	7000
C1-4N3S-10	4.3	100	8	10	18	24	31	35	300	0.20	0.12	4000	6500
C1-4N7S-10	4.7	100	8	10	18	24	31	34	300	0.21	0.12	4000	6000
C1-5N1S-10	5.1	100	8	10	18	24	31	34	300	0.21	0.13	4000	5800
C1-5N6S-10	5.6	100	8	10	18	24	30	35	300	0.23	0.15	4000	5700
C1-6N2S-10	6.2	100	8	10	18	24	30	34	300	0.25	0.16	3900	5600
C1-6N8□-10	6.8	100	8	10	18	23	29	32	300	0.25	0.17	3900	5500
C1-7N5□-10	7.5	100	8	10	18	23	29	32	300	0.25	0.18	3700	5200
C1-8N2□-10	8.2	100	8	10	18	23	29	31	300	0.28	0.21	3600	4900
C1-9N1□-10	9.1	100	8	10	18	23	29	31	300	0.30	0.22	3400	4500
C1-10N□-10	10	100	8	10	18	23	29	31	300	0.31	0.23	3200	4300
C1-12N□-10	12	100	8	11	18	23	29	31	300	0.40	0.28	2700	3900
C1-15N□-10	15	100	8	11	18	23	28	30	300	0.46	0.31	2300	3500
C1-18N□-10	18	100	8	11	18	23	28	30	300	0.55	0.35	2100	3100
C1-22N□-10	22	100	8	11	17	22	26	27	300	0.60	0.42	1900	2800
C1-27N□-10	27	100	8	11	17	21	25	26	300	0.70	0.47	1600	2300
C1-33N□-10	33	100	8	11	16	20	23	22	200	0.80	0.50	1300	1900
C1-39N□-10	39	100	8	11	16	20	23	21	200	0.90	0.52	1200	1700
C1-47N□-10	47	100	8	11	16	19	21	18	200	1.00	0.58	1000	1500
C1-56N□-10	56	100	8	11	16	18	18	16	200	1.00	0.61	750	1300
C1-68N□-10	68	100	8	11	15	17	18	11	180	1.20	0.70	750	1200
C1-82N□-10	82	100	8	10	14	16	15	6	150	1.30	0.81	600	1100
C1-R10□-10	100	100	8	10	14	14	12	-	150	1.50	0.94	600	1000



RoHS Compliant

NOTE : Specifications subject to change without notice. Please check our website for latest information.

26.01.2015



SUPERWORLD ELECTRONICS (S) PTE LTD

Part Number	Inductance (nH)	Test Frequency (MHz)	Q Min	Q(Typ.) Frequency(MHz)					Rated Current (mA) Max	DC Resistance (Ω)		SRF (MHz)	
				100	300	500	800	1000		Max.	Typ.	Min	Typ.
C1-R12□-10	120	100	8	10	12	10	-	-	150	1.60	1.10	600	800
C1-R15□-10	150	100	8	12	17	17	-	-	140	3.20	2.57	550	920
C1-R18□-10	180	100	8	12	16	-	-	-	130	3.70	2.97	500	810
C1-R22□-10	220	100	8	12	16	-	-	-	120	4.20	3.29	450	700
C1-R27□-10	270	100	8	12	14	-	-	-	110	4.80	3.92	400	600

Inductance Tolerance : □

J=± 5%

K=± 10%

NOTE : Specifications subject to change without notice. Please check our website for latest information.

26.01.2015



7. CHARACTERISTICS CURVES :

Impedance v.s. Frequency Characteristics

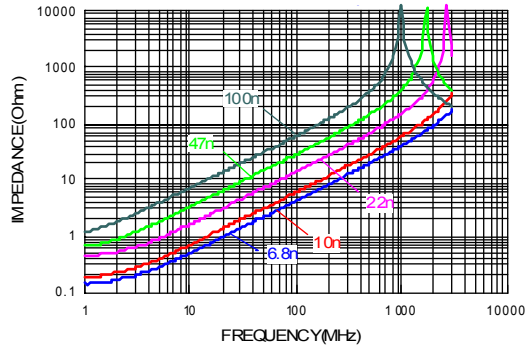

Inductance v.s. Frequency Characteristics

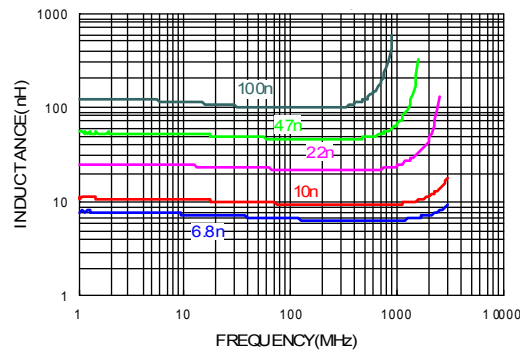

Q v.s. Frequency Characteristics

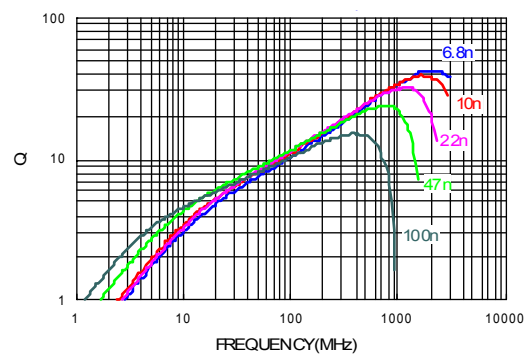

RoHS Compliant

NOTE : Specifications subject to change without notice. Please check our website for latest information.

26.01.2015



8. SOLDERING AND MOUNTING :

8-1. Recommended PC Board Pattern

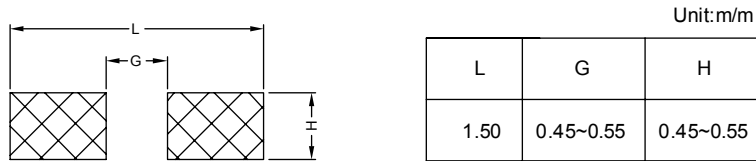

PC board should be designed so that products can prevent damage from mechanical stress when warping the board.

8-2. Soldering

Mildly activated rosin fluxes are preferred. The terminations are suitable for re-flow soldering systems. If hand soldering cannot be avoided, the preferred technique is the utilization of hot air soldering tools.

Note.

If wave soldering is used, there will be some risk.

Re-flow soldering temperatures below 240 degrees, there will be non-wetting risk

8-2.1 Lead Free Solder Re-flow :

Recommended temperature profiles for lead free re-flow soldering in Figure 1. (Referred to J-STD-020C)

8-2.2 Soldering Iron :

Products attachment with a soldering iron is discouraged due to the inherent process control limitations. If a soldering iron must be employed the following precautions are recommended. for Iron Soldering in Figure 2.

Note :

- a) Preheat circuit and products to 150° C.
- b) 350° C tip temperature for Ferrite chip bead (max)
- c) Never contact the ceramic with the iron tip
- d) 1.0mm tip diameter (max)
- e) Use a 20 watt soldering iron with tip diameter of 1.0mm
- f) Limit soldering time to 4-5 secs.

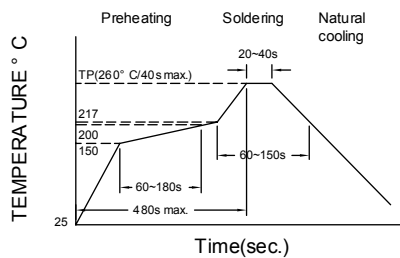

Figure 1. Re-flow Soldering:3 times max

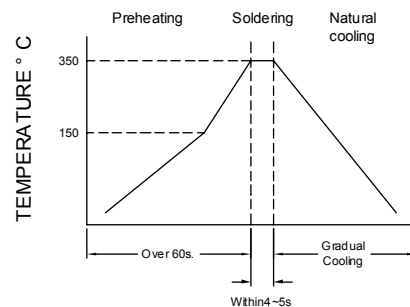

Figure 2. Wave Soldering:1 times max



RoHS Compliant

NOTE : Specifications subject to change without notice. Please check our website for latest information.



8-3. Solder Volume

Accordingly increasing the solder volume, the mechanical stress to product is also increased. Exceeding solder volume may cause the failure of mechanical or electrical performance. Solder shall be used not to be exceed as shown in Fig. 3.

Minimum fillet height = soldering thickness + 25% product height

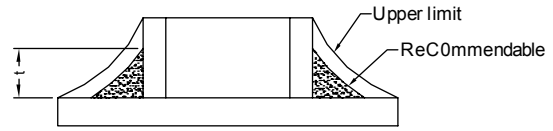

Figure 3



RoHS Compliant

NOTE : Specifications subject to change without notice. Please check our website for latest information.

26.01.2015



SUPERWORLD ELECTRONICS (S) PTE LTD

9. PACKAGING INFORMATION :

9-1. Reel Dimension

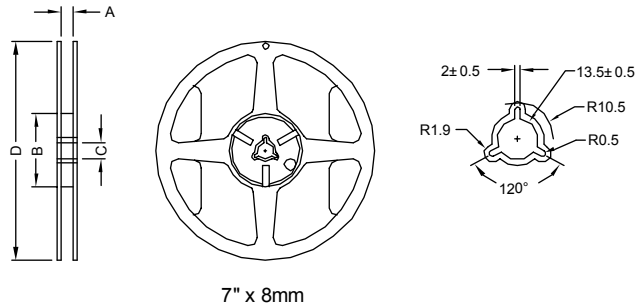

Type	A(mm)	B(mm)	C(mm)	D(mm)
7" x 8mm	9.0±0.5	60±2	13.5±0.5	178.0±2.0

9-2 Tape Dimension / 8mm

Material : Paper

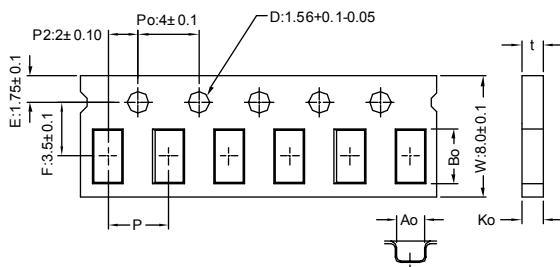

Size	Bo(mm)	Ao(mm)	Ko(mm)	P(mm)	t(mm)
C1	1.15±0.10	0.65±0.10	0.80 max	2.0±0.05	0.80 max

9-3. Packaging Quantity

Chip Size	C1
Chip / Reel	10000
Inner Box	50000
Middle Box	250000
Carton	500000



RoHS Compliant

NOTE : Specifications subject to change without notice. Please check our website for latest information.

26.01.2015



SUPERWORLD ELECTRONICS (S) PTE LTD

9-4. Tearing Off Force

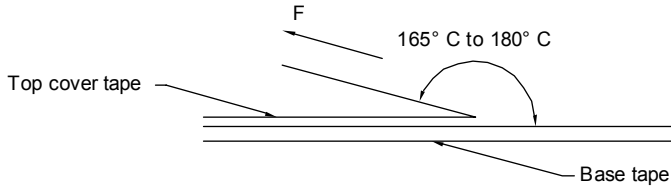

The force for tearing off cover tape is 15 to 60 grams in the arrow direction under the following conditions.

Room Temp. (° C)	Room Humidity (%)	Room atm (hPa)	Tearing Speed (mm/min)
5~35	45~85	860~1060	300

Application Notice

1. Storage Conditions :

To maintain the solderability of terminal electrodes :

- a) Recommended products should be used within 12 months from the time of delivery.
- b) The packaging material should be kept where no chlorine or sulfur exists in the air.

2. Transportation :

- a) Products should be handled with care to avoid damage or contamination from perspiration and skin oils.
- b) The use of tweezers or vacuum pick up is strongly recommended for individual components.
- c) Bulk handling should ensure that abrasion and mechanical shock are minimized.



RoHS Compliant

NOTE : Specifications subject to change without notice. Please check our website for latest information.

26.01.2015



SUPERWORLD ELECTRONICS (S) PTE LTD

PG. 8