

PLEASE CHECK WWW.MOLEX.COM FOR LATEST PART INFORMATION

Part Number: [0510351400](#)
Status: **Active**
Description: 2.50mm (.098") Pitch Board-In Housing, 14 Circuits

Documents:

3D Model	Product Specification PS-51035-002 (PDF)
Drawing (PDF)	RoHS Certificate of Compliance (PDF)
Product Specification PS-51035-001 (PDF)	

General

Product Family	Crimp Housings
Series	51035
Product Name	Board-In

Physical

Circuits (maximum)	14
Color - Resin	Natural
Gender	Male
Glow-Wire Compliant	No
Material - Resin	Nylon
Number of Rows	1
Packaging Type	Bag
Panel Mount	No
Pitch - Mating Interface (in)	0.098 In
Pitch - Mating Interface (mm)	2.50 mm
Stackable	No
Temperature Range - Operating	-40°C to +105°C

Material Info

Reference - Drawing Numbers

Product Specification	PS-51035-001, PS-51035-002, RPS-51035-001
Sales Drawing	SD-51035-**00

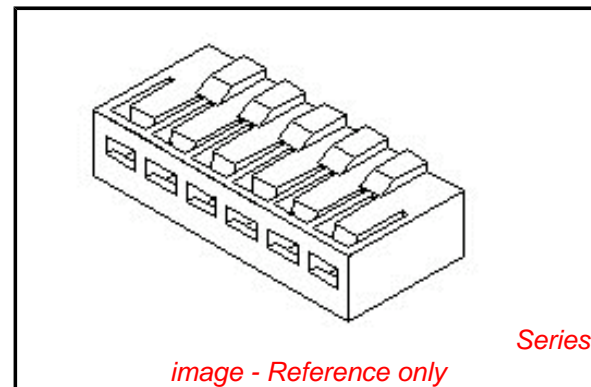

EU RoHS

**ELV and RoHS
Compliant**
**REACH SVHC
Contains SVHC: No**
**Halogen-Free
Status
Not Reviewed**

China RoHS



**Need more information on product
environmental compliance?**

Email productcompliance@molex.com
 For a multiple part number RoHS Certificate of
 Compliance, [click here](#)

Please visit the [Contact Us](#) section for any
 non-product compliance questions.

Search Parts in this Series
[51035Series](#)

Use With
[50097](#)

E

D

DIMENSIONS IN METRIC DO NOT SCALE DRAWING

A

(公差非累積)
(NON-ACCUMULATIVE)

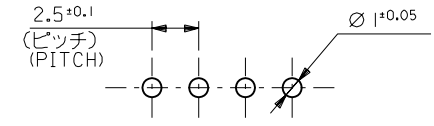

基板取付穴推奨寸法 (基板厚: 1.6mm)
RECOMMENDED PC BOARD HOLE DIMENSION
(THICKNESS: 1.6mm)

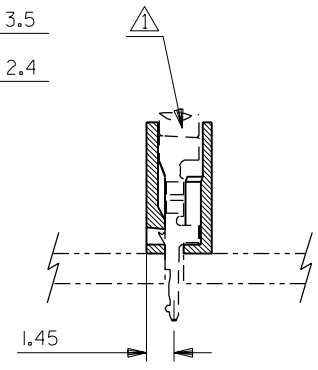
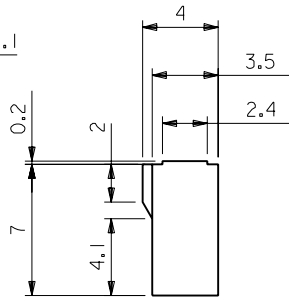
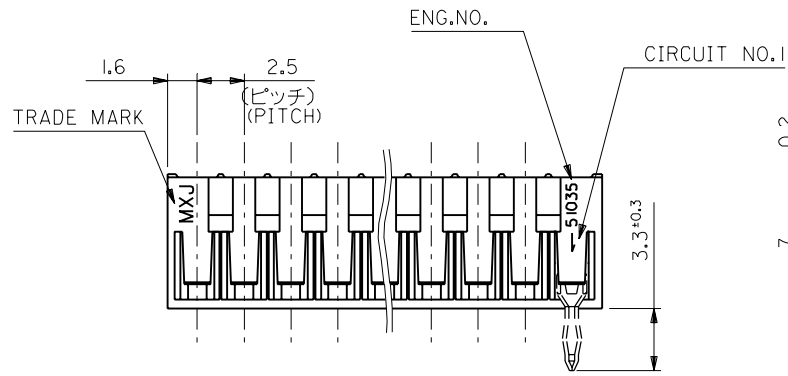
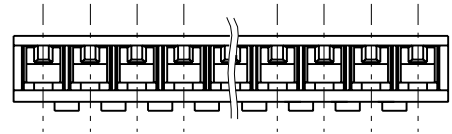

注記
NOTE

▲適合ターミナル: 50097-8*00
APPLICABLE TERMINAL: 50097-8*00

42.5	45.7	51035 - 1800	18
40.0	43.2	▲ - 1700	17
37.5	40.7	- 1600	16
35.0	38.2	- 1500	15
32.5	35.7	- 1400	14
30.0	33.2	- 1300	13
27.5	30.7	- 1200	12
25.0	28.2	- 1100	11
22.5	25.7	- 1000	10
20.0	23.2	- 0900	9
17.5	20.7	- 0800	8
15.0	18.2	- 0700	7
12.5	15.7	- 0600	6
10.0	13.2	- 0500	5
7.5	10.7	- 0400	4
5.0	8.2	▼ - 0300	3
2.5	5.7	51035 - 0200	2
B	A	ENG.NO.	極数 CKT.

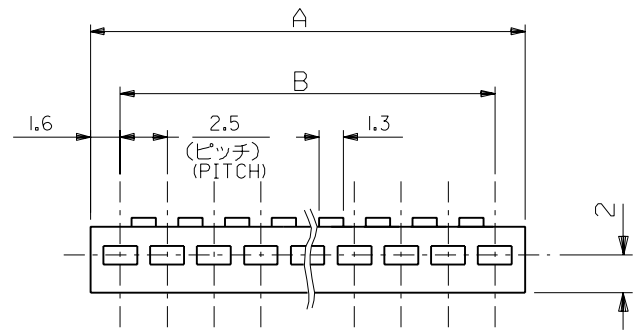

角度 ANGLE	±3°				
30以上 OVER	+0.3				
10以上 30未満 UNDER	+0.25				
10未満 UNDER	+0.2				
一般公差 GENERAL TOLERANCES					
記号 LTR	変更内容 REVISION RECORD	DR. / CHK.	日付 DATE		
E	REDRAWN	K.S. / M.S.	%/06/30		

材料 MATERIAL	NYLON66,UL94V-0
仕上げ FINISH	//
適用電線範囲 WIRE RANGE	AWG#24~20,KV0.2~0.5 AVS0.3~0.5
被覆外径 INS. RANGE	φ1.3~2.1
DRAWN BY	%/06/30 K.SANO
CHK'D BY	%/06/30 M.SAKANO
APP'D BY	%/06/30 M.ENOMOTO
尺度 SCALE	4:1

molex MOLEX-JAPAN CO.,LTD. 日本モレックス株式会社	
REVISE ONLY ON CAD SYSTEM	
TITLE 名称 2.5 BOARD IN CONN. HOUSING	
DWG. NO. SD-51035-**-00	REV E

8

7

6

5

4

3

2

1

0235.525