

PRELIMINARY DATASHEET

DATASHEET

PRODUCT : 8M (x8/x16) Flash Memory

MODEL No : ***LH28F800BJHB-PTTL90***

- This device datasheet is subject to change without notice.
- Copyright Sharp Co., Ltd. All rights reserved. No reproduction or republication without written permission.
- Contact your local Sharp sales office to obtain the latest datasheet.

- Handle this document carefully for it contains material protected by international copyright law. Any reproduction, full or in part, of this material is prohibited without the express written permission of the company.
- When using the products covered herein, please observe the conditions written herein and the precautions outlined in the following paragraphs. In no event shall the company be liable for any damages resulting from failure to strictly adhere to these conditions and precautions.
 - (1) The products covered herein are designed and manufactured for the following application areas. When using the products covered herein for the equipment listed in Paragraph (2), even for the following application areas, be sure to observe the precautions given in Paragraph (2). Never use the products for the equipment listed in Paragraph (3).
 - Office electronics
 - Instrumentation and measuring equipment
 - Machine tools
 - Audiovisual equipment
 - Home appliance
 - Communication equipment other than for trunk lines
 - (2) Those contemplating using the products covered herein for the following equipment which demands high reliability, should first contact a sales representative of the company and then accept responsibility for incorporating into the design fail-safe operation, redundancy, and other appropriate measures for ensuring reliability and safety of the equipment and the overall system.
 - Control and safety devices for airplanes, trains, automobiles, and other transportation equipment
 - Mainframe computers
 - Traffic control systems
 - Gas leak detectors and automatic cutoff devices
 - Rescue and security equipment
 - Other safety devices and safety equipment, etc.
 - (3) Do not use the products covered herein for the following equipment which demands extremely high performance in terms of functionality, reliability, or accuracy.
 - Aerospace equipment
 - Communications equipment for trunk lines
 - Control equipment for the nuclear power industry
 - Medical equipment related to life support, etc.
 - (4) Please direct all queries and comments regarding the interpretation of the above three Paragraphs to a sales representative of the company.
- Please direct all queries regarding the products covered herein to a sales representative of the company.

CONTENTS

	PAGE		PAGE
1 INTRODUCTION.....	3	5 DESIGN CONSIDERATIONS	27
1.1 Features	3	5.1 Three-Line Output Control	27
1.2 Product Overview	3	5.2 RY/BY# and WSM Polling	27
1.3 Product Description	4	5.3 Power Supply Decoupling	27
1.3.1 Package Pinout	4	5.4 V_{CCW} Trace on Printed Circuit Boards	27
1.3.2 Block Organization.....	4	5.5 V_{CC} , V_{CCW} , RP# Transitions	27
2 PRINCIPLES OF OPERATION.....	7	5.6 Power-Up/Down Protection.....	28
2.1 Data Protection.....	8	5.7 Power Dissipation	28
3 BUS OPERATION	8	5.8 Data Protection Method	28
3.1 Read.....	8	6 ELECTRICAL SPECIFICATIONS	29
3.2 Output Disable.....	8	6.1 Absolute Maximum Ratings	29
3.3 Standby.....	8	6.2 Operating Conditions	29
3.4 Reset.....	8	6.2.1 Capacitance	29
3.5 Read Identifier Codes	9	6.2.2 AC Input/Output Test Conditions	30
3.6 OTP(One Time Program) Block	9	6.2.3 DC Characteristics	31
3.7 Write.....	10	6.2.4 AC Characteristics - Read-Only Operations	33
4 COMMAND DEFINITIONS.....	10	6.2.5 AC Characteristics - Write Operations	36
4.1 Read Array Command.....	12	6.2.6 Alternative CE#-Controlled Writes.....	38
4.2 Read Identifier Codes Command	12	6.2.7 Reset Operations	40
4.3 Read Status Register Command	12	6.2.8 Block Erase, Full Chip Erase, Word/Byte Write and Lock-Bit Configuration Performance	41
4.4 Clear Status Register Command.....	12		
4.5 Block Erase Command.....	13		
4.6 Full Chip Erase Command	13		
4.7 Word/Byte Write Command.....	13		
4.8 Block Erase Suspend Command	14		
4.9 Word/Byte Write Suspend Command	14		
4.10 Set Block and Permanent Lock-Bit Commands	15		
4.11 Clear Block Lock-Bits Command	15		
4.12 OTP Program Command	16		
4.13 Block Locking by the WP#	16		

LH28F800BJHB-PTTL90

8M-BIT (512Kbit ×16 / 1Mbit ×8)

Boot Block Flash MEMORY

- Low Voltage Operation
 - $V_{CC}=V_{CCW}=2.7V-3.6V$ Single Voltage
- OTP(One Time Program) Block
 - 3963 word + 4 word Program only array
- User-Configurable ×8 or ×16 Operation
- High-Performance Read Access Time
 - 90ns($V_{CC}=2.7V-3.6V$)
- Operating Temperature
 - $-40^{\circ}C$ to $+85^{\circ}C$
- Low Power Management
 - Typ. 2 μ A ($V_{CC}=3.0V$) Standby Current
 - Automatic Power Savings Mode Decreases I_{CCR} in Static Mode
 - Typ. 120 μ A ($V_{CC}=3.0V$, $T_A=+25^{\circ}C$, $f=32kHz$) Read Current
- Optimized Array Blocking Architecture
 - Two 4K-word (8K-byte) Boot Blocks
 - Six 4K-word (8K-byte) Parameter Blocks
 - Fifteen 32K-word (64K-byte) Main Blocks
 - Top Boot Location
- Extended Cycling Capability
 - Minimum 100,000 Block Erase Cycles
- Enhanced Automated Suspend Options
 - Word/Byte Write Suspend to Read
 - Block Erase Suspend to Word/Byte Write
 - Block Erase Suspend to Read
- Enhanced Data Protection Features
 - Absolute Protection with $V_{CCW} \leq V_{CCWLK}$
 - Block Erase, Full Chip Erase, Word/Byte Write and Lock-Bit Configuration Lockout during Power Transitions
 - Block Locking with Command and WP#
 - Permanent Locking
- Automated Block Erase, Full Chip Erase, Word/Byte Write and Lock-Bit Configuration
 - Command User Interface (CUI)
 - Status Register (SR)
- SRAM-Compatible Write Interface
- Chip-Size Packaging
 - 48-Ball CSP
- ETOX™* Nonvolatile Flash Technology
- CMOS Process (P-type silicon substrate)
- Not designed or rated as radiation hardened

The product is a high-density, low-cost, nonvolatile, read/write storage solution for a wide range of applications.

The product can operate at $V_{CC}=2.7V-3.6V$ and $V_{CCW}=2.7V-3.6V$ or $11.7V-12.3V$. Its low voltage operation capability realize battery life and suits for cellular phone application.

Its Boot, Parameter and Main-blocked architecture, low voltage and extended cycling provide for highly flexible component suitable for portable terminals and personal computers. Its enhanced suspend capabilities provide for an ideal solution for code + data storage applications.

For secure code storage applications, such as networking, where code is either directly executed out of flash or downloaded to DRAM, the product offers four levels of protection: absolute protection with $V_{CCW} \leq V_{CCWLK}$, selective hardware block locking or flexible software block locking. These alternatives give designers ultimate control of their code security needs.

The product is manufactured on SHARP's 0.25 μ m ETOX™* process technology. It come in chip-size package: the 48-ball CSP, ideal for board constrained applications.

*ETOX is a trademark of Intel Corporation.

1 INTRODUCTION

This datasheet contains the product specifications. Section 1 provides a flash memory overview. Sections 2, 3, 4 and 5 describe the memory organization and functionality. Section 6 covers electrical specifications.

1.1 Features

Key enhancements of the product are:

- Single low voltage operation
- Low power consumption
- Enhanced Suspend Capabilities
- Boot Block Architecture

Please note following:

- $V_{CCW_{LK}}$ has been lowered to 1.0V to support 2.7V-3.6V block erase, full chip erase, word/byte write and lock-bit configuration operations. The V_{CCW} voltage transitions to GND is recommended for designs that switch V_{CCW} off during read operation.

1.2 Product Overview

The product is a high-performance 8M-bit Boot Block Flash memory organized as 512K-word of 16 bits or 1M-byte of 8 bits. The 512K-word/1M-byte of data is arranged in two 4K-word/8K-byte boot blocks, six 4K-word/8K-byte parameter blocks and fifteen 32K-word/64K-byte main blocks which are individually erasable, lockable and unlockable in-system. The memory map is shown in Figure 3.

The dedicated V_{CCW} pin gives complete data protection when $V_{CCW} \leq V_{CCW_{LK}}$.

A Command User Interface (CUI) serves as the interface between the system processor and internal operation of the device. A valid command sequence written to the CUI initiates device automation. An internal Write State Machine (WSM) automatically executes the algorithms and timings necessary for block erase, full chip erase, word/byte write and lock-bit configuration operations.

A block erase operation erases one of the device's 32K-word/64K-byte blocks typically within 1.2s ($3V V_{CC}$, $3V V_{CCW}$), 4K-word/8K-byte blocks typically within 0.6s ($3V V_{CC}$, $3V V_{CCW}$) independent of other blocks. Each block can be independently erased minimum 100,000 times. Block erase suspend mode allows system software to suspend block erase to read or write data from any other block.

Writing memory data is performed in word/byte increments of the device's 32K-word blocks typically within 33 μ s ($3V V_{CC}$, $3V V_{CCW}$), 64K-byte blocks typically within 31 μ s ($3V V_{CC}$, $3V V_{CCW}$), 4K-word blocks typically within 36 μ s ($3V V_{CC}$, $3V V_{CCW}$), 8K-byte blocks typically within 32 μ s ($3V V_{CC}$, $3V V_{CCW}$). Word/byte write suspend mode enables the system to read data or execute code from any other flash memory array location.

Individual block locking uses a combination of bits, thirty-nine block lock-bits, a permanent lock-bit and WP# pin, to lock and unlock blocks. Block lock-bits gate block erase, full chip erase and word/byte write operations, while the permanent lock-bit gates block lock-bit modification and locked block alternation. Lock-bit configuration operations (Set Block Lock-Bit, Set Permanent Lock-Bit and Clear Block Lock-Bits commands) set and cleared lock-bits.

The status register indicates when the WSM's block erase, full chip erase, word/byte write or lock-bit configuration operation is finished.

The RY/BY# output gives an additional indicator of WSM activity by providing both a hardware signal of status (versus software polling) and status masking (interrupt masking for background block erase, for example). Status polling using RY/BY# minimizes both CPU overhead and system power consumption. When low, RY/BY# indicates that the WSM is performing a block erase, full chip erase, word/byte write or lock-bit configuration. RY/BY#-high Z indicates that the WSM is ready for a new command, block erase is suspended (and word/byte write is inactive), word/byte write is suspended, or the device is in reset mode.

The access time is 90ns (t_{AVQV}) over the operating temperature range (-40°C to +85°C) and V_{CC} supply voltage range of 2.7V-3.6V.

The Automatic Power Savings (APS) feature substantially reduces active current when the device is in static mode (addresses not switching). In APS mode, the typical I_{CCR} current is 2 μ A (CMOS) at 3.0V V_{CC} .

When CE# and RP# pins are at V_{CC} , the I_{CC} CMOS standby mode is enabled. When the RP# pin is at GND, reset mode is enabled which minimizes power consumption and provides write protection. A reset time (t_{PHQV}) is required from RP# switching high until outputs are valid. Likewise, the device has a wake time (t_{PHEL}) from RP#-high until writes to the CUI are recognized. With RP# at GND, the WSM is reset and the status register is cleared.

Please do not execute reprogramming "0" for the bit which has already been programmed "0". Overwrite operation may generate unerasable bit. In case of reprogramming "0" to the data which has been programmed "1".

- Program "0" for the bit in which you want to change data from "1" to "0".
- Program "1" for the bit which has already been programmed "0".

For example, changing data from "10111101" to "10111100" requires "11111110" programming.

1.3 Product Description

1.3.1 Package Pinout

The product is available in 48-ball CSP package (see Figure 2).

1.3.2 Block Organization

This product features an asymmetrically-blocked architecture providing system memory integration. Each erase block can be erased independently of the others up to 100,000 times. For the address locations of the blocks, see the memory map in Figure 3.

Boot Blocks: The boot block is intended to replace a dedicated boot PROM in a microprocessor or microcontroller-based system. This boot block 4K words (4,096 words) features hardware controllable write-protection to protect the crucial microprocessor boot code from accidental modification. The protection of the boot block is controlled using a combination of the V_{CCW} , RP#, WP# pins and block lock-bit.

Parameter Blocks: The boot block architecture includes parameter blocks to facilitate storage of frequently update small parameters that would normally require an EEPROM. By using software techniques, the word-rewrite functionality of EEPROMs can be emulated. Each boot block component contains six parameter blocks of 4K words (4,096 words) each. The protection of the parameter block is controlled using a combination of the V_{CCW} , RP# and block lock-bit.

Main Blocks: The remainder is divided into main blocks for data or code storage. Each 8M-bit device contains fifteen 32K words (32,768 words) blocks. The protection of the main block is controlled using a combination of the V_{CCW} , RP# and block lock-bit.

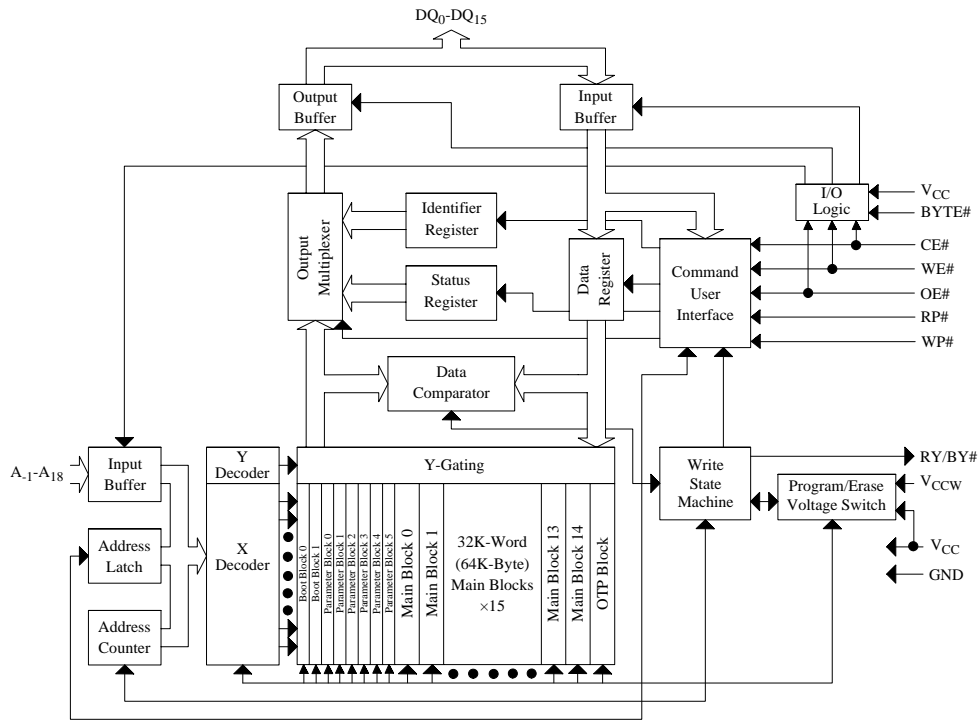
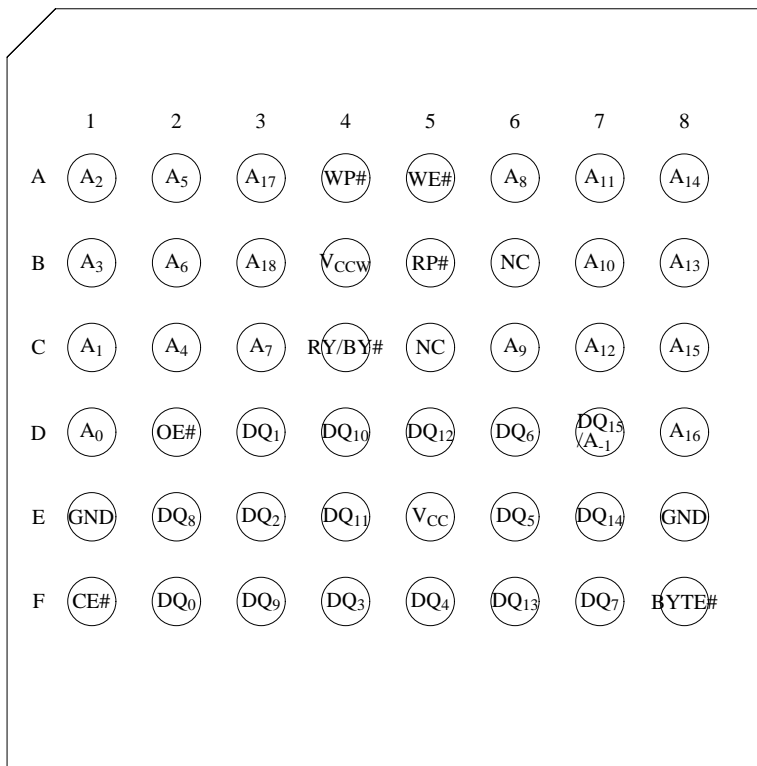

Figure 1. Block Diagram



48-BALL CSP
PINOUT
8mm x 8mm
TOP VIEW

Figure 2. CSP 48-Ball Pinout

Table 1. Pin Descriptions

Symbol	Type	Name and Function
A ₋₁ A ₀ -A ₁₈	INPUT	ADDRESS INPUTS: Inputs for addresses during read and write operations. Addresses are internally latched during a write cycle. A ₋₁ : Lower address input while BYTE# is V _{IL} . A ₋₁ pin changes DQ ₁₅ pin while BYTE# is V _{IH} . A ₁₅ -A ₁₈ : Main Block Address. A ₁₂ -A ₁₈ : Boot and Parameter Block Address.
DQ ₀ -DQ ₁₅	INPUT/ OUTPUT	DATA INPUT/OUTPUTS: Inputs data and commands during CUI write cycles; outputs data during memory array, status register and identifier code read cycles. Data pins float to high-impedance when the chip is deselected or outputs are disabled. Data is internally latched during a write cycle. DQ ₈ -DQ ₁₅ pins are not used while byte mode (BYTE#=V _{IL}). Then, DQ ₁₅ pin changes A ₋₁ address input.
CE#	INPUT	CHIP ENABLE: Activates the device's control logic, input buffers, decoders and sense amplifiers. CE#-high deselects the device and reduces power consumption to standby levels.
RP#	INPUT	RESET: Resets the device internal automation. RP#-high enables normal operation. When driven low, RP# inhibits write operations which provides data protection during power transitions. Exit from reset mode sets the device to read array mode. RP# must be V _{IL} during power-up.
OE#	INPUT	OUTPUT ENABLE: Gates the device's outputs during a read cycle.
WE#	INPUT	WRITE ENABLE: Controls writes to the CUI and array blocks. Addresses and data are latched on the rising edge of the WE# pulse.
WP#	INPUT	WRITE PROTECT: When WP# is V _{IL} , boot blocks cannot be written or erased. When WP# is V _{IH} , locked boot blocks can not be written or erased. WP# is not affected parameter and main blocks.
BYTE#	INPUT	BYTE ENABLE: BYTE# V _{IL} places device in byte mode (×8). All data is then input or output on DQ ₀₋₇ , and DQ ₈₋₁₅ float. BYTE# V _{IH} places the device in word mode (×16), and turns off the A ₋₁ input buffer.
RY/BY#	OPEN DRAIN OUTPUT	READY/BUSY#: Indicates the status of the internal WSM. When low, the WSM is performing an internal operation (block erase, full chip erase, word/byte write or lock-bit configuration). RY/BY#-high Z indicates that the WSM is ready for new commands, block erase is suspended, and word/byte write is inactive, word/byte write is suspended, or the device is in reset mode.
V _{CCW}	SUPPLY	BLOCK ERASE, FULL CHIP ERASE, WORD/BYTE WRITE OR LOCK-BIT CONFIGURATION POWER SUPPLY: For erasing array blocks, writing words/bytes or configuring lock-bits. With V _{CCW} ≤ V _{CCWLK} , memory contents cannot be altered. Block erase, full chip erase, word/byte write and lock-bit configuration with an invalid V _{CCW} (see 6.2.3 DC Characteristics) produce spurious results and should not be attempted. Applying 12V±0.3V to V _{CCW} during erase/write can only be done for a maximum of 1000 cycles on each block. V _{CCW} may be connected to 12V±0.3V for a total of 80 hours maximum.
V _{CC}	SUPPLY	DEVICE POWER SUPPLY: Do not float any power pins. With V _{CC} ≤ V _{LKO} , all write attempts to the flash memory are inhibited. Device operations at invalid V _{CC} voltage (see 6.2.3 DC Characteristics) produce spurious results and should not be attempted.
GND	SUPPLY	GROUND: Do not float any ground pins.
NC		NO CONNECT: Lead is not internal connected; it may be driven or floated.

2 PRINCIPLES OF OPERATION

The product includes an on-chip WSM to manage block erase, full chip erase, word/byte write and lock-bit configuration functions. It allows for: fixed power supplies during block erase, full chip erase, word/byte write and lock-bit configuration, and minimal processor overhead with RAM-like interface timings.

After initial device power-up or return from reset mode (see section 3 Bus Operations), the device defaults to read array mode. Manipulation of external memory control pins allow array read, standby and output disable operations.

Status register and identifier codes can be accessed through the CUI independent of the V_{CCW} voltage. High voltage on V_{CCW} enables successful block erase, full chip erase, word/byte write and lock-bit configurations. All functions associated with altering memory contents—block erase, full chip erase, word/byte write, lock-bit configuration, status and identifier codes—are accessed via the CUI and verified through the status register.

Commands are written using standard microprocessor write timings. The CUI contents serve as input to the WSM, which controls the block erase, full chip erase, word/byte write and lock-bit configuration. The internal algorithms are regulated by the WSM, including pulse repetition, internal verification and margining of data. Addresses and data are internally latched during write cycles. Writing the appropriate command outputs array data, accesses the identifier codes or outputs status register data.

Interface software that initiates and polls progress of block erase, full chip erase, word/byte write and lock-bit configuration can be stored in any block. This code is copied to and executed from system RAM during flash memory updates. After successful completion, reads are again possible via the Read Array command. Block erase suspend allows system software to suspend a block erase to read/write data from/to blocks other than that which is suspend. Word/byte write suspend allows system software to suspend a word/byte write to read data from any other flash memory array location.

[A ₁₈ -A ₀]	Top Boot	[A ₁₈ -A ₁]
7FFFF	4KW/8KB Boot Block 0	FFFF
7F000		FE000
7EFFF	4KW/8KB Boot Block 1	FDFFF
7E000		FC000
7DFFF	4KW/8KB Parameter Block 0	FBFFF
7D000		FA000
7CFFF	4KW/8KB Parameter Block 1	F9FFF
7C000		F8000
7BFFF	4KW/8KB Parameter Block 2	F7FFF
7B000		F6000
7AFFF	4KW/8KB Parameter Block 3	F5FFF
7A000		F4000
79FFF	4KW/8KB Parameter Block 4	F3FFF
79000		F2000
78FFF	4KW/8KB Parameter Block 5	F1FFF
78000		F0000
77FFF	32KW/64KB Main Block 0	FFFF
70000		E0000
6FFFF	32KW/64KB Main Block 1	DFFFF
68000		D0000
67FFF	32KW/64KB Main Block 2	CEFFF
60000		C0000
5FFFF	32KW/64KB Main Block 3	BFFFF
58000		B0000
57FFF	32KW/64KB Main Block 4	AFFFF
50000		A0000
4FFFF	32KW/64KB Main Block 5	9FFFF
48000		90000
47FFF	32KW/64KB Main Block 6	8FFFF
40000		80000
3FFFF	32KW/64KB Main Block 7	7FFFF
38000		70000
37FFF	32KW/64KB Main Block 8	6FFFF
30000		60000
2FFFF	32KW/64KB Main Block 9	5FFFF
28000		50000
27FFF	32KW/64KB Main Block 10	4FFFF
20000		40000
1FFFF	32KW/64KB Main Block 11	3FFFF
18000		30000
17FFF	32KW/64KB Main Block 12	2FFFF
10000		20000
0FFFF	32KW/64KB Main Block 13	1FFFF
08000		10000
07FFF	32KW/64KB Main Block 14	0FFFF
00000		00000

Figure 3. Memory Map

2.1 Data Protection

When $V_{CCW} \leq V_{CCWLK}$, memory contents cannot be altered. The CUI, with two-step block erase, full chip erase, word/byte write or lock-bit configuration command sequences, provides protection from unwanted operations even when high voltage is applied to V_{CCW} . All write functions are disabled when V_{CC} is below the write lockout voltage V_{LKO} or when $RP\#$ is at V_{IL} . The device's block locking capability provides additional protection from inadvertent code or data alteration by gating block erase, full chip erase and word/byte write operations. Refer to Table 5 for write protection alternatives.

3 BUS OPERATION

The local CPU reads and writes flash memory in-system. All bus cycles to or from the flash memory conform to standard microprocessor bus cycles.

3.1 Read

Information can be read from any block, identifier codes or status register independent of the V_{CCW} voltage. $RP\#$ can be at V_{IH} .

The first task is to write the appropriate read mode command (Read Array, Read Identifier Codes or Read Status Register) to the CUI. Upon initial device power-up or after exit from reset mode, the device automatically resets to read array mode. Six control pins dictate the data flow in and out of the component: $CE\#$, $OE\#$, $BYTE\#$, $WE\#$, $RP\#$ and $WP\#$. $CE\#$ and $OE\#$ must be driven active to obtain data at the outputs. $CE\#$ is the device selection control, and when active enables the selected memory device. $OE\#$ is the data output (DQ_0 - DQ_{15}) control and when active drives the selected memory data onto the I/O bus. $BYTE\#$ is the device I/O interface mode control. $WE\#$ must be at V_{IH} , $RP\#$ must be at V_{IH} , and $BYTE\#$ and $WP\#$ must be at V_{IL} or V_{IH} . Figure 16, 17 illustrates read cycle.

3.2 Output Disable

With $OE\#$ at a logic-high level (V_{IH}), the device outputs are disabled. Output pins (DQ_0 - DQ_{15}) are placed in a high-impedance state.

3.3 Standby

$CE\#$ at a logic-high level (V_{IH}) places the device in standby mode which substantially reduces device power consumption. DQ_0 - DQ_{15} outputs are placed in a high-impedance state independent of $OE\#$. If deselected during block erase, full chip erase, word/byte write or lock-bit configuration, the device continues functioning, and consuming active power until the operation completes.

3.4 Reset

$RP\#$ at V_{IL} initiates the reset mode.

In read modes, $RP\#$ -low deselects the memory, places output drivers in a high-impedance state and turns off all internal circuits. $RP\#$ must be held low for a minimum of 100ns. Time t_{PHQV} is required after return from reset mode until initial memory access outputs are valid. After this wake-up interval, normal operation is restored. The CUI is reset to read array mode and status register is set to 80H.

During block erase, full chip erase, word/byte write or lock-bit configuration modes, $RP\#$ -low will abort the operation. $RY/BY\#$ remains low until the reset operation is complete. Memory contents being altered are no longer valid; the data may be partially erased or written. Time t_{PHWL} is required after $RP\#$ goes to logic-high (V_{IH}) before another command can be written.

As with any automated device, it is important to assert $RP\#$ during system reset. When the system comes out of reset, it expects to read from the flash memory. Automated flash memories provide status information when accessed during block erase, full chip erase, word/byte write or lock-bit configuration modes. If a CPU reset occurs with no flash memory reset, proper CPU initialization may not occur because the flash memory may be providing status information instead of array data. SHARP's flash memories allow proper CPU initialization following a system reset through the use of the $RP\#$ input. In this application, $RP\#$ is controlled by the same $RESET\#$ signal that resets the system CPU.

3.5 Read Identifier Codes

The read identifier codes operation outputs the manufacturer code, device code, block lock configuration codes for each block and the permanent lock configuration code (see Figure 4). Using the manufacturer and device codes, the system CPU can automatically match the device with its proper algorithms. The block lock and permanent lock configuration codes identify locked and unlocked blocks and permanent lock-bit setting.

[A ₁₈ -A ₀]	Top Boot	[A ₁₈ -A ₁]
7FFF	Reserved for Future Implementation	FFFF
7F003		FE006
7F002	Boot Block 0 Lock Configuration Code	FE005 FE004
7F001	Reserved for Future Implementation	FE003
7F000	Boot Block 0	FE000
7EFFF	Reserved for Future Implementation	FDFFF
7E003		FC006
7E002	Boot Block 1 Lock Configuration Code	FC005 FC004
7E001	Reserved for Future Implementation	FC003
7E000	Boot Block 1	FC000
7DFFF	Reserved for Future Implementation	FBFFF
7D003		FA006
7D002	Parameter Block 0 Lock Configuration Code	FA005 FA004
7D001	Reserved for Future Implementation	FA003
7D000	Parameter Block 0	FA000
7CFFF	(Parameter Blocks 1 through 4)	F9FFF
79000		F2000
78FFF	Reserved for Future Implementation	F1FFF
78003		F0006
78002	Parameter Block 5 Lock Configuration Code	F0005 F0004
78001	Reserved for Future Implementation	F0003
78000	Parameter Block 5	F0000
77FFF	Reserved for Future Implementation	EFFFF
70003		E0006
70002	Main Block 0 Lock Configuration Code	E0005 E0004
70001	Reserved for Future Implementation	E0003
70000	Main Block 0	E0000
6FFFF	(Main Blocks 1 through 13)	DFFFF
08000		10000
07FFF	Reserved for Future Implementation	0FFFF
01000		02000
00FFF	OTP Block	01FFF
00080		00100
0007F	Reserved for Future Implementation	000FF
00004		00008
00003	Permanent Lock Configuration Code	00007 00006
00002	Main Block 14 Lock Configuration Code	00005 00004
00001	Device Code	00003 00002
00000	Manufacturer Code Main Block 14	00001 00000

Figure 4. Device Identifier Code Memory Map

3.6 OTP(One Time Program) Block

The OTP block is a special block that can not be erased. The block is divided into two parts. One is a factory program area where a unique number can be written according to customer requirements in SHARP factory. This factory program area is "READ ONLY" (Already locked). The other is a customer program area that can be used by customers. This customer program area can be locked. After locking, this customer program area is protected permanently.

The OTP block is read in Configuration Read Mode by writing Read Identifier Codes command(90H). To return to Read Array Mode, write Read Array command(FFH).

The OTP block is programmed by writing OTP Program command(C0H). First write OTP Program command and then write data with address to the device (See Figure 5). If OTP program is failed, SR.4(WORD/BYTE WRITE AND SET LOCK-BIT STATUS) bit is set to "1". And if this OTP block is locked, SR.1(DEVICE PROTECT STATUS) bit is set to "1" too.

The OTP block is also locked by writing OTP Program command(C0H). First write OTP Program command and then write data "FFFDH" with address "80H" to the device. Address "80H" of OTP block is OTP lock information. Bit 0 of address "80H" means factory program area lock status("1" is "NOT LOCKED", "0" is "LOCKED"). Bit 1 of address "80H" means customer program area lock status. The OTP lock information can not be cleared, after once it is set.

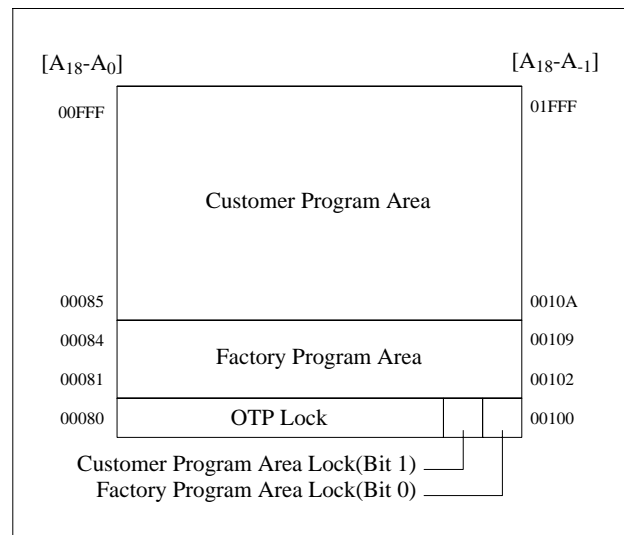

Figure 5. OTP Block Address Map

3.7 Write

Writing commands to the CUI enable reading of device data and identifier codes. They also control inspection and clearing of the status register. When $V_{CC}=2.7V-3.6V$ and $V_{CCW}=V_{CCWH1/2}$, the CUI additionally controls block erase, full chip erase, word/byte write and lock-bit configuration.

The Block Erase command requires appropriate command data and an address within the block to be erased. The Full Chip Erase command requires appropriate command data and an address within the device. The Word/Byte Write command requires the command and address of the location to be written. Set Permanent and Block Lock-Bit commands require the command and address within the device (Permanent Lock) or block within the device (Block Lock) to be locked. The Clear Block Lock-Bits command requires the command and address within the device.

The CUI does not occupy an addressable memory location. It is written when WE# and CE# are active. The address and data needed to execute a command are latched on the rising edge of WE# or CE# (whichever goes high first). Standard microprocessor write timings are used. Figures 18 and 19 illustrate WE# and CE# controlled write operations.

4 COMMAND DEFINITIONS

When the V_{CCW} voltage $\leq V_{CCWLK}$, read operations from the status register, identifier codes, or blocks are enabled. Placing $V_{CCWH1/2}$ on V_{CCW} enables successful block erase, full chip erase, word/byte write and lock-bit configuration operations.

Device operations are selected by writing specific commands into the CUI. Table 3 defines these commands.

Table 2.1. Bus Operations (BYTE#=V_{IH})^(1,2)

Mode	Notes	RP#	CE#	OE#	WE#	Address	V _{CCW}	DQ ₀₋₁₅	RY/BY# ⁽³⁾
Read	8	V _{IH}	V _{IL}	V _{IL}	V _{IH}	X	X	D _{OUT}	X
Output Disable		V _{IH}	V _{IL}	V _{IH}	V _{IH}	X	X	High Z	X
Standby		V _{IH}	V _{IH}	X	X	X	X	High Z	X
Reset	4	V _{IL}	X	X	X	X	X	High Z	High Z
Read Identifier Codes	8	V _{IH}	V _{IL}	V _{IL}	V _{IH}	See Figure 4, 5	X	Note 5	High Z
Write	6,7,8	V _{IH}	V _{IL}	V _{IH}	V _{IL}	X	X	D _{IN}	X

Table 2.2. Bus Operations (BYTE#=V_{IL})^(1,2)

Mode	Notes	RP#	CE#	OE#	WE#	Address	V _{CCW}	DQ ₀₋₇	RY/BY# ⁽³⁾
Read	8	V _{IH}	V _{IL}	V _{IL}	V _{IH}	X	X	D _{OUT}	X
Output Disable		V _{IH}	V _{IL}	V _{IH}	V _{IH}	X	X	High Z	X
Standby		V _{IH}	V _{IH}	X	X	X	X	High Z	X
Reset	4	V _{IL}	X	X	X	X	X	High Z	High Z
Read Identifier Codes	8	V _{IH}	V _{IL}	V _{IL}	V _{IH}	See Figure 4, 5	X	Note 5	High Z
Write	6,7,8	V _{IH}	V _{IL}	V _{IH}	V _{IL}	X	X	D _{IN}	X

NOTES:

1. Refer to DC Characteristics. When $V_{CCW} \leq V_{CCWLK}$, memory contents can be read, but not altered.
2. X can be V_{IL} or V_{IH} for control pins and addresses, and V_{CCWLK} or V_{CCWH1/2} for V_{CCW}. See DC Characteristics for V_{CCWLK} voltages.
3. RY/BY# is V_{OL} when the WSM is executing internal block erase, full chip erase, word/byte write or lock-bit configuration algorithms. It is High Z during when the WSM is not busy, in block erase suspend mode (with word/byte write inactive), word/byte write suspend mode or reset mode.
4. RP# at GND±0.2V ensures the lowest power consumption.
5. See Section 4.2 for read identifier code data.
6. Command writes involving block erase, full chip erase, word/byte write or lock-bit configuration are reliably executed when $V_{CCW}=V_{CCWH1/2}$ and $V_{CC}=2.7V-3.6V$.
7. Refer to Table 3 for valid D_{IN} during a write operation.
8. Never hold OE# low and WE# low at the same timing.

Table 3. Command Definitions⁽¹⁰⁾

Command	Bus Cycles Req'd.	Notes	First Bus Cycle			Second Bus Cycle		
			Oper ⁽¹⁾	Addr ⁽²⁾	Data ⁽³⁾	Oper ⁽¹⁾	Addr ⁽²⁾	Data ⁽³⁾
Read Array/Reset	1		Write	X	FFH			
Read Identifier Codes	≥2	4	Write	X	90H	Read	IA	ID
Read Status Register	2		Write	X	70H	Read	X	SRD
Clear Status Register	1		Write	X	50H			
Block Erase	2	5	Write	X	20H	Write	BA	D0H
Full Chip Erase	2		Write	X	30H	Write	X	D0H
Word/Byte Write	2	5,6	Write	X	40H or 10H	Write	WA	WD
Block Erase and Word/Byte Write Suspend	1	5	Write	X	B0H			
Block Erase and Word/Byte Write Resume	1	5	Write	X	D0H			
Set Block Lock-Bit	2	8	Write	X	60H	Write	BA	01H
Clear Block Lock-Bits	2	7,8	Write	X	60H	Write	X	D0H
Set Permanent Lock-Bit	2	9	Write	X	60H	Write	X	F1H
OTP Program	2		Write	X	C0H	Write	OA	OD

NOTES:

- BUS operations are defined in Table 2.1 and Table 2.2.
- X=Any valid address within the device.
IA=Identifier Code Address: see Figure 4.
BA=Address within the block being erased or locked.
WA=Address of memory location to be written.
OA=Address of OTP block to be written: see Figure 5.
- ID=Data read from identifier codes.
SRD=Data read from status register. See Table 6 for a description of the status register bits.
WD=Data to be written at location WA. Data is latched on the rising edge of WE# or CE# (whichever goes high first).
OD=Data to be written at location OA. Data is latched on the rising edge of WE# or CE# (whichever goes high first).
- Following the Read Identifier Codes command, read operations access manufacturer, device, block lock configuration and permanent lock configuration codes. See Section 4.2 for read identifier code data.
- If WP# is V_{IL}, boot blocks are locked without block lock-bits state. If WP# is V_{IH}, boot blocks are locked by block lock-bits. The parameter and main blocks are locked by block lock-bits without WP# state.
- Either 40H or 10H are recognized by the WSM as the word/byte write setup.
- The clear block lock-bits operation simultaneously clears all block lock-bits.
- If the permanent lock-bit is set, Set Block Lock-Bit and Clear Block Lock-Bits commands can not be done.
- Once the permanent lock-bit is set, permanent lock-bit reset is unable.
- Commands other than those shown above are reserved by SHARP for future device implementations and should not be used.

4.1 Read Array Command

Upon initial device power-up and after exit from reset mode, the device defaults to read array mode. This operation is also initiated by writing the Read Array command. The device remains enabled for reads until another command is written. Once the internal WSM has started a block erase, full chip erase, word/byte write or lock-bit configuration the device will not recognize the Read Array command until the WSM completes its operation unless the WSM is suspended via an Erase Suspend or Word/Byte Write Suspend command. The Read Array command functions independently of the V_{CCW} voltage and RP# can be V_{IH} .

4.2 Read Identifier Codes Command

The identifier code operation is initiated by writing the Read Identifier Codes command. Following the command write, read cycles from addresses shown in Figure 4 retrieve the manufacturer, device, block lock configuration and permanent lock configuration codes (see Table 4 for identifier code values). To terminate the operation, write another valid command. Like the Read Array command, the Read Identifier Codes command functions independently of the V_{CCW} voltage and RP# can be V_{IH} . Following the Read Identifier Codes command, the following information can be read:

Table 4. Identifier Codes

Code	Address ⁽²⁾ [A ₁₈ -A ₀]	Data ⁽³⁾ [DQ ₇ -DQ ₀]
Manufacture Code	00000H	B0H
Device Code	00001H	ECH
Block Lock Configuration	BA ⁽¹⁾ +2	
•Block is Unlocked		DQ ₀ =0
•Block is Locked		DQ ₀ =1
•Reserved for Future Use		DQ ₁₋₇
Permanent Lock Configuration	00003H	
•Device is Unlocked		DQ ₀ =0
•Device is Locked		DQ ₀ =1
•Reserved for Future Use		DQ ₁₋₇

NOTE:

1. BA selects the specific block lock configuration code to be read. See Figure 4 for the device identifier code memory map.
2. A₁ don't care in byte mode.
3. DQ₁₅-DQ₈ outputs 00H in word mode.

4.3 Read Status Register Command

The status register may be read to determine when a block erase, full chip erase, word/byte write or lock-bit configuration is complete and whether the operation completed successfully. It may be read at any time by writing the Read Status Register command. After writing this command, all subsequent read operations output data from the status register until another valid command is written. The status register contents are latched on the falling edge of OE# or CE#, whichever occurs. OE# or CE# must toggle to V_{IH} before further reads to update the status register latch. The Read Status Register command functions independently of the V_{CCW} voltage. RP# can be V_{IH} .

4.4 Clear Status Register Command

Status register bits SR.5, SR.4, SR.3 or SR.1 are set to "1"s by the WSM and can only be reset by the Clear Status Register command. These bits indicate various failure conditions (see Table 6). By allowing system software to reset these bits, several operations (such as cumulatively erasing multiple blocks or writing several words/bytes in sequence) may be performed. The status register may be polled to determine if an error occurred during the sequence.

To clear the status register, the Clear Status Register command (50H) is written. It functions independently of the applied V_{CCW} Voltage. RP# can be V_{IH} . This command is not functional during block erase or word/byte write suspend modes.

4.5 Block Erase Command

Erase is executed one block at a time and initiated by a two-cycle command. A block erase setup is first written, followed by an block erase confirm. This command sequence requires appropriate sequencing and an address within the block to be erased (erase changes all block data to FFFFH/FFH). Block preconditioning, erase, and verify are handled internally by the WSM (invisible to the system). After the two-cycle block erase sequence is written, the device automatically outputs status register data when read (see Figure 6). The CPU can detect block erase completion by analyzing the output data of the RY/BY# pin or status register bit SR.7.

When the block erase is complete, status register bit SR.5 should be checked. If a block erase error is detected, the status register should be cleared before system software attempts corrective actions. The CUI remains in read status register mode until a new command is issued.

This two-step command sequence of set-up followed by execution ensures that block contents are not accidentally erased. An invalid Block Erase command sequence will result in both status register bits SR.4 and SR.5 being set to "1". Also, reliable block erasure can only occur when $V_{CC}=2.7V-3.6V$ and $V_{CCW}=V_{CCWH1/2}$. In the absence of this high voltage, block contents are protected against erasure. If block erase is attempted while $V_{CCW}\leq V_{CCWLK}$, SR.3 and SR.5 will be set to "1". Successful block erase requires for boot blocks that WP# is V_{IH} and the corresponding block lock-bit be cleared. In parameter and main blocks case, it must be cleared the corresponding block lock-bit. If block erase is attempted when the excepting above conditions, SR.1 and SR.5 will be set to "1".

4.6 Full Chip Erase Command

This command followed by a confirm command erases all of the unlocked blocks. A full chip erase setup (30H) is first written, followed by a full chip erase confirm (D0H). After a confirm command is written, device erases the all unlocked blocks block by block. This command sequence requires appropriate sequencing. Block preconditioning, erase and verify are handled internally by the WSM (invisible to the system). After the two-cycle full chip erase sequence is written, the device automatically outputs status register data when read (see Figure 7). The CPU can detect full chip erase completion by analyzing the output data of the RY/BY# pin or status register bit SR.7.

When the full chip erase is complete, status register bit SR.5 should be checked. If erase error is detected, the status register should be cleared before system software attempts corrective actions. The CUI remains in read

status register mode until a new command is issued. If error is detected on a block during full chip erase operation, WSM stops erasing. Full chip erase operation start from lower address block, finish the higher address block. Full chip erase can not be suspended.

This two-step command sequence of set-up followed by execution ensures that block contents are not accidentally erased. An invalid Full Chip Erase command sequence will result in both status register bits SR.4 and SR.5 being set to "1". Also, reliable full chip erasure can only occur when $V_{CC}=2.7V-3.6V$ and $V_{CCW}=V_{CCWH1/2}$. In the absence of this high voltage, block contents are protected against erasure. If full chip erase is attempted while $V_{CCW}\leq V_{CCWLK}$, SR.3 and SR.5 will be set to "1". Successful full chip erase requires for boot blocks that WP# is V_{IH} and the corresponding block lock-bit be cleared. In parameter and main blocks case, it must be cleared the corresponding block lock-bit. If all blocks are locked, SR.1 and SR.5 will be set to "1".

4.7 Word/Byte Write Command

Word/Byte write is executed by a two-cycle command sequence. Word/Byte write setup (standard 40H or alternate 10H) is written, followed by a second write that specifies the address and data (latched on the rising edge of WE#). The WSM then takes over, controlling the word/byte write and write verify algorithms internally. After the word/byte write sequence is written, the device automatically outputs status register data when read (see Figure 8). The CPU can detect the completion of the word/byte write event by analyzing the RY/BY# pin or status register bit SR.7.

When word/byte write is complete, status register bit SR.4 should be checked. If word/byte write error is detected, the status register should be cleared. The internal WSM verify only detects errors for "1"s that do not successfully write to "0"s. The CUI remains in read status register mode until it receives another command.

Reliable word/byte writes can only occur when $V_{CC}=2.7V-3.6V$ and $V_{CCW}=V_{CCWH1/2}$. In the absence of this high voltage, memory contents are protected against word/byte writes. If word/byte write is attempted while $V_{CCW}\leq V_{CCWLK}$, status register bits SR.3 and SR.4 will be set to "1". Successful word/byte write requires for boot blocks that WP# is V_{IH} and the corresponding block lock-bit be cleared. In parameter and main blocks case, it must be cleared the corresponding block lock-bit. If word/byte write is attempted when the excepting above conditions, SR.1 and SR.4 will be set to "1".

4.8 Block Erase Suspend Command

The Block Erase Suspend command allows block-erase interruption to read or word/byte write data in another block of memory. Once the block erase process starts, writing the Block Erase Suspend command requests that the WSM suspend the block erase sequence at a predetermined point in the algorithm. The device outputs status register data when read after the Block Erase Suspend command is written. Polling status register bits SR.7 and SR.6 can determine when the block erase operation has been suspended (both will be set to "1"). RY/BY# will also transition to High Z. Specification t_{WHRZ2} defines the block erase suspend latency.

When Block Erase Suspend command write to the CUI, if block erase was finished, the device places read array mode. Therefore, after Block Erase Suspend command write to the CUI, Read Status Register command (70H) has to write to CUI, then status register bit SR.6 should be checked for places the device in suspend mode.

At this point, a Read Array command can be written to read data from blocks other than that which is suspended. A Word/Byte Write command sequence can also be issued during erase suspend to program data in other blocks. Using the Word/Byte Write Suspend command (see Section 4.9), a word/byte write operation can also be suspended. During a word/byte write operation with block erase suspended, status register bit SR.7 will return to "0" and the RY/BY# output will transition to V_{OL} . However, SR.6 will remain "1" to indicate block erase suspend status.

The only other valid commands while block erase is suspended are Read Status Register and Block Erase Resume. After a Block Erase Resume command is written to the flash memory, the WSM will continue the block erase process. Status register bits SR.6 and SR.7 will automatically clear and RY/BY# will return to V_{OL} . After the Erase Resume command is written, the device automatically outputs status register data when read (see Figure 9). V_{CCW} must remain at $V_{CCWH1/2}$ (the same V_{CCW} level used for block erase) while block erase is suspended. RP# must also remain at V_{IH} . WP# must also remain at V_{IL} or V_{IH} (the same WP# level used for block erase). Block erase cannot resume until word/byte write operations initiated during block erase suspend have completed.

If the time between writing the Block Erase Resume command and writing the Block Erase Suspend command is shorter than t_{ERES} and both commands are written repeatedly, a longer time is required than standard block erase until the completion of the operation.

4.9 Word/Byte Write Suspend Command

The Word/Byte Write Suspend command allows word/byte write interruption to read data in other flash memory locations. Once the word/byte write process starts, writing the Word/Byte Write Suspend command requests that the WSM suspend the Word/Byte write sequence at a predetermined point in the algorithm. The device continues to output status register data when read after the Word/Byte Write Suspend command is written. Polling status register bits SR.7 and SR.2 can determine when the word/byte write operation has been suspended (both will be set to "1"). RY/BY# will also transition to High Z. Specification t_{WHRZ1} defines the word/byte write suspend latency.

When Word/Byte Write Suspend command write to the CUI, if word/byte write was finished, the device places read array mode. Therefore, after Word/Byte Write Suspend command write to the CUI, Read Status Register command (70H) has to write to CUI, then status register bit SR.2 should be checked for places the device in suspend mode.

At this point, a Read Array command can be written to read data from locations other than that which is suspended. The only other valid commands while word/byte write is suspended are Read Status Register and Word/Byte Write Resume. After Word/Byte Write Resume command is written to the flash memory, the WSM will continue the word/byte write process. Status register bits SR.2 and SR.7 will automatically clear and RY/BY# will return to V_{OL} . After the Word/Byte Write Resume command is written, the device automatically outputs status register data when read (see Figure 10). V_{CCW} must remain at $V_{CCWH1/2}$ (the same V_{CCW} level used for word/byte write) while in word/byte write suspend mode. RP# must also remain at V_{IH} . WP# must also remain at V_{IL} or V_{IH} (the same WP# level used for word/byte write).

If the time between writing the Word/Byte Write Resume command and writing the Word/Byte Write Suspend command is short and both commands are written repeatedly, a longer time is required than standard word/byte write until the completion of the operation.

4.10 Set Block and Permanent Lock-Bit Commands

A flexible block locking and unlocking scheme is enabled via a combination of block lock-bits, a permanent lock-bit and WP# pin. The block lock-bits and WP# pin gates program and erase operations while the permanent lock-bit gates block-lock bit modification. With the permanent lock-bit not set, individual block lock-bits can be set using the Set Block Lock-Bit command. The Set Permanent Lock-Bit command, sets the permanent lock-bit. After the permanent lock-bit is set, block lock-bits and locked block contents cannot be altered. See Table 5 for a summary of hardware and software write protection options.

Set block lock-bit and permanent lock-bit are executed by a two-cycle command sequence. The set block or permanent lock-bit setup along with appropriate block or device address is written followed by either the set block lock-bit confirm (and an address within the block to be locked) or the set permanent lock-bit confirm (and any device address). The WSM then controls the set lock-bit algorithm. After the sequence is written, the device automatically outputs status register data when read (see Figure 11). The CPU can detect the completion of the set lock-bit event by analyzing the RY/BY# pin output or status register bit SR.7.

When the set lock-bit operation is complete, status register bit SR.4 should be checked. If an error is detected, the status register should be cleared. The CUI will remain in read status register mode until a new command is issued.

This two-step sequence of set-up followed by execution ensures that lock-bits are not accidentally set. An invalid Set Block or Permanent Lock-Bit command will result in status register bits SR.4 and SR.5 being set to "1". Also, reliable operations occur only when $V_{CC}=2.7V-3.6V$ and $V_{CCW}=V_{CCWH1/2}$. In the absence of this high voltage, lock-bit contents are protected against alteration.

A successful set block lock-bit operation requires that the permanent lock-bit be cleared. If it is attempted with the permanent lock-bit set, SR.1 and SR.4 will be set to "1" and the operation will fail.

4.11 Clear Block Lock-Bits Command

All set block lock-bits are cleared in parallel via the Clear Block Lock-Bits command. With the permanent lock-bit not set, block lock-bits can be cleared using only the Clear Block Lock-Bits command. If the permanent lock-bit is set, block lock-bits cannot be cleared. See Table 5 for a summary of hardware and software write protection options.

Clear block lock-bits operation is executed by a two-cycle command sequence. A clear block lock-bits setup is first written. After the command is written, the device automatically outputs status register data when read (see Figure 12). The CPU can detect completion of the clear block lock-bits event by analyzing the RY/BY# Pin output or status register bit SR.7.

When the operation is complete, status register bit SR.5 should be checked. If a clear block lock-bit error is detected, the status register should be cleared. The CUI will remain in read status register mode until another command is issued.

This two-step sequence of set-up followed by execution ensures that block lock-bits are not accidentally cleared. An invalid Clear Block Lock-Bits command sequence will result in status register bits SR.4 and SR.5 being set to "1". Also, a reliable clear block lock-bits operation can only occur when $V_{CC}=2.7V-3.6V$ and $V_{CCW}=V_{CCWH1/2}$. If a clear block lock-bits operation is attempted while $V_{CCW} \leq V_{CCWLK}$, SR.3 and SR.5 will be set to "1". In the absence of this high voltage, the block lock-bits content are protected against alteration. A successful clear block lock-bits operation requires that the permanent lock-bit is not set. If it is attempted with the permanent lock-bit set, SR.1 and SR.5 will be set to "1" and the operation will fail.

If a clear block lock-bits operation is aborted due to V_{CCW} or V_{CC} transitioning out of valid range or RP# active transition, block lock-bit values are left in an undetermined state. A repeat of clear block lock-bits is required to initialize block lock-bit contents to known values. Once the permanent lock-bit is set, it cannot be cleared.

4.12 OTP Program Command

OTP program is executed by a two-cycle command sequence. OTP program command(C0H) is written, followed by a second write cycle that specifies the address and data (latched on the rising edge of WE#). The WSM then takes over, controlling the OTP program and program verify algorithms internally. After the OTP program command sequence is completed, the device automatically outputs status register data when read (see Figure 13). The CPU can detect the completion of the OTP program by analyzing the output data of the RY/BY# pin or status register bit SR.7.

When OTP program is completed, status register bit SR.4 should be checked. If OTP program error is detected, the status register should be cleared. The internal WSM verify only detects errors for "1"s that do not successfully program to "0"s. The CUI remains in read status register mode until it receives other commands.

Reliable OTP program can be executed only when $V_{CC}=2.7V-3.6V$ and $V_{CCW}=V_{CCWH1/2}$. In the absence of this voltage, memory contents are protected against OTP

programs. If OTP program is attempted while $V_{CCW} \leq V_{CCWLK}$, status register bits SR.3 and SR.4 is set to "1". If OTP write is attempted when the OTP Lock-bit is set, SR.1 and SR.4 is set to "1".

4.13 Block Locking by the WP#

This Boot Block Flash memory architecture features two hardware-lockable boot blocks so that the kernel code for the system can be kept secure while other blocks are programmed or erased as necessary.

The lockable two boot blocks are locked when $WP\#=V_{IL}$; any program or erase operation to a locked block will result in an error, which will be reflected in the status register. For top configuration, the top two boot blocks are lockable. For the bottom configuration, the bottom two boot blocks are lockable. If $WP\#$ is V_{IH} and block lock-bit is not set, boot block can be programmed or erased normally (Unless V_{CCW} is below V_{CCWLK}). $WP\#$ is valid only two boot blocks, other blocks are not affected.

Table 5. Write Protection Alternatives⁽¹⁾

Operation	V _{CCWLK}	RP#	Permanent Lock-Bit	Block Lock-bit	WP#	Effect
Block Erase or Word/Byte Write	≤V _{CCWLK}	X	X	X	X	All Blocks Locked.
	>V _{CCWLK}	V _{IL}	X	X	X	All Blocks Locked.
		V _{IH}	X	0	V _{IL}	2 Boot Blocks Locked.
					V _{IH}	Block Erase and Word/Byte Write Enabled.
		1	V _{IL}	Block Erase and Word/Byte Write Disabled.		
V _{IH}	Block Erase and Word/Byte Write Disabled.					
Full Chip Erase	≤V _{CCWLK}	X	X	X	X	All Blocks Locked.
	>V _{CCWLK}	V _{IL}	X	X	X	All Blocks Locked.
		V _{IH}	X	X	V _{IL}	All Unlocked Blocks are Erased. 2 Boot Blocks and Locked Blocks are NOT Erased.
					V _{IH}	All Unlocked Blocks are Erased, Locked Blocks are NOT Erased.
Set Block Lock-Bit	≤V _{CCWLK}	X	X	X	X	Set Block Lock-Bit Disabled.
	>V _{CCWLK}	V _{IL}	X	X	X	Set Block Lock-Bit Disabled.
		V _{IH}	0	X	X	Set Block Lock-Bit Enabled.
			1	X	X	Set Block Lock-Bit Disabled.
Clear Block Lock-Bits	≤V _{CCWLK}	X	X	X	X	Clear Block Lock-Bits Disabled.
	>V _{CCWLK}	V _{IL}	X	X	X	Clear Block Lock-Bits Disabled.
		V _{IH}	0	X	X	Clear Block Lock-Bits Enabled.
			1	X	X	Clear Block Lock-Bits Disabled.
Set Permanent Lock-Bit	≤V _{CCWLK}	X	X	X	X	Set Permanent Lock-Bit Disabled.
	>V _{CCWLK}	V _{IL}	X	X	X	Set Permanent Lock-Bit Disabled.
		V _{IH}	X	X	X	Set Permanent Lock-Bit Enabled.

NOTE:

1. X can be V_{IL} or V_{IH} for RP# and WP#, and "0" or "1" for permanent lock-bit and block lock-bit. See DC Characteristics for V_{CCWLK} voltage.

Table 6. Status Register Definition

WSMS	BESS	ECBLBS	WBWSLBS	VCCWS	WBWSS	DPS	R
7	6	5	4	3	2	1	0
<p>SR.7 = WRITE STATE MACHINE STATUS (WSMS) 1 = Ready 0 = Busy</p> <p>SR.6 = BLOCK ERASE SUSPEND STATUS (BESS) 1 = Block Erase Suspended 0 = Block Erase in Progress/Completed</p> <p>SR.5 = ERASE AND CLEAR BLOCK LOCK-BITS STATUS (ECBLBS) 1 = Error in Block Erase, Full Chip Erase or Clear Block Lock-Bits 0 = Successful Block Erase, Full Chip Erase or Clear Block Lock-Bits</p> <p>SR.4 = WORD/BYTE WRITE AND SET LOCK-BIT STATUS (WBWSLBS) 1 = Error in Word/Byte Write or Set Block/Permanent Lock-Bit 0 = Successful Word/Byte Write or Set Block/Permanent Lock-Bit</p> <p>SR.3 = V_{CCW} STATUS (VCCWS) 1 = V_{CCW} Low Detect, Operation Abort 0 = V_{CCW} OK</p> <p>SR.2 = WORD/BYTE WRITE SUSPEND STATUS (WBWSS) 1 = Word/Byte Write Suspended 0 = Word/Byte Write in Progress/Completed</p> <p>SR.1 = DEVICE PROTECT STATUS (DPS) 1 = Block Lock-Bit, Permanent Lock-Bit and/or WP# Lock Detected, Operation Abort 0 = Unlock</p> <p>SR.0 = RESERVED FOR FUTURE ENHANCEMENTS (R)</p>				<p>NOTES:</p> <p>Check RY/BY# or SR.7 to determine block erase, full chip erase, word/byte write or lock-bit configuration completion. SR.6-0 are invalid while SR.7="0".</p> <p>If both SR.5 and SR.4 are "1"s after a block erase, full chip erase or lock-bit configuration attempt, an improper command sequence was entered.</p> <p>SR.3 does not provide a continuous indication of V_{CCW} level. The WSM interrogates and indicates the V_{CCW} level only after Block Erase, Full Chip Erase, Word/Byte Write or Lock-Bit Configuration command sequences. SR.3 is not guaranteed to reports accurate feedback only when $V_{CCW} \neq V_{CCWH1/2}$.</p> <p>SR.1 does not provide a continuous indication of permanent and block lock-bit and WP# values. The WSM interrogates the permanent lock-bit, block lock-bit and WP# only after Block Erase, Full Chip Erase, Word/Byte Write or Lock-Bit Configuration command sequences. It informs the system, depending on the attempted operation, if the block lock-bit is set, permanent lock-bit is set and/or WP# is V_{IL}. Reading the block lock and permanent lock configuration codes after writing the Read Identifier Codes command indicates permanent and block lock-bit status.</p> <p>SR.0 is reserved for future use and should be masked out when polling the status register.</p>			

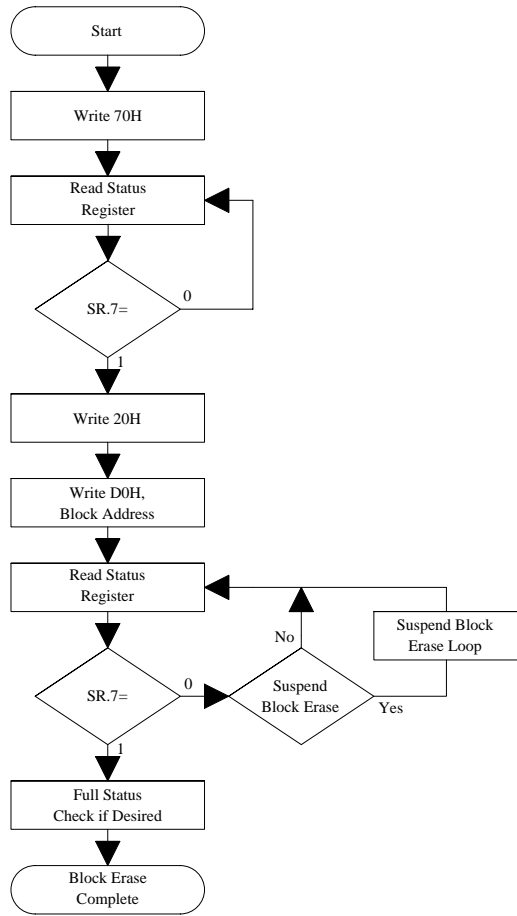

Bus Operation	Command	Comments
Write	Read Status Register	Data=70H Addr=X
Read		Status Register Data
Standby		Check SR.7 1=WSM Ready 0=WSM Busy
Write	Erase Setup	Data=20H Addr=X
Write	Erase Confirm	Data=D0H Addr=Within Block to be Erased
Read		Status Register Data
Standby		Check SR.7 1=WSM Ready 0=WSM Busy

Repeat for subsequent block erasures.
Full status check can be done after each block erase or after a sequence of block erasures.
Write FFH after the last operation to place device in read array mode.

FULL STATUS CHECK PROCEDURE

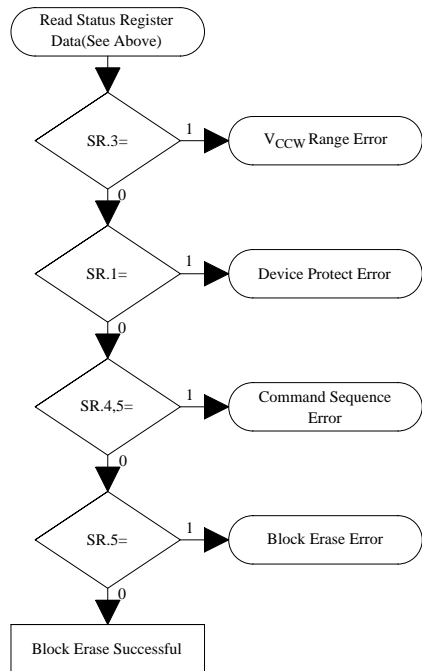

Bus Operation	Command	Comments
Standby		Check SR.3 1=V _{CCW} Error Detect
Standby		Check SR.1 1=Device Protect Detect
Standby		Check SR.4,5 Both 1=Command Sequence Error
Standby		Check SR.5 1=Block Erase Error

SR.5, SR.4, SR.3 and SR.1 are only cleared by the Clear Status Register Command in cases where multiple blocks are erased before full status is checked.
If error is detected, clear the Status Register before attempting retry or other error recovery.

Figure 6. Automated Block Erase Flowchart

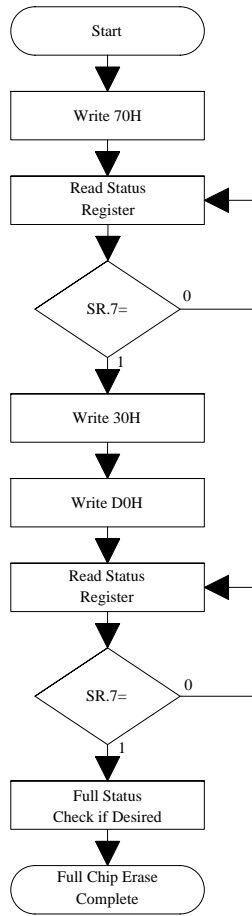

Bus Operation	Command	Comments
Write	Read Status Register	Data=70H Addr=X
Read		Status Register Data
Standby		Check SR.7 1=WSM Ready 0=WSM Busy
Write	Full Chip Erase Setup	Data=30H Addr=X
Write	Full Chip Erase Confirm	Data=D0H Addr=X
Read		Status Register Data
Standby		Check SR.7 1=WSM Ready 0=WSM Busy

Full status check can be done after each full chip erase.
Write FFH after the last operation to place device in read array mode.

FULL STATUS CHECK PROCEDURE

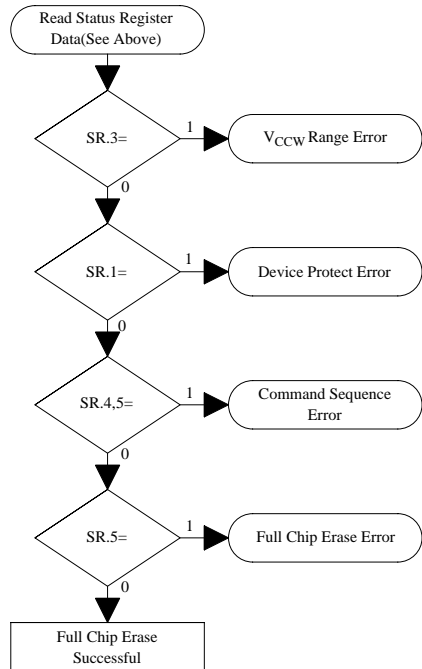

Bus Operation	Command	Comments
Standby		Check SR.3 1=V _{CCW} Error Detect
Standby		Check SR.1 1=Device Protect Detect (All Blocks are locked)
Standby		Check SR.4,5 Both 1=Command Sequence Error
Standby		Check SR.5 1=Full Chip Erase Error

SR.5, SR.4, SR.3 and SR.1 are only cleared by the Clear Status Register Command in cases where multiple blocks are erased before full status is checked.
If error is detected, clear the Status Register before attempting retry or other error recovery.

Figure 7. Automated Full Chip Erase Flowchart

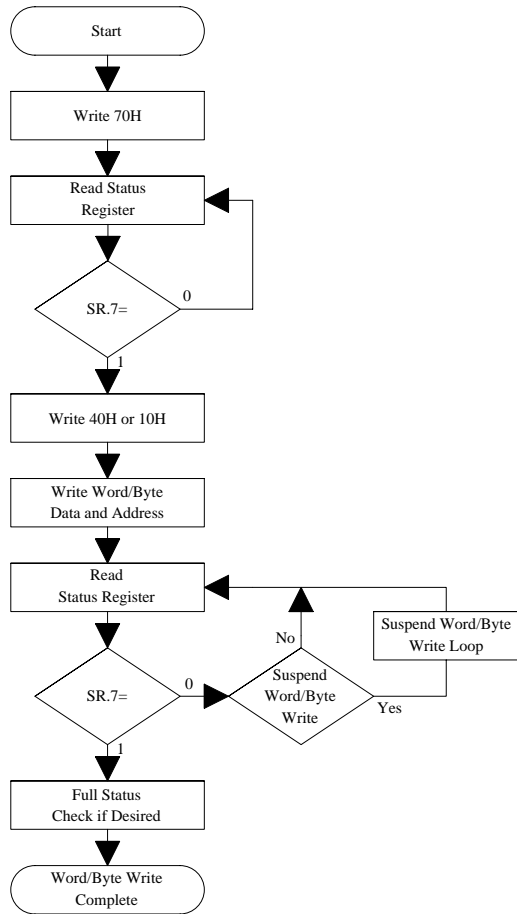

Bus Operation	Command	Comments
Write	Read Status Register	Data=70H Addr=X
Read		Status Register Data
Standby		Check SR.7 1=WSM Ready 0=WSM Busy
Write	Setup Word/Byte Write	Data=40H or 10H Addr=X
Write	Word/Byte Write	Data=Data to Be Written Addr=Location to Be Written
Read		Status Register Data
Standby		Check SR.7 1=WSM Ready 0=WSM Busy

Repeat for subsequent word/byte writes.
 SR full status check can be done after each word/byte write, or after a sequence of word/byte writes.
 Write FFH after the last word/byte write operation to place device in read array mode.

FULL STATUS CHECK PROCEDURE

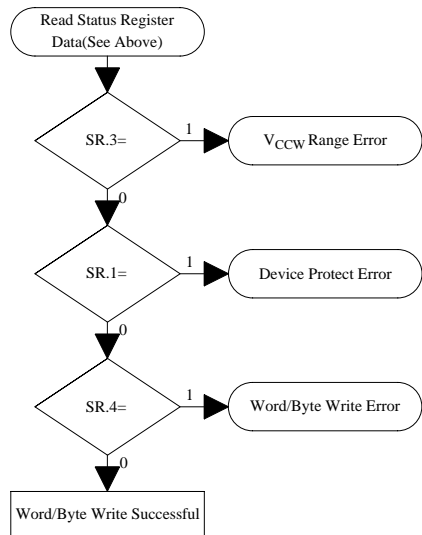

Bus Operation	Command	Comments
Standby		Check SR.3 1=V _{CCW} Error Detect
Standby		Check SR.1 1=Device Protect Detect
Standby		Check SR.4 1=Data Write Error

SR.4, SR.3 and SR.1 are only cleared by the Clear Status Register command in cases where multiple locations are written before full status is checked.
 If error is detected, clear the Status Register before attempting retry or other error recovery.

Figure 8. Automated Word/Byte Write Flowchart

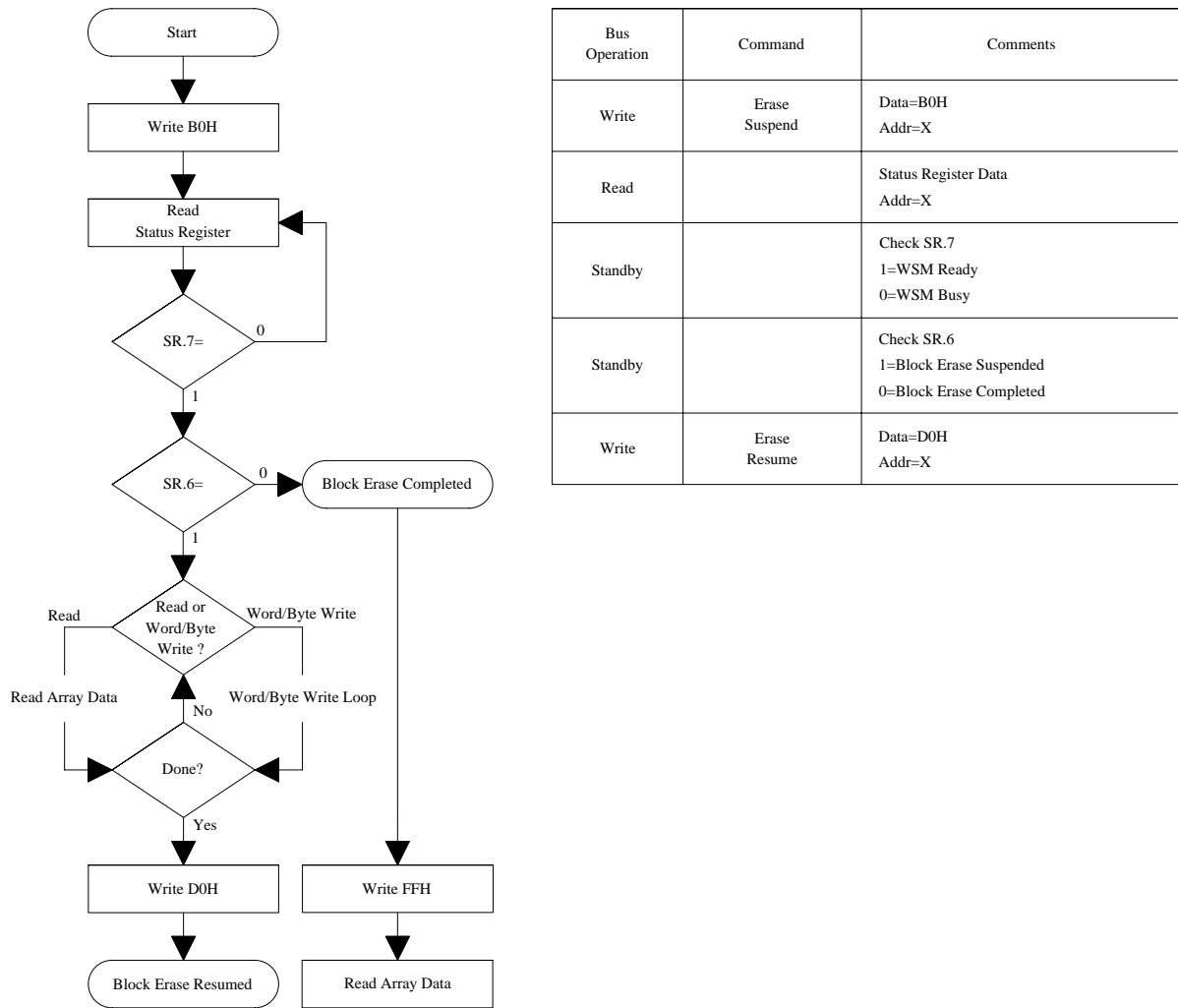
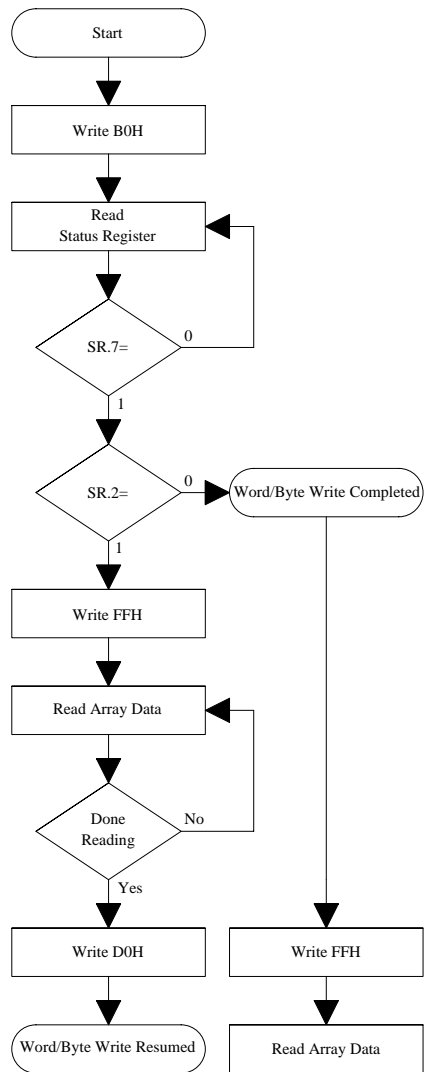
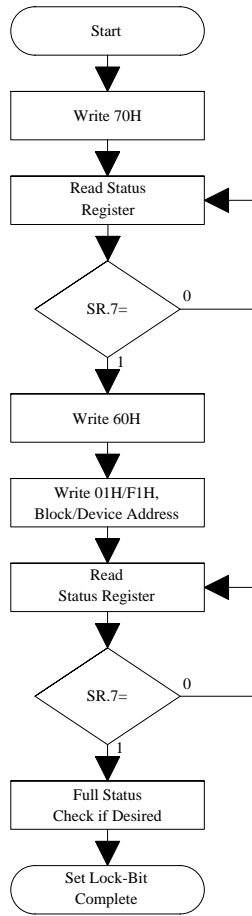

Figure 9. Block Erase Suspend/Resume Flowchart



Bus Operation	Command	Comments
Write	Word/Byte Write Suspend	Data=B0H Addr=X
Read		Status Register Data Addr=X
Standby		Check SR.7 1=WSM Ready 0=WSM Busy
Standby		Check SR.2 1=Word/Byte Write Suspended 0=Word/Byte Write Completed
Write	Read Array	Data=FFH Addr=X
Read		Read Array locations other than that being written.
Write	Word/Byte Write Resume	Data=D0H Addr=X

Figure 10. Word/Byte Write Suspend/Resume Flowchart



Bus Operation	Command	Comments
Write	Read Status Register	Data=70H Addr=X
Read		Status Register Data
Standby		Check SR.7 1=WSM Ready 0=WSM Busy
Write	Set Block/Permanent Lock-Bit Setup	Data=60H Addr=X
Write	Set Block or Permanent Lock-Bit Confirm	Data=01H(Block), F1H(Permanent) Addr=Block Address(Block), Device Address(Permanent)
Read		Status Register Data
Standby		Check SR.7 1=WSM Ready 0=WSM Busy
Repeat for subsequent lock-bit set operations. Full status check can be done after each lock-bit set operation or after a sequence of lock-bit set operations. Write FFH after the last lock-bit set operation to place device in read array mode.		

FULL STATUS CHECK PROCEDURE

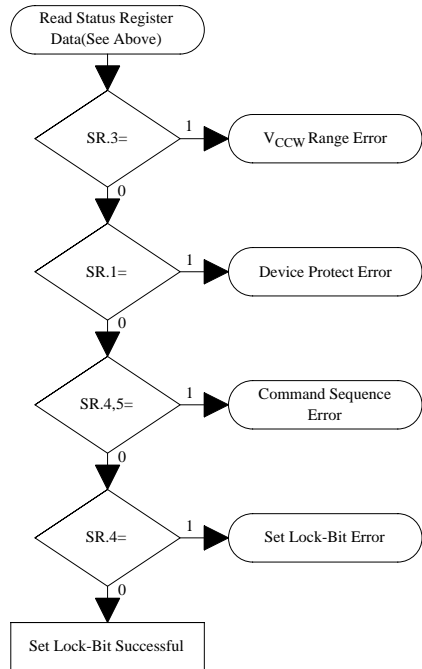

Bus Operation	Command	Comments
Standby		Check SR.3 1=V _{CCW} Error Detect
Standby		Check SR.1 1=Device Protect Detect Permanent Lock-Bit is Set (Set Block Lock-Bit Operation)
Standby		Check SR.4,5 Both 1=Command Sequence Error
Standby		Check SR.4 1=Set Lock-Bit Error
SR.5, SR.4, SR.3 and SR.1 are only cleared by the Clear Status Register command in cases where multiple lock-bits are set before full status is checked. If error is detected, clear the Status Register before attempting retry or other error recovery.		

Figure 11. Set Block and Permanent Lock-Bit Flowchart

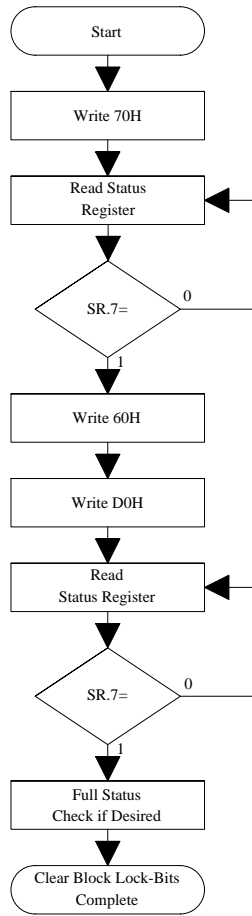

Bus Operation	Command	Comments
Write	Read Status Register	Data=70H Addr=X
Read		Status Register Data
Standby		Check SR.7 1=WSM Ready 0=WSM Busy
Write	Clear Block Lock-Bits Setup	Data=60H Addr=X
Write	Clear Block Lock-Bits Confirm	Data=D0H Addr=X
Read		Status Register Data
Standby		Check SR.7 1=WSM Ready 0=WSM Busy

Write FFH after the Clear Block Lock-Bits operation to place device in read array mode.

FULL STATUS CHECK PROCEDURE

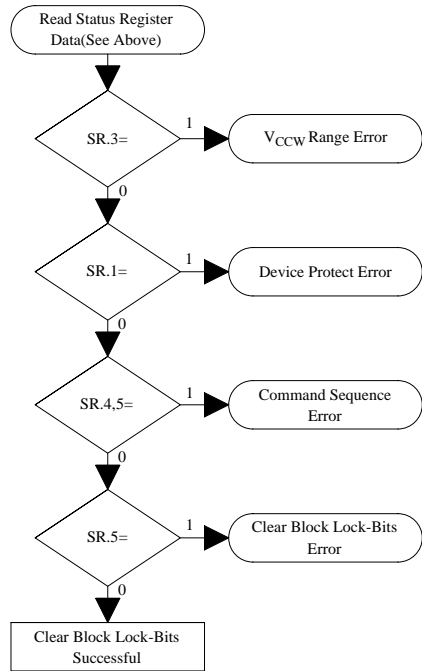

Bus Operation	Command	Comments
Standby		Check SR.3 1=V _{CCW} Error Detect
Standby		Check SR.1 1=Device Protect Detect Permanent Lock-Bit is Set
Standby		Check SR.4,5 Both 1=Command Sequence Error
Standby		Check SR.5 1=Clear Block Lock-Bits Error

SR.5, SR.4, SR.3 and SR.1 are only cleared by the Clear Status Register command. If error is detected, clear the Status Register before attempting retry or other error recovery.

Figure 12. Clear Block Lock-Bits Flowchart

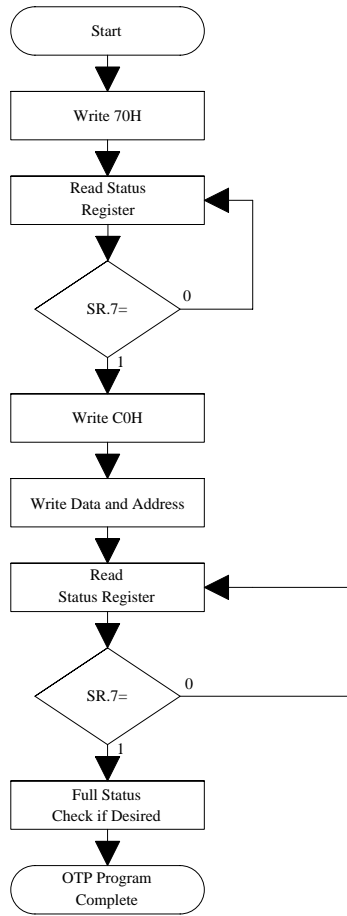

Bus Operation	Command	Comments
Write	Read Status Register	Data=70H Addr=X
Read		Status Register Data
Standby		Check SR.7 1=WSM Ready 0=WSM Busy
Write	Setup OTP Program	Data=C0H Addr=X
Write	OTP Program	Data=Data to Be Written Addr=Location to Be Written
Read		Status Register Data
Standby		Check SR.7 1=WSM Ready 0=WSM Busy

Repeat for subsequent OTP programs.
 SR full status check can be done after each OTP program, or after a sequence of OTP programs.
 Write FFH after the last OTP program operation to place device in read array mode.

FULL STATUS CHECK PROCEDURE

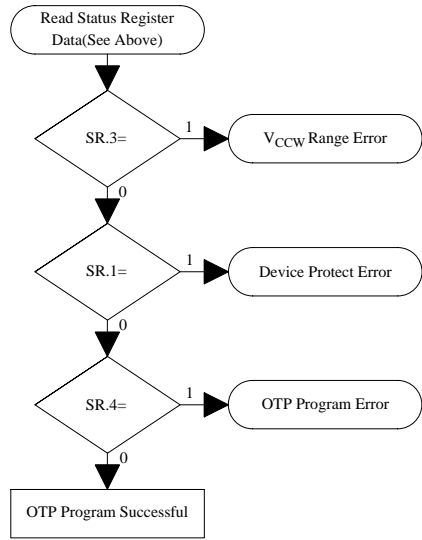

Bus Operation	Command	Comments
Standby		Check SR.3 1=V _{CCW} Error Detect
Standby		Check SR.1 1=Device Protect Detect
Standby		Check SR.4 1=Data Write Error

SR.4, SR.3 and SR.1 are only cleared by the Clear Status Register command in cases where multiple locations are written before full status is checked.
 If error is detected, clear the Status Register before attempting retry or other error recovery.

Figure 13. Automated OTP Program Flowchart

5 DESIGN CONSIDERATIONS

5.1 Three-Line Output Control

The device will often be used in large memory arrays. SHARP provides three control inputs to accommodate multiple memory connections. Three-line control provides for:

- a. Lowest possible memory power dissipation.
- b. Complete assurance that data bus contention will not occur.

To use these control inputs efficiently, an address decoder should enable CE# while OE# should be connected to all memory devices and the system's READ# control line. This assures that only selected memory devices have active outputs while deselected memory devices are in standby mode. RP# should be connected to the system POWERGOOD signal to prevent unintended writes during system power transitions. POWERGOOD should also toggle during system reset.

5.2 RY/BY# and WSM Polling

RY/BY# is an open drain output that should be connected to V_{CC} by a pull up resistor to provides a hardware method of detecting block erase, full chip erase, word/byte write and lock-bit configuration completion. It transitions low after block erase, full chip erase, word/byte write or lock-bit configuration commands and returns to V_{OH} (while RY/BY# is pull up) when the WSM has finished executing the internal algorithm.

RY/BY# can be connected to an interrupt input of the system CPU or controller. It is active at all times. RY/BY# is also High Z when the device is in block erase suspend (with word/byte write inactive), word/byte write suspend or reset modes.

5.3 Power Supply Decoupling

Flash memory power switching characteristics require careful device decoupling. System designers are interested in three supply current issues; standby current levels, active current levels and transient peaks produced by falling and rising edges of CE# and OE#. Transient current magnitudes depend on the device outputs' capacitive and inductive loading. Two-line control and proper decoupling capacitor selection will suppress transient voltage peaks. Each device should have a 0.1 μ F ceramic capacitor connected between its V_{CC} and GND and between its V_{CCW} and GND. These high-frequency, low inductance capacitors should be placed as close as possible to package leads. Additionally, for every eight devices, a 4.7 μ F electrolytic capacitor should be placed at the array's power supply connection between V_{CC} and GND. The bulk capacitor will overcome voltage slumps caused by PC board trace inductance.

5.4 V_{CCW} Trace on Printed Circuit Boards

Updating flash memories that reside in the target system requires that the printed circuit board designer pay attention to the V_{CCW} Power supply trace. The V_{CCW} pin supplies the memory cell current for word/byte writing and block erasing. Use similar trace widths and layout considerations given to the V_{CC} power bus. Adequate V_{CCW} supply traces and decoupling will decrease V_{CCW} voltage spikes and overshoots.

5.5 V_{CC} , V_{CCW} , RP# Transitions

Block erase, full chip erase, word/byte write and lock-bit configuration are not guaranteed if V_{CCW} falls outside of a valid $V_{CCWH1/2}$ range, V_{CC} falls outside of a valid 2.7V-3.6V range, or $RP\# \neq V_{IH}$. If V_{CCW} error is detected, status register bit SR.3 is set to "1" along with SR.4 or SR.5, depending on the attempted operation. If RP# transitions to V_{IL} during block erase, full chip erase, word/byte write or lock-bit configuration, RY/BY# will remain low until the reset operation is complete. Then, the operation will abort and the device will enter reset mode. The aborted operation may leave data partially altered. Therefore, the command sequence must be repeated after normal operation is restored. Device power-off or RP# transitions to V_{IL} clear the status register.

The CUI latches commands issued by system software and is not altered by V_{CCW} or CE# transitions or WSM actions. Its state is read array mode upon power-up, after exit from reset mode or after V_{CC} transitions below V_{LKO} .

5.6 Power-Up/Down Protection

The device is designed to offer protection against accidental block erase, full chip erase, word/byte write or lock-bit configuration during power transitions. Upon power-up, the device is indifferent as to which power supply (V_{CCW} or V_{CC}) powers-up first. Internal circuitry resets the CUI to read array mode at power-up.

A system designer must guard against spurious writes for V_{CC} voltages above V_{LKO} when V_{CCW} is active. Since both $WE\#$ and $CE\#$ must be low for a command write, driving either to V_{IH} will inhibit writes. The CUI's two-step command sequence architecture provides added level of protection against data alteration.

In-system block lock and unlock capability prevents inadvertent data alteration. The device is disabled while $RP\#=V_{IL}$ regardless of its control inputs state.

5.7 Power Dissipation

When designing portable systems, designers must consider battery power consumption not only during device operation, but also for data retention during system idle time. Flash memory's nonvolatility increases usable battery life because data is retained when system power is removed.

5.8 Data Protection Method

Noises having a level exceeding the limit specified in the specification may be generated under specific operating conditions on some systems. Such noises, when induced onto $WE\#$ signal or power supply, may be interpreted as false commands, causing undesired memory updating. To protect the data stored in the flash memory against unwanted overwriting, systems operating with the flash memory should have the following write protect designs, as appropriate:

1) Protecting data in specific block

When a lock bit is set, the corresponding block (includes the 2 boot blocks) is protected against overwriting. By setting a $WP\#$ to low, only the 2 boot blocks can be protected against overwriting. By using this feature, the flash memory space can be divided into the program section (locked section) and data section (unlocked section). The permanent lock bit can be used to prevent false block bit setting. For further information on setting/resetting lock-bit, refer to the specification. (See chapter 4.10 and 4.11.)

2) Data protection through V_{CCW}

When the level of V_{CCW} is lower than V_{CCWLK} (lockout voltage), write operation on the flash memory is disabled. All blocks are locked and the data in the blocks are completely write protected. For the lockout voltage, refer to the specification. (See chapter 6.2.3.)

3) Data protection through $RP\#$

When the $RP\#$ is kept low during read mode, the flash memory will be reset mode, then write protecting all blocks. When the $RP\#$ is kept low during power up and power down sequence such as voltage transition, write operation on the flash memory is disabled, write protecting all blocks. For the details of $RP\#$ control, refer to the specification. (See chapter 5.6 and 6.2.7.)

6 ELECTRICAL SPECIFICATIONS

6.1 Absolute Maximum Ratings*

Operating Temperature

During Read, Block Erase,
Full Chip Erase, Word/Byte Write
and Lock-Bit Configuration-40°C to +85°C⁽¹⁾

Storage Temperature

During under Bias -40°C to +85°C
During non Bias -65°C to +125°C

Voltage On Any Pin

(except V_{CC} and V_{CCW}) -0.5V to V_{CC}+0.5V⁽²⁾

V_{CC} Supply Voltage..... -0.2V to +4.6V⁽²⁾

V_{CCW} Supply Voltage.....-0.2V to +13.0V^(2,3)

Output Short Circuit Current.....100mA⁽⁴⁾

**WARNING: Stressing the device beyond the "Absolute Maximum Ratings" may cause permanent damage. These are stress ratings only. Operation beyond the "Operating Conditions" is not recommended and extended exposure beyond the "Operating Conditions" may affect device reliability.*

NOTES:

1. Operating temperature is for extended temperature product defined by this specification.
2. All specified voltages are with respect to GND. Minimum DC voltage is -0.5V on input/output pins and -0.2V on V_{CC} and V_{CCW} pins. During transitions, this level may undershoot to -2.0V for periods <20ns. Maximum DC voltage on input/output pins are V_{CC}+0.5V which, during transitions, may overshoot to V_{CC}+2.0V for periods <20ns.
3. Maximum DC voltage on V_{CCW} may overshoot to +13.0V for periods <20ns. Applying 12V±0.3V to V_{CCW} during erase/write can only be done for a maximum of 1000 cycles on each block. V_{CCW} may be connected to 12V±0.3V for a total of 80 hours maximum.
4. Output shorted for no more than one second. No more than one output shorted at a time.

6.2 Operating Conditions

Temperature and V_{CC} Operating Conditions

Symbol	Parameter	Min.	Max.	Unit	Test Condition
T _A	Operating Temperature	-40	+85	°C	Ambient Temperature
V _{CC}	V _{CC} Supply Voltage (2.7V-3.6V)	2.7	3.6	V	

6.2.1 Capacitance⁽¹⁾

T_A=+25°C, f=1MHz

Symbol	Parameter	Typ.	Max.	Unit	Condition
C _{IN}	Input Capacitance	7	10	pF	V _{IN} =0.0V
C _{OUT}	Output Capacitance	9	12	pF	V _{OUT} =0.0V

NOTE:

1. Sampled, not 100% tested.

6.2.2 AC Input/Output Test Conditions

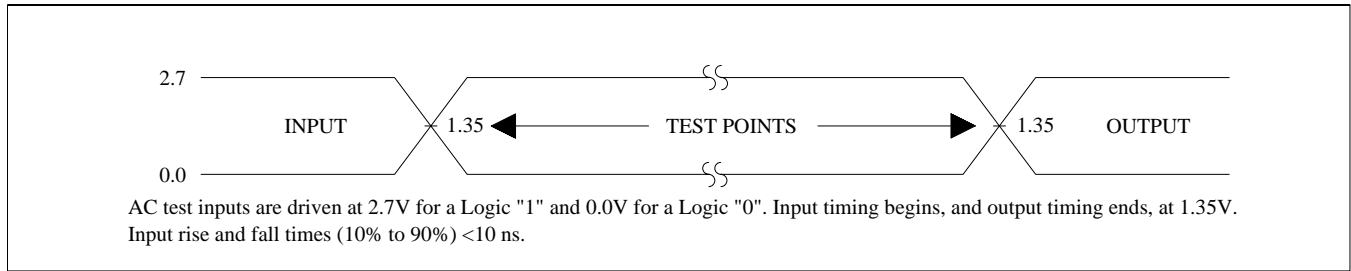

Figure 14. Transient Input/Output Reference Waveform for $V_{CC}=2.7V-3.6V$

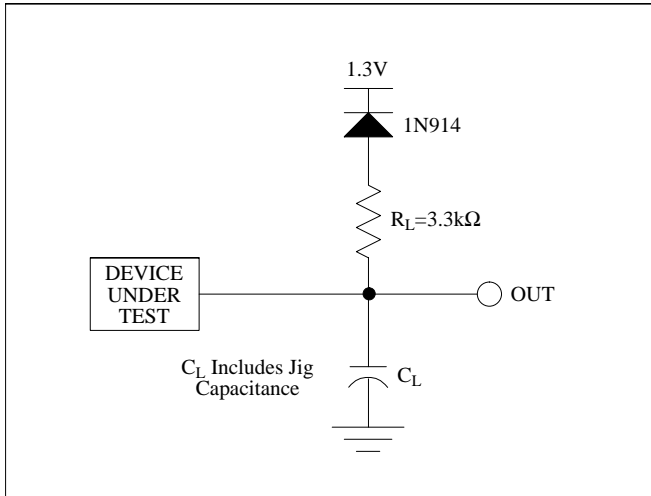

Figure 15. Transient Equivalent Testing Load Circuit

Test Configuration Capacitance Loading Value

Test Configuration	C_L (pF)
$V_{CC}=2.7V-3.6V$	50

6.2.3 DC Characteristics

DC Characteristics

Sym.	Parameter	Notes	V _{CC} =2.7V-3.6V		Unit	Test Conditions
			Typ.	Max.		
I _{LI}	Input Load Current	1		±0.5	μA	V _{CC} =V _{CC} Max. V _{IN} =V _{CC} or GND
I _{LO}	Output Leakage Current	1		±0.5	μA	V _{CC} =V _{CC} Max. V _{OUT} =V _{CC} or GND
I _{CCS}	V _{CC} Standby Current	1,3,6	2	15	μA	CMOS Level Inputs V _{CC} =V _{CC} Max. CE#=RP#=V _{CC} ±0.2V
			0.2	2	mA	TTL Level Inputs V _{CC} =V _{CC} Max. CE#=RP#=V _{IH}
I _{CCAS}	V _{CC} Auto Power-Save Current	1,5,6	2	15	μA	CMOS Level Inputs V _{CC} =V _{CC} Max. CE#=GND±0.2V
I _{CCD}	V _{CC} Reset Power-Down Current	1	2	15	μA	RP#=GND±0.2V I _{OUT} (RY/BY#)=0mA
I _{CCR}	V _{CC} Read Current	1,6	15	25	mA	CMOS Level Inputs V _{CC} =V _{CC} Max., CE#=GND f=5MHz, I _{OUT} =0mA
				30	mA	TTL Level Inputs V _{CC} =V _{CC} Max., CE#=GND f=5MHz, I _{OUT} =0mA
I _{CCW}	V _{CCW} Word/Byte Write or Set Lock-Bit Current	1,7	5	17	mA	V _{CCW} =2.7V-3.6V
			5	12	mA	V _{CCW} =11.7V-12.3V
I _{CCCE}	V _{CC} Block Erase, Full Chip Erase or Clear Block Lock-Bits Current	1,7	4	17	mA	V _{CCW} =2.7V-3.6V
			4	12	mA	V _{CCW} =11.7V-12.3V
I _{CCWS} I _{CCES}	V _{CC} Word/Byte Write or Block Erase Suspend Current	1,2	1	6	mA	CE#=V _{IH}
I _{CCWS} I _{CCWR}	V _{CCW} Standby or Read Current	1	±2	±15	μA	V _{CCW} ≤V _{CC}
			10	200	μA	V _{CCW} >V _{CC}
I _{CCWAS}	V _{CCW} Auto Power-Save Current	1,5,6	0.1	5	μA	CMOS Level Inputs V _{CC} =V _{CC} Max. CE#=GND±0.2V
I _{CCWD}	V _{CCW} Reset Power-Down Current	1	0.1	5	μA	RP#=GND±0.2V
I _{CCWW}	V _{CCW} Word/Byte Write or Set Lock-Bit Current	1,7	12	40	mA	V _{CCW} =2.7V-3.6V
				30	mA	V _{CCW} =11.7V-12.3V
I _{CCWE}	V _{CCW} Block Erase, Full Chip Erase or Clear Block Lock-Bits Current	1,7	8	25	mA	V _{CCW} =2.7V-3.6V
				20	mA	V _{CCW} =11.7V-12.3V
I _{CCWWS} I _{CCWES}	V _{CCW} Word/Byte Write or Block Erase Suspend Current	1	10	200	μA	V _{CCW} =V _{CCWH} /2

DC Characteristics (Continued)

Sym.	Parameter	Notes	V _{CC} =2.7V-3.6V		Unit	Test Conditions
			Min.	Max.		
V _{IL}	Input Low Voltage	7	-0.5	0.8	V	
V _{IH}	Input High Voltage	7	2.0	V _{CC} +0.5	V	
V _{OL}	Output Low Voltage	3,7		0.4	V	V _{CC} =V _{CC} Min. I _{OL} =2.0mA
V _{OH1}	Output High Voltage (TTL)	7	2.4		V	V _{CC} =V _{CC} Min. I _{OH} =-2.0mA
V _{OH2}	Output High Voltage (CMOS)	7	0.85		V	V _{CC} =V _{CC} Min. I _{OH} =-2.5mA
			V _{CC} -0.4		V	V _{CC} =V _{CC} Min. I _{OH} =-100μA
V _{CCWLK}	V _{CCW} Lockout during Normal Operations	4,7		1.0	V	
V _{CCWH1}	V _{CCW} during Block Erase, Full Chip Erase, Word/Byte Write or Lock-Bit Configuration Operations		2.7	3.6	V	
V _{CCWH2}	V _{CCW} during Block Erase, Full Chip Erase, Word/Byte Write or Lock-Bit Configuration Operations	8	11.7	12.3	V	
V _{LKO}	V _{CC} Lockout Voltage		2.0		V	

NOTES:

- All currents are in RMS unless otherwise noted. Typical values at nominal V_{CC} voltage and T_A=+25°C.
- I_{CCWS} and I_{CCES} are specified with the device de-selected. If read or word/byte written while in erase suspend mode, the device's current draw is the sum of I_{CCWS} or I_{CCES} and I_{CCR} or I_{CCW}, respectively.
- Includes RY/BY#.
- Block erases, full chip erase, word/byte writes and lock-bit configurations are inhibited when V_{CCW} ≤ V_{CCWLK}, and not guaranteed in the range between V_{CCWLK}(max.) and V_{CCWH1}(min.), between V_{CCWH1}(max.) and V_{CCWH2}(min.) and above V_{CCWH2}(max.).
- The Automatic Power Savings (APS) feature is placed automatically power save mode that addresses not switching more than 300ns while read mode.
- About all of pin except describe Test Conditions, CMOS level inputs are either V_{CC}±0.2V or GND±0.2V, TTL level inputs are either V_{IL} or V_{IH}.
- Sampled, not 100% tested.
- Applying 12V±0.3V to V_{CCW} during erase/write can only be done for a maximum of 1000 cycles on each block. V_{CCW} may be connected to 12V±0.3V for a total of 80 hours maximum.

6.2.4 AC Characteristics - Read-Only Operations⁽¹⁾
 $V_{CC}=2.7V-3.6V, T_A=-40^{\circ}C \text{ to } +85^{\circ}C$

Sym.	Parameter	Notes	Min.	Max.	Unit
t_{AVAV}	Read Cycle Time		90		ns
t_{AVQV}	Address to Output Delay			90	ns
t_{ELQV}	CE# to Output Delay	2		90	ns
t_{PHQV}	RP# High to Output Delay			600	ns
t_{GLQV}	OE# to Output Delay	2		50	ns
t_{ELOX}	CE# to Output in Low Z	3	0		ns
t_{EHQZ}	CE# High to Output in High Z	3		55	ns
t_{GLQX}	OE# to Output in Low Z	3	0		ns
t_{GHQZ}	OE# High to Output in High Z	3		20	ns
t_{OH}	Output Hold from Address, CE# or OE# Change, Whichever Occurs First	3	0		ns
t_{FVQV}	BYTE# to Output Delay	3		90	ns
t_{FLQZ}	BYTE# Low to Output in High Z	3		30	ns
t_{ELFV}	CE# to BYTE# High or Low	3,4		5	ns

NOTES:

1. See AC Input/Output Reference Waveform for maximum allowable input slew rate.
2. OE# may be delayed up to $t_{ELQV}-t_{GLQV}$ after the falling edge of CE# without impact on t_{ELQV} .
3. Sampled, not 100% tested.
4. If BYTE# transfer during reading cycle, exist the regulations separately.

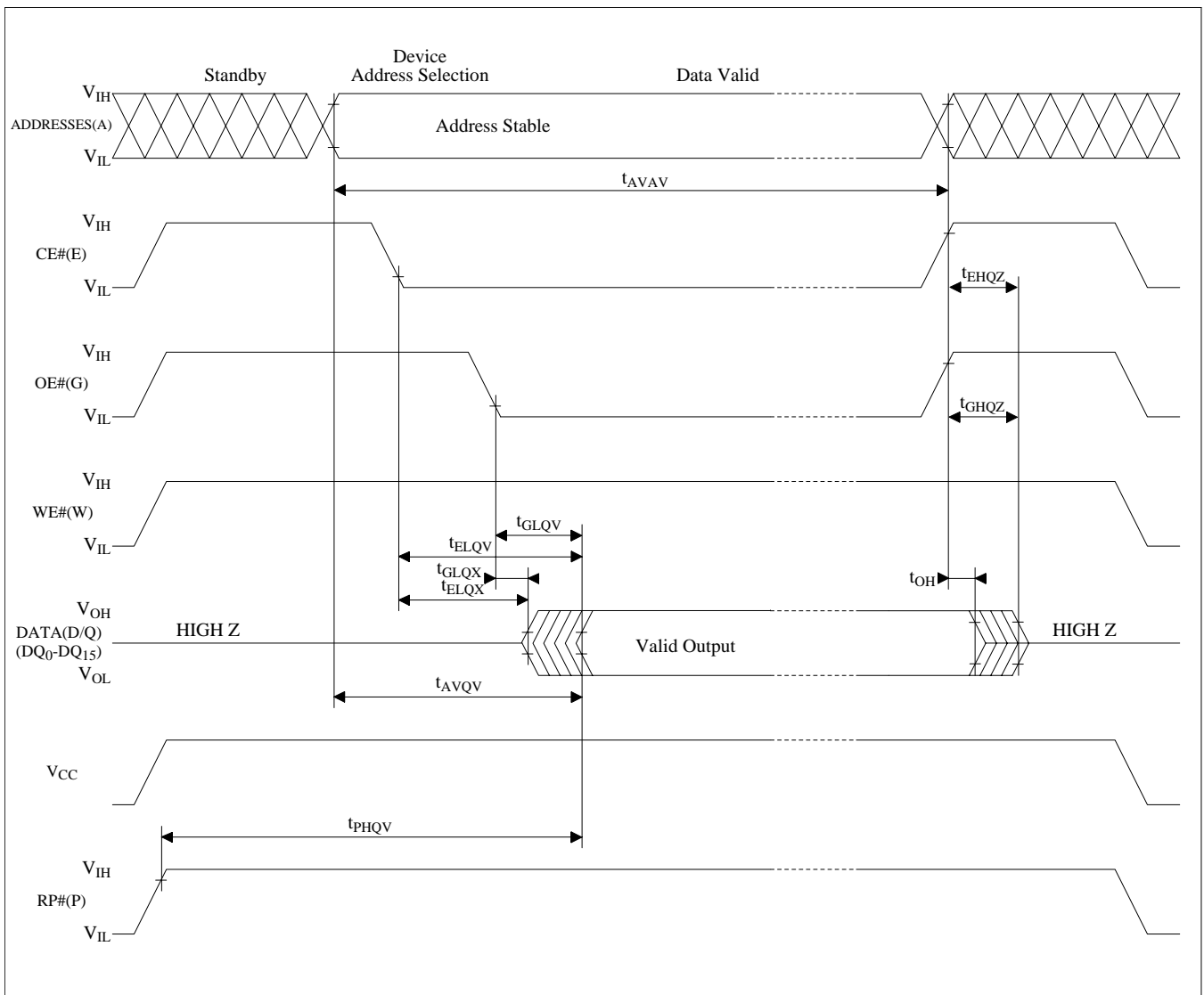

Figure 16. AC Waveform for Read Operations

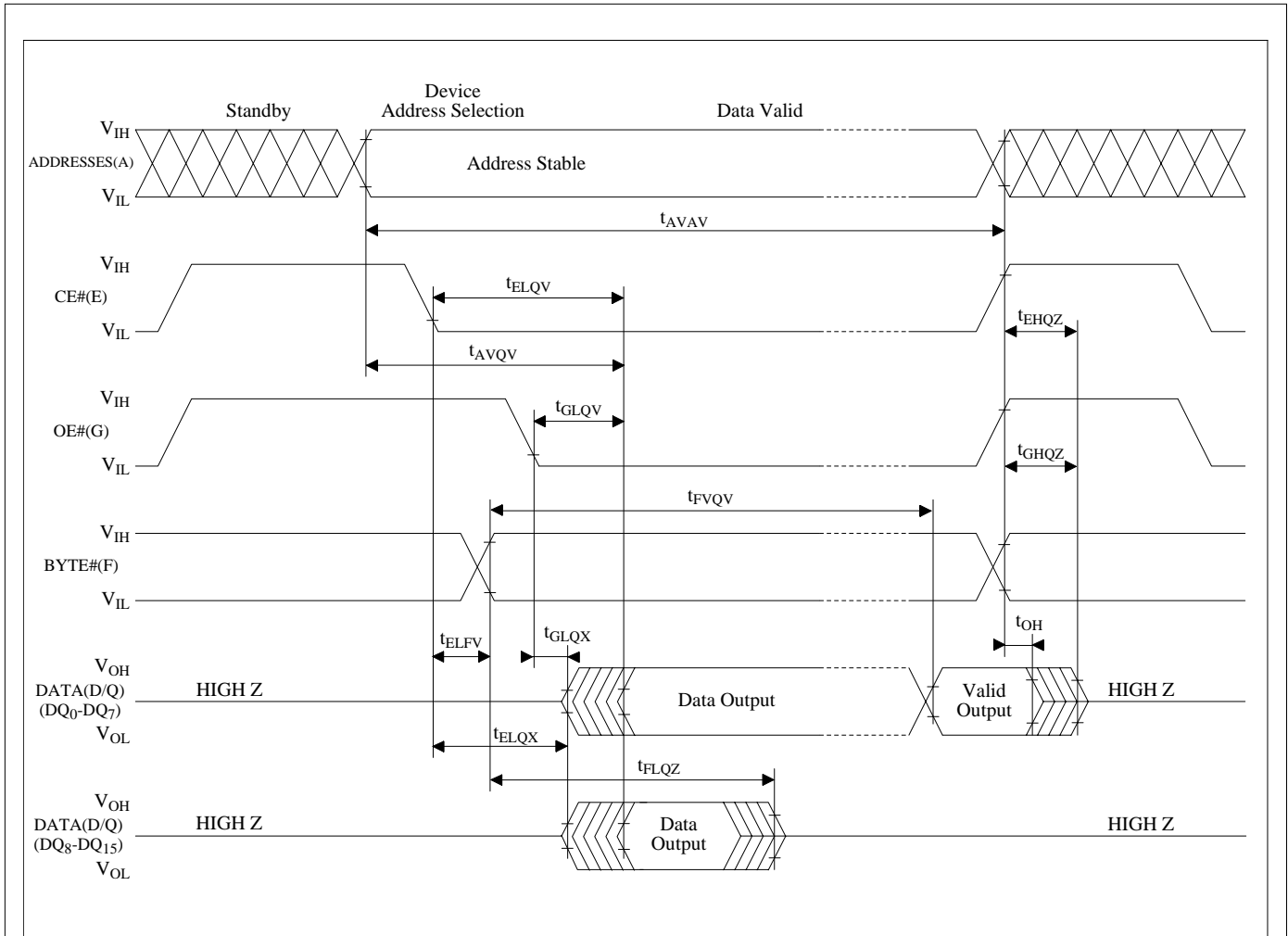

Figure 17. BYTE# timing Waveform

6.2.5 AC Characteristics - Write Operations⁽¹⁾
 $V_{CC}=2.7V-3.6V, T_A=-40^{\circ}C \text{ to } +85^{\circ}C$

Sym.	Parameter	Notes	Min.	Max.	Unit
t_{AVAV}	Write Cycle Time		90		ns
t_{PHWL}	RP# High Recovery to WE# Going Low	2	1		μs
t_{ELWL}	CE# Setup to WE# Going Low		10		ns
t_{WLWH}	WE# Pulse Width		50		ns
t_{SHWH}	WP# V_{IH} Setup to WE# Going High	2	100		ns
t_{VPWH}	V_{CCW} Setup to WE# Going High	2	100		ns
t_{AVWH}	Address Setup to WE# Going High	3	50		ns
t_{DVWH}	Data Setup to WE# Going High	3	50		ns
t_{WHDX}	Data Hold from WE# High		0		ns
t_{WHAX}	Address Hold from WE# High		0		ns
t_{WHEH}	CE# Hold from WE# High		10		ns
t_{WHWL}	WE# Pulse Width High		30		ns
t_{WHRL}	WE# High to RY/BY# Going Low or SR.7 Going "0"			100	ns
t_{WHGL}	Write Recovery before Read		0		ns
t_{QVVL}	V_{CCW} Hold from Valid SRD, RY/BY# High Z	2,4	0		ns
t_{QVSL}	WP# V_{IH} Hold from Valid SRD, RY/BY# High Z	2,4	0		ns
t_{FVWH}	BYTE# Setup to WE# Going High	5	50		ns
t_{WHFV}	BYTE# Hold from WE# High	5	90		ns

NOTES:

1. Read timing characteristics during block erase, full chip erase, word/byte write and lock-bit configuration operations are the same as during read-only operations. Refer to AC Characteristics for read-only operations.
2. Sampled, not 100% tested.
3. Refer to Table 4 for valid A_{IN} and D_{IN} for block erase, full chip erase, word/byte write or lock-bit configuration.
4. V_{CCW} should be held at $V_{CCWH1/2}$ until determination of block erase, full chip erase, word/byte write or lock-bit configuration success (SR.1/3/4/5=0).
5. If BYTE# switch during reading cycle, exist the regulations separately.

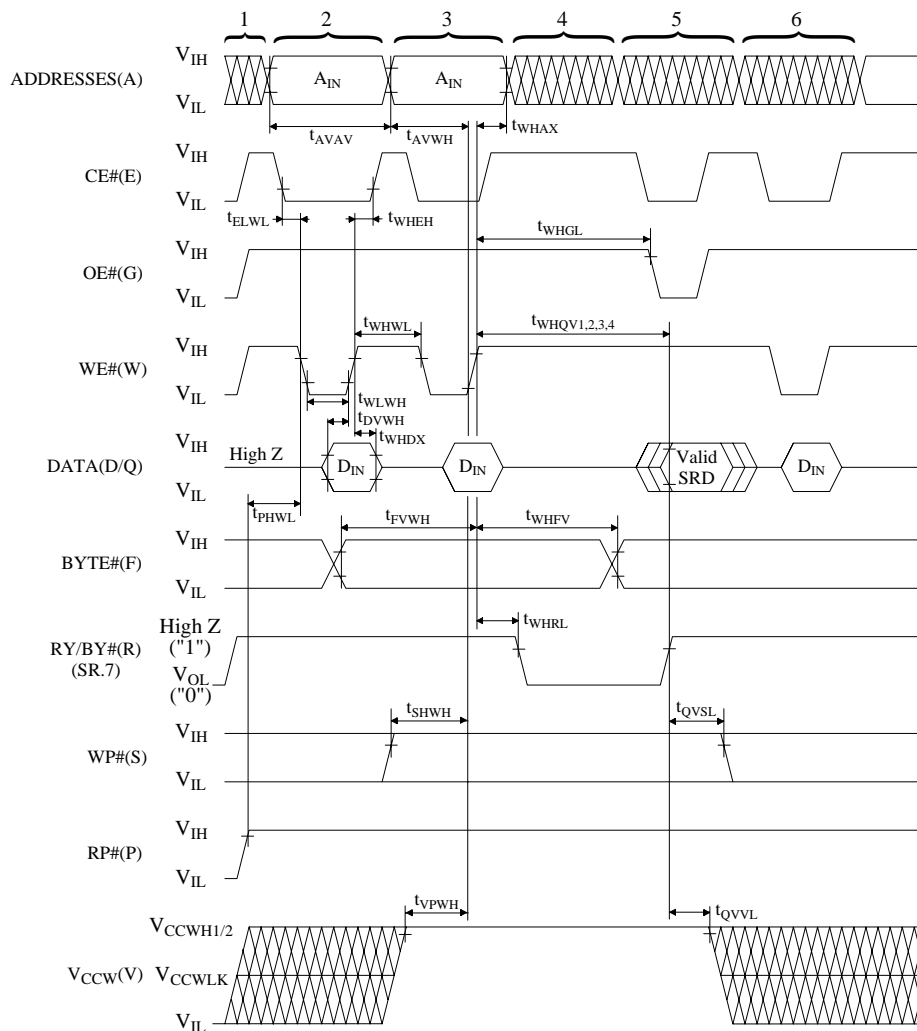

NOTES:

1. V_{CC} power-up and standby.
2. Write each setup command.
3. Write each confirm command or valid address and data.
4. Automated erase or program delay.
5. Read status register data.
6. Write Read Array command.

Figure 18. AC Waveform for WE#-Controlled Write Operations

6.2.6 Alternative CE#-Controlled Writes⁽¹⁾
 $V_{CC}=2.7V-3.6V, T_A=-40^{\circ}C \text{ to } +85^{\circ}C$

Sym.	Parameter	Notes	Min.	Max.	Unit
t _{AVAV}	Write Cycle Time		90		ns
t _{PHEL}	RP# High Recovery to CE# Going Low	2	1		μs
t _{WLEL}	WE# Setup to CE# Going Low		0		ns
t _{ELEH}	CE# Pulse Width		50		ns
t _{SHEH}	WP#V _{IH} Setup to CE# Going High	2	100		ns
t _{VPEH}	V _{CCW} Setup to CE# Going High	2	100		ns
t _{AVEH}	Address Setup to CE# Going High	3	50		ns
t _{DVEH}	Data Setup to CE# Going High	3	50		ns
t _{EHDX}	Data Hold from CE# High		0		ns
t _{EHAX}	Address Hold from CE# High		0		ns
t _{EHWH}	WE# Hold from CE# High		0		ns
t _{EHEL}	CE# Pulse Width High		30		ns
t _{EHRL}	CE# High to RY/BY# Going Low or SR.7 Going "0"			100	ns
t _{EHGL}	Write Recovery before Read		0		ns
t _{QVVL}	V _{CCW} Hold from Valid SRD, RY/BY# High Z	2,4	0		ns
t _{QVSL}	WP# V _{IH} Hold from Valid SRD, RY/BY# High Z	2,4	0		ns
t _{FVEH}	BYTE# Setup to CE# Going High	5	50		ns
t _{EHFV}	BYTE# Hold from CE# High	5	90		ns

NOTES:

1. In systems where CE# defines the write pulse width (within a longer WE# timing waveform), all setup, hold, and inactive WE# times should be measured relative to the CE# waveform.
2. Sampled, not 100% tested.
3. Refer to Table 4 for valid A_{IN} and D_{IN} for block erase, full chip erase, word/byte write or lock-bit configuration.
4. V_{CCW} should be held at V_{CCWH1/2} until determination of block erase, full chip erase, word/byte write or lock-bit configuration success (SR.1/3/4/5=0).
5. If BYTE# switch during reading cycle, exist the regulations separately.

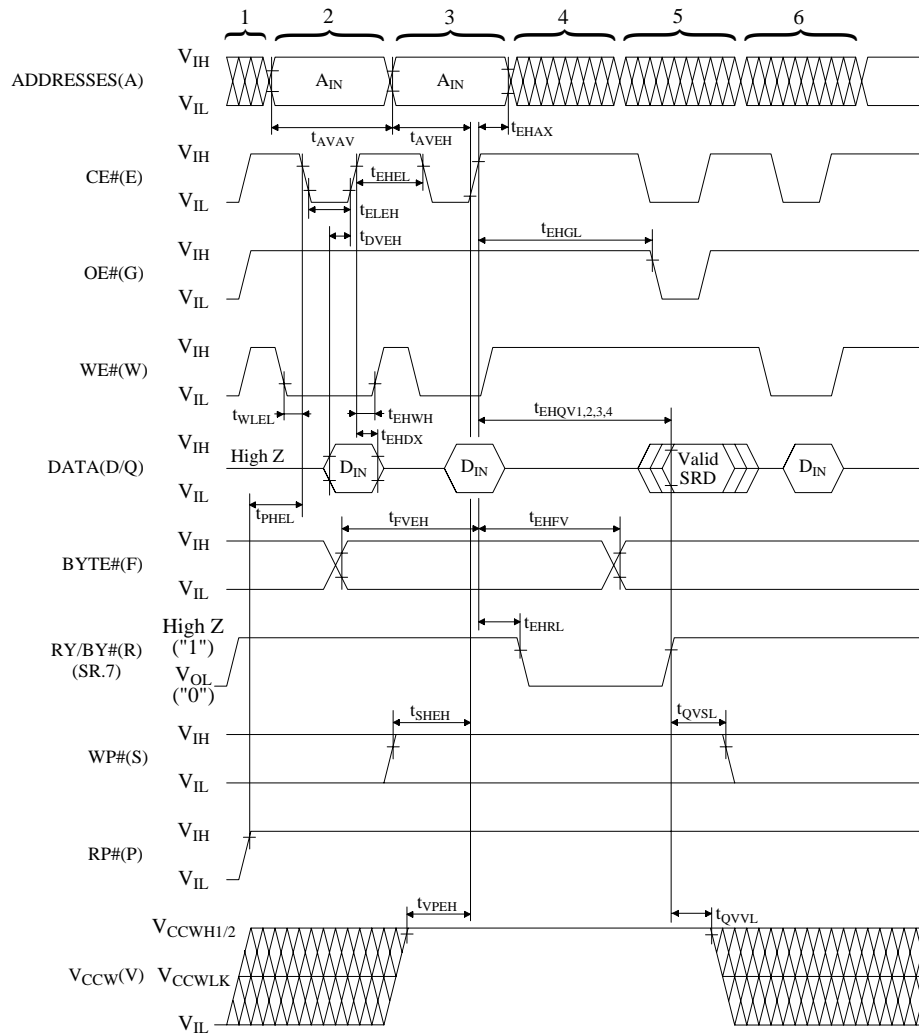

NOTES:

1. V_{CC} power-up and standby.
2. Write each setup command.
3. Write each confirm command or valid address and data.
4. Automated erase or program delay.
5. Read status register data.
6. Write Read Array command.

Figure 19. AC Waveform for CE#-Controlled Write Operations

6.2.7 Reset Operations

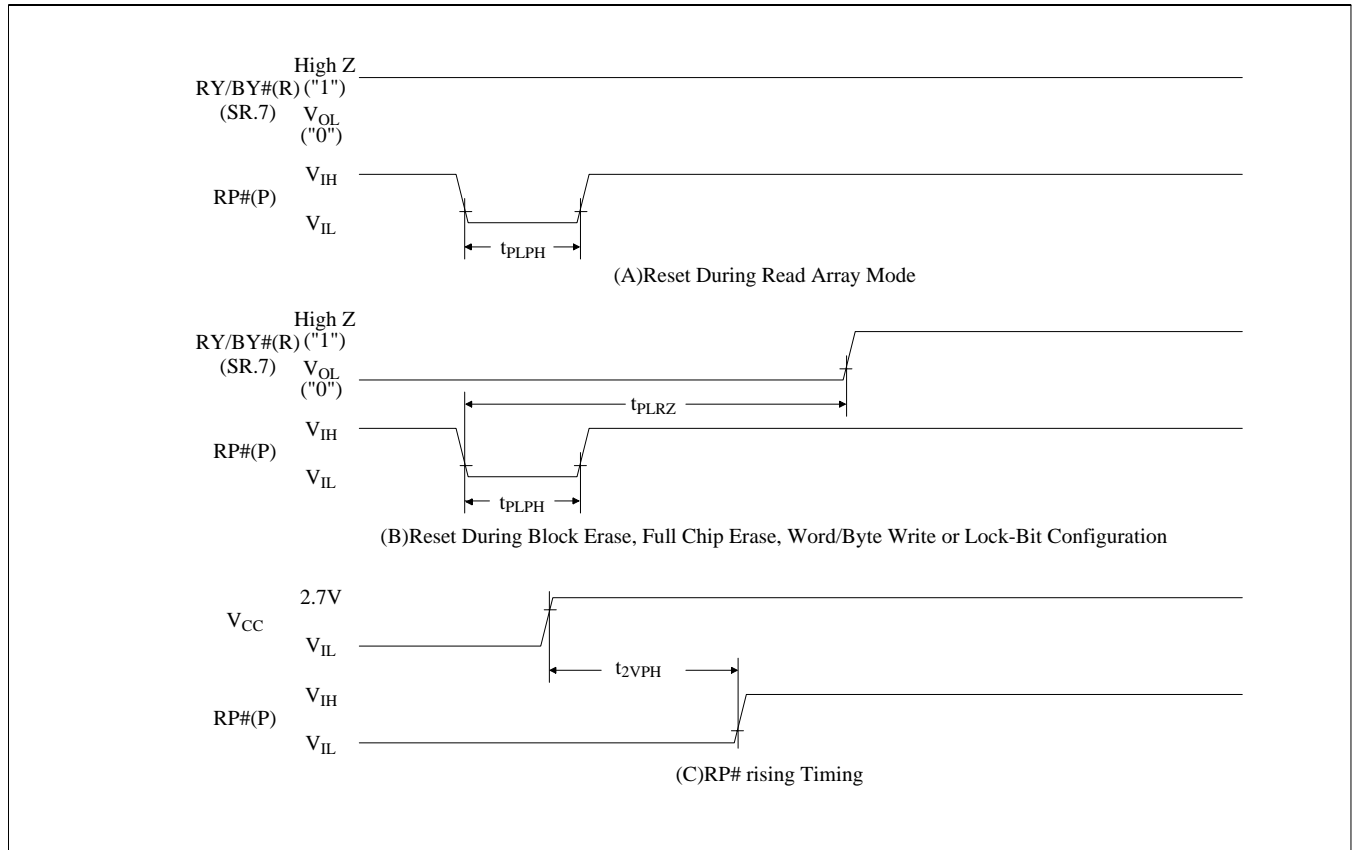

Figure 20. AC Waveform for Reset Operation

Reset AC Specifications

Sym.	Parameter	Notes	Min.	Max.	Unit
t_{PLPH}	RP# Pulse Low Time	2	100		ns
t_{PLRZ}	RP# Low to Reset during Block Erase, Full Chip Erase, Word/Byte Write or Lock-Bit Configuration	1,2		30	μ s
t_{2VPH}	V_{CC} 2.7V to RP# High	2,3	100		ns

NOTES:

1. If RP# is asserted while a block erase, full chip erase, word/byte write or lock-bit configuration operation is not executing, the reset will complete within 100ns.
2. A reset time, t_{PHQV} , is required from the later of RY/BY#(SR.7) going High Z("1") or RP# going high until outputs are valid. Refer to AC Characteristics - Read-Only Operations for t_{PHQV} .
3. When the device power-up, holding RP# low minimum 100ns is required after V_{CC} has been in predefined range and also has been in stable there.

6.2.8 Block Erase, Full Chip Erase, Word/Byte Write and Lock-Bit Configuration Performance⁽³⁾

$$V_{CC}=2.7V-3.6V, T_A=-40^{\circ}C \text{ to } +85^{\circ}C$$

Sym.	Parameter		Notes	V _{CCW} =2.7V-3.6V			V _{CCW} =11.7V-12.3V			Unit
				Min.	Typ. ⁽¹⁾	Max.	Min.	Typ. ⁽¹⁾	Max.	
t _{WHQV1}	Word Write Time	32K word Block	2		33	200		20		μs
t _{EHQV1}		4K word Block	2		36	200		27		μs
	Byte Write Time	64K byte Block	2		31	200		19		μs
		8K byte Block	2		32	200		26		μs
	Block Write Time (In word mode)	32K word Block	2		1.1	4		0.66		s
		4K word Block	2		0.15	0.5		0.12		s
	Block Write Time (In byte mode)	64K byte Block	2		2.2	7		1.4		s
		8K byte Block	2		0.3	1		0.25		s
t _{WHQV2}	Block Erase Time	32K word Block	2		1.2	6		0.9		s
t _{EHQV2}		64K byte Block	2							
		4K word Block	2		0.6	5		0.5		s
		8K byte Block	2							
	Full Chip Erase Time		2		22.8	114		17.5		s
t _{WHQV3}	Set Lock-Bit Time		2		56	200		42		μs
t _{EHQV3}										
t _{WHQV4}	Clear Block Lock-Bits Time		2		1	5		0.69		s
t _{EHQV4}										
t _{WHRZ1}	Word/Byte Write Suspend Latency Time to Read		4		6	15		6	15	μs
t _{EHRZ1}										
t _{WHRZ2}	Block Erase Suspend Latency Time to Read		4		16	30		16	30	μs
t _{EHRZ2}										
t _{ERES}	Latency Time from Block Erase Resume Command to Block Erase Suspend Command		5		600			600		μs

NOTES:

1. Typical values measured at T_A=+25°C and V_{CC}=3.0V, V_{CCW}=3.0V or 12.0V. Assumes corresponding lock-bits are not set. Subject to change based on device characterization.
2. Excludes system-level overhead.
3. Sampled but not 100% tested.
4. A latency time is required from issuing suspend command(WE# or CE# going high) until RY/BY# going High Z or SR.7 going "1".
5. If the time between writing the Block Erase Resume command and writing the Block Erase Suspend command is shorter than t_{ERES} and both commands are written repeatedly, a longer time is required than standard block erase until the completion of the operation.

A-1 RECOMMENDED OPERATING CONDITIONS

A-1.1 At Device Power-Up

AC timing illustrated in Figure A-1 is recommended for the supply voltages and the control signals at device power-up. If the timing in the figure is ignored, the device may not operate correctly.

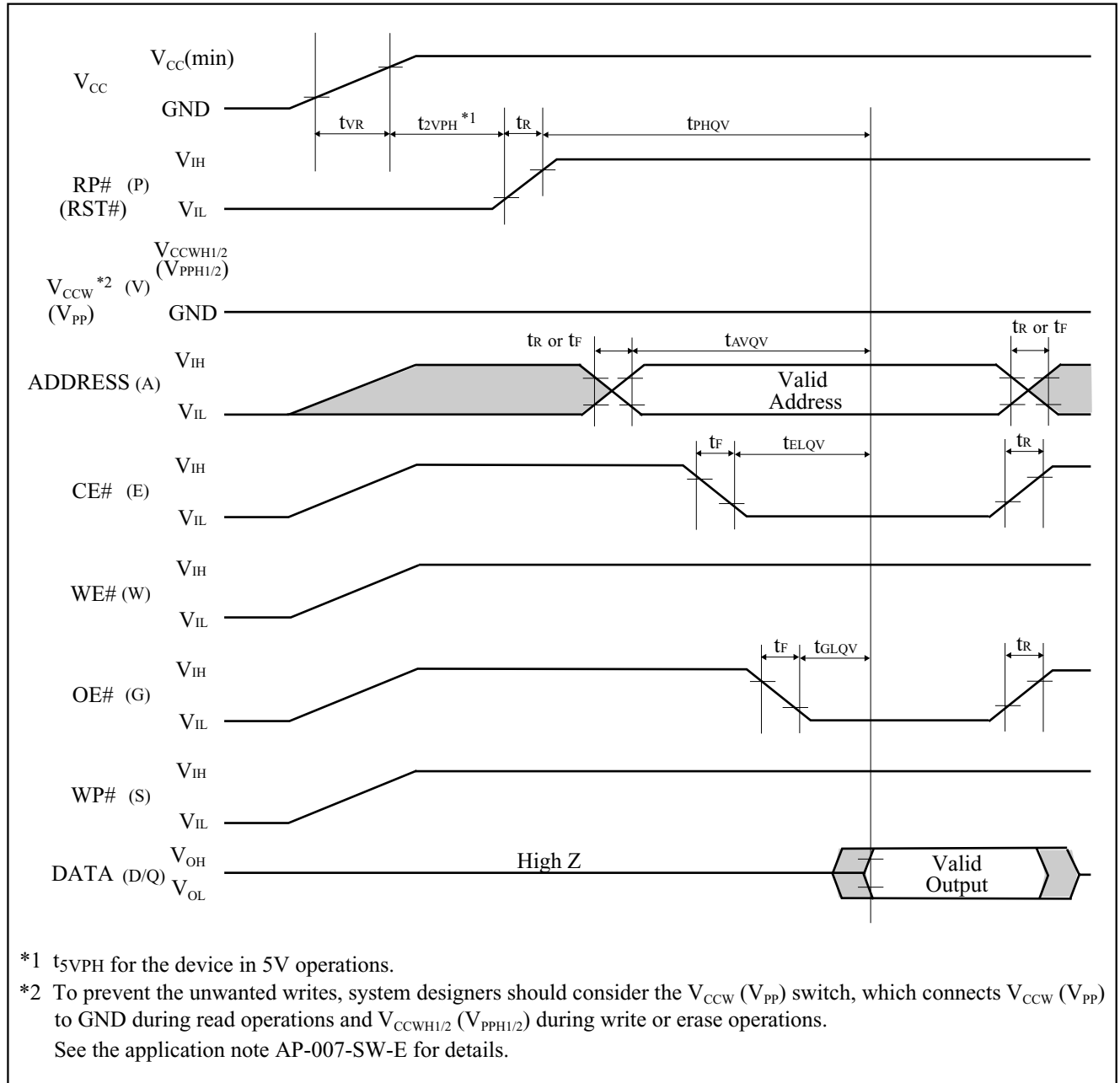

Figure A-1. AC Timing at Device Power-Up

For the AC specifications t_{VR} , t_R , t_F in the figure, refer to the next page. See the “ELECTRICAL SPECIFICATIONS” described in specifications for the supply voltage range, the operating temperature and the AC specifications not shown in the next page.

A-1.1.1 Rise and Fall Time

Symbol	Parameter	Notes	Min.	Max.	Unit
t_{VR}	V_{CC} Rise Time	1	0.5	30000	$\mu\text{s}/\text{V}$
t_R	Input Signal Rise Time	1, 2		1	$\mu\text{s}/\text{V}$
t_F	Input Signal Fall Time	1, 2		1	$\mu\text{s}/\text{V}$

NOTES:

1. Sampled, not 100% tested.
2. This specification is applied for not only the device power-up but also the normal operations.
 $t_R(\text{Max.})$ and $t_F(\text{Max.})$ for RP# (RST#) are $20\mu\text{s}/\text{V}$.

A-1.2 Glitch Noises

Do not input the glitch noises which are below V_{IH} (Min.) or above V_{IL} (Max.) on address, data, reset, and control signals, as shown in Figure A-2 (b). The acceptable glitch noises are illustrated in Figure A-2 (a).

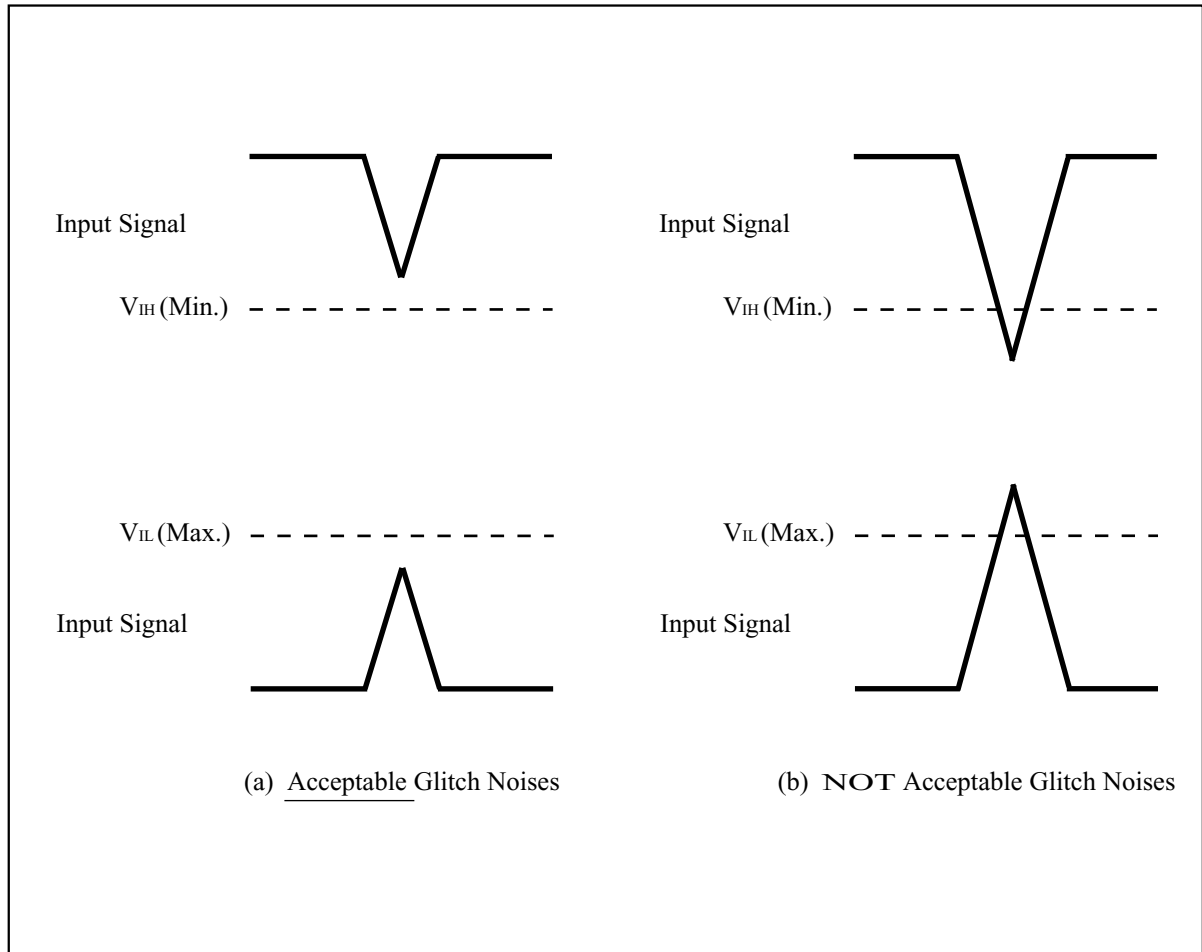

Figure A-2. Waveform for Glitch Noises

See the “DC CHARACTERISTICS” described in specifications for V_{IH} (Min.) and V_{IL} (Max.).

A-2 RELATED DOCUMENT INFORMATION⁽¹⁾

Document No.	Document Name
AP-001-SD-E	Flash Memory Family Software Drivers
AP-006-PT-E	Data Protection Method of SHARP Flash Memory
AP-007-SW-E	RP#, V_{PP} Electric Potential Switching Circuit

NOTE:

1. International customers should contact their local SHARP or distribution sales office.