

T-1 3/4 PACKAGE SOLID STATE LAMP

MVL-524UW

Description

The MVL-524UW a white source color device, is made with InGaN (on SiC substrate) LED die.
The package is T-1 3/4(5mm) water clear plastic lens package.

Applications

- Push-button backlighting
- LCD backlighting
- Symbol backlighting
- Front panel indicator
- Flashlight

Features

- High Luminous intensity
- High efficiency
- General color rendering index, Ra=85

Package Dimensions

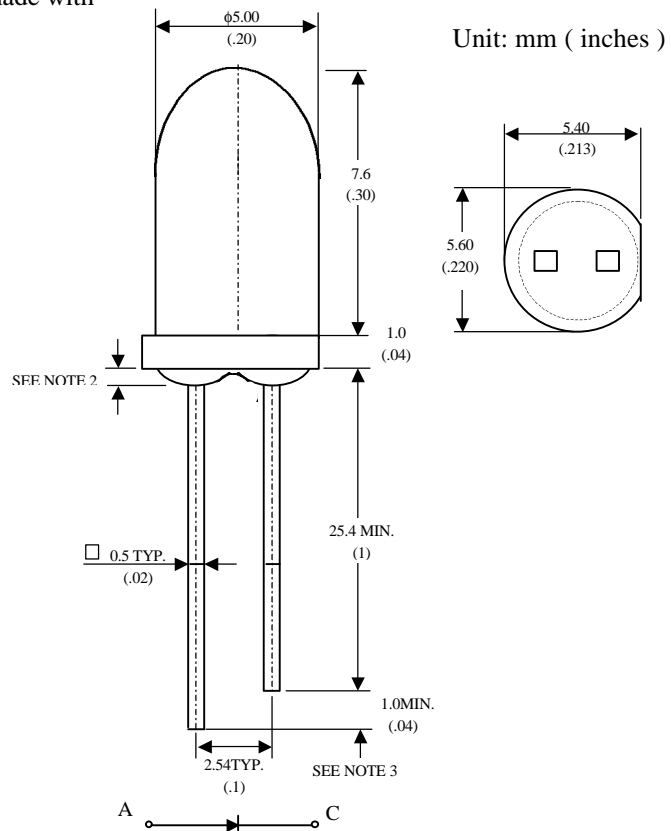

Notes :

1. Tolerance is ± 0.25 mm (.010") unless otherwise noted.
2. Protruded resin under flange is 1.5 mm (.059") max.
3. Lead spacing is measured where the leads emerge from the package.

Absolute Maximum Ratings

@ $T_A=25^\circ\text{C}$

Parameter	Symbol	Maximum Rating	Unit
Peak Forward Current(1/10 Duty Cycle@1KHz)	I_{pf}	100	mA
Continuous Forward Current	I_{af}	30	mA
Reverse Voltage	V_R	5	V
Operating Temperature Range	T_{opr}	-20°C to + 80°C	
Storage Temperature Range	T_{stg}	-30°C to + 100°C	
Electrostatic Discharge Threshold(HBM)	E_{ot}	1000	V
Solder Temperature 1.6 mm from body for 3 seconds at 260°C			

UNI

Unity Opto Technology Co., Ltd.

01/08/2002

Optical-Electrical Characteristics

@ $T_A=25^\circ\text{C}$

Parameter	Test Conditions	Symbol	Min .	Typ .	Max .	Unit .
Luminous Intensity	$I_F=20\text{mA}$	I_V	1100	2200	-	mcd
Forward Voltage	$I_F=20\text{mA}$	V_F	-	3.6	4.0	V
Reverse Current	$V_R=5\text{V}$	I_R	-	-	10	μA
Viewing Angle	$I_F=20\text{mA}$	$2\theta_{1/2}$	-	20	-	deg.
C.I.E. 1931 Chromaticity Coordinates	$I_F=20\text{mA}$	x	-	0.30	-	-
		y	-	0.30	-	-

Typical Optical-Electrical Characteristic Curves

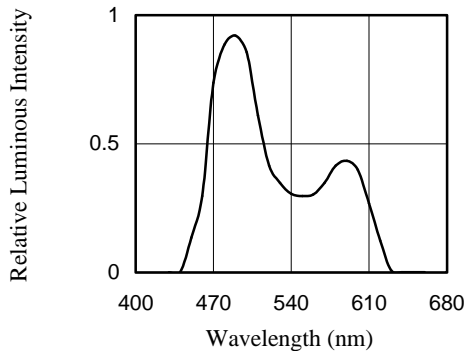

FIG.1 RELATIVE LUMINOUS INTENSITY VS. WAVELENGTH

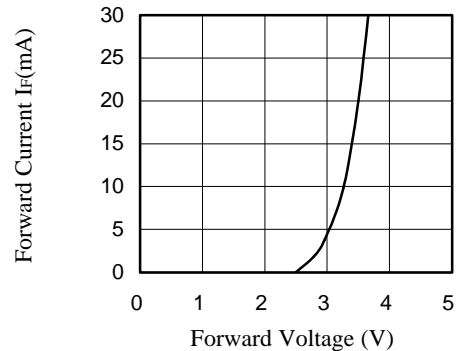

FIG.2 FORWARD CURRENT VS. FORWARD VOLTAGE

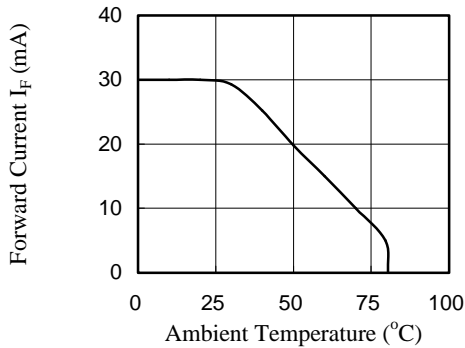

FIG.3 FORWARD CURRENT VS. AMBIENT TEMPERATURE

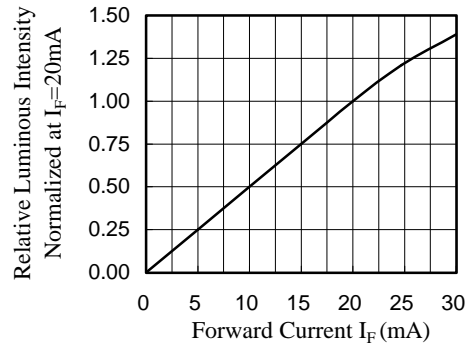

FIG.2 RELATIVE LUMINOUS INTENSITY VS. FORWARD CURRENT

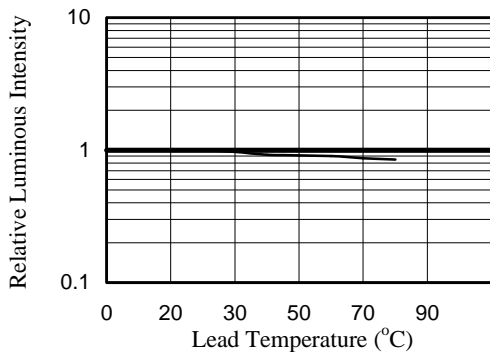

FIG.2 RELATIVE LUMINOUS INTENSITY VS. LEAD TEMPERATURE

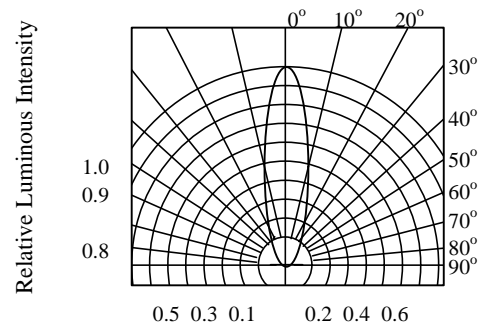

FIG.4 RADIATION DIAGRAM