

Technical Data Sheet

5484/R5DC-AJLB/X/MS

Features

- High luminous intensity output
- Oval Shape
- Well defined spatial radiation
- Wide viewing angle ($2\theta_{1/2}$) : $100^\circ / 40^\circ$
- UV resistant epoxy
- The product itself will remain within RoHS compliant version



Descriptions

- This precision optical performance oval LED is specifically designed for passenger information signs
- This lamp has matched radiation patterns with yellow, blue or green mixing color applications
- Superior performance in outdoor environment

Applications

- Color graphic signs
- Message boards
- Variable message signs (VMS)
- Commercial outdoor advertising

Device Selection Guide

LED Part No.	Chip Material	Emitted Color	Lens Color	Stopper
5484/R5DC-AJLB/MS	AlGaInP	Hyper red	Red Diffused	No
5484/R5DC-AJLB/P/MS				Yes

Package Dimensions

Stopper Type

No Stopper Type

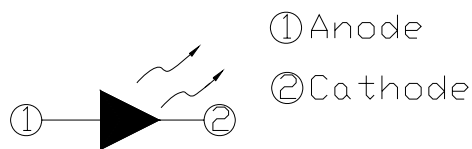
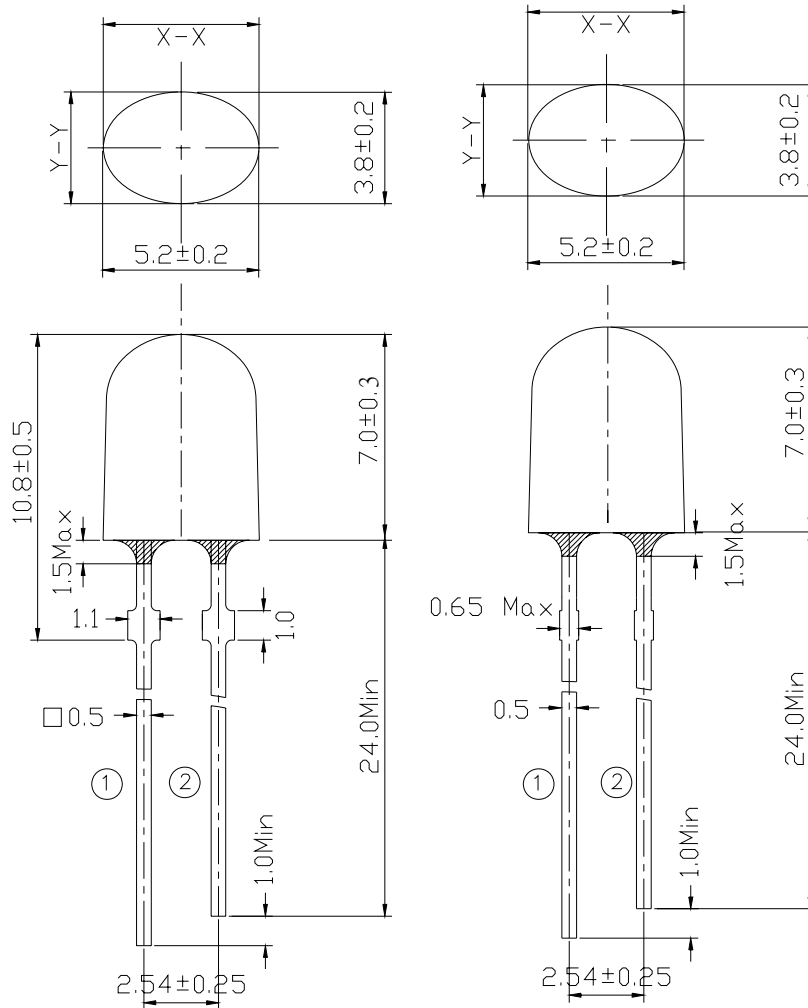

Notes:

- Other dimensions are in millimeters, tolerance is 0.25mm except being specified.
- Protruded resin under flange is 1.5mm Max LED.
- Bare copper alloy is exposed at tie-bar portion after cutting.



Technical Data Sheet

5484/R5DC-AJLB/X/MS

Absolute Maximum Rating ($T_a=25^{\circ}\text{C}$)

Parameter	Symbol	Absolute Maximum Rating	Unit
Forward Current	I_F	50	mA
Pulse Forward Current (Duty 1/10@ 1KHz)	I_{FP}	100	mA
Operating Temperature	T_{opr}	-40 ~ +85	$^{\circ}\text{C}$
Storage Temperature	T_{stg}	-40 ~ +100	$^{\circ}\text{C}$
Soldering Temperature	T_{sol}^*	260 \pm 5	$^{\circ}\text{C}$
Power Dissipation	P_d	120	mW
Reverse Voltage	V_R	5	V

Notes: * Soldering time \leq 5 seconds.

Electro-Optical Characteristics ($T_a=25^{\circ}\text{C}$)

Parameter	Symbol	Min.	Typ.	Max.	Unit	Condition
Luminous Intensity	I_V	900	1100	1800	mcd	$I_F=20\text{mA}$
Viewing Angle	$2\theta_{1/2}$	--	X:100Y:40	--	deg	
Peak Wavelength	λ_p	--	632	--	nm	
Dominant Wavelength	λ_d	620	624	628		
Spectrum Half width	$\Delta\lambda$	--	20	--		
Forward Voltage	V_F	1.8	2.0	2.4	V	
Reverse Current	I_R	--	--	10	μA	$V_R=5\text{V}$

Rank Combination ($I_F=20\text{mA}$)

Rank	J	K	L
Luminous Intensity	900~1125	1125~1425	1425~1800

*Measurement Uncertainty of Luminous Intensity: $\pm 15\%$

Unit:mcd

Rank	1	2	3
Forward Voltage	1.8~2.0	2.0~2.2	2.2~2.4

*Measurement Uncertainty of Forward Voltage: $\pm 0.1\text{V}$

Unit:V

Rank	1	2
Dominant Wavelength	620~624	624~628

*Measurement Uncertainty of Dominant Wavelength $\pm 1.0\text{nm}$

Unit:nm

*The quantity ratio of the ranks is decided by EVERLIGHT.

5484/R5DC-AJLB/X/MS

Typical Electro-Optical Characteristics Curves

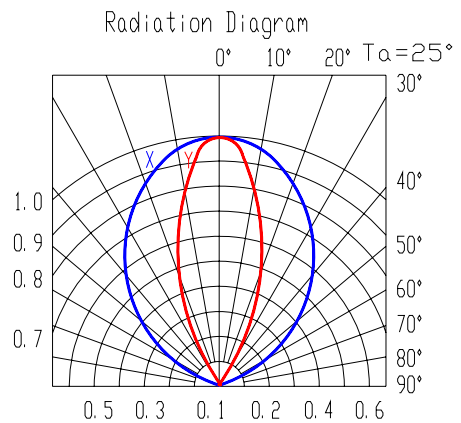
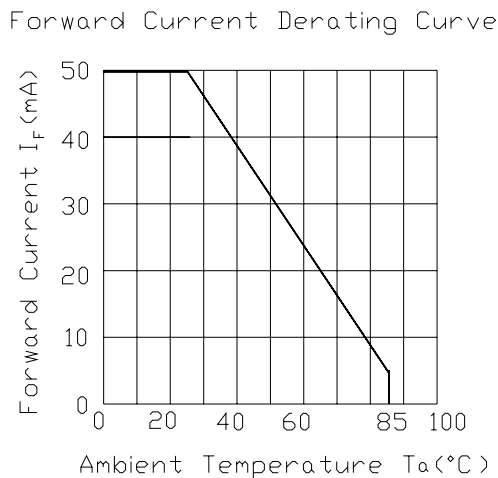
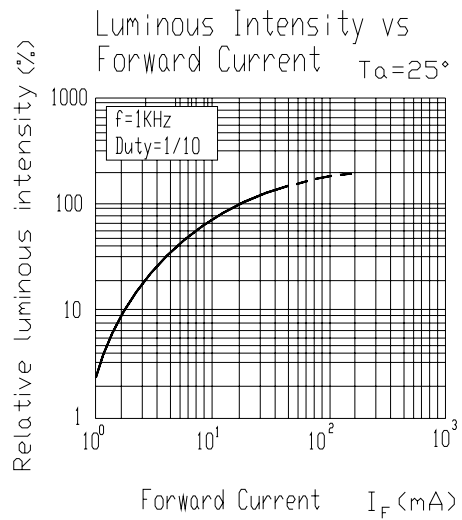
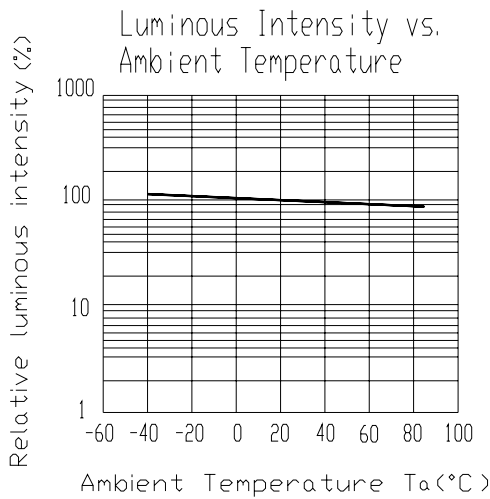
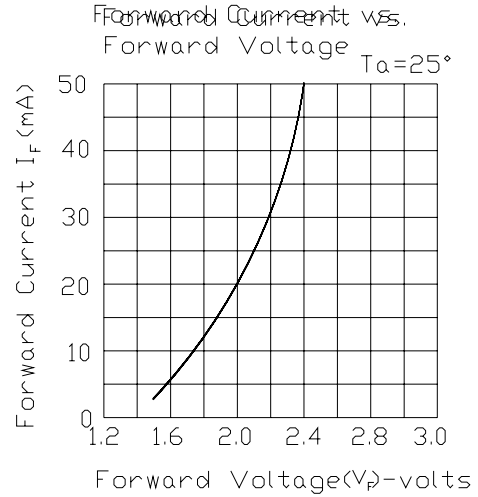
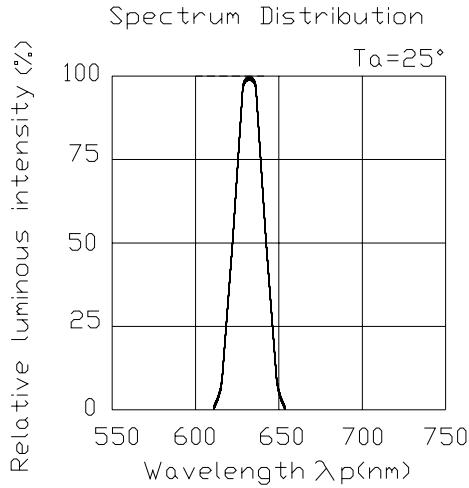



Technical Data Sheet

5484/R5DC-AJLB/X/MS

Packing Quantity Specification

1.500PCS/1Bag , 5Bags/1Box

2.10Boxes/1Carton

Label Form Specification

EVERLIGHT	
CPN:	
P/N:	RoHS
5484/R5DC-AJLB/X/MS	
QTY :	CAT:
LOT NO :	HUE:
	REF:
MADE IN TAIWAN	

CPN: Customer's Production Number

P/N : Production Number

QTY: Packing Quantity

CAT: Ranks of Luminous Intensity and Forward Voltage

HUE: Ranks of Dominant Wavelength

REF: Reference

LOT No: Lot Number

MADE IN TAIWAN: Production Place



Technical Data Sheet

5484/R5DC-AJLB/X/MS

Notes

1. Above specification may be changed without notice. EVERLIGHT will reserve authority on material change for above specification.
2. When using this product, please observe the absolute maximum ratings and the instructions for using outlined in these specification sheets. EVERLIGHT assumes no responsibility for any damage resulting from use of the product which does not comply with the absolute maximum ratings and the instructions included in these specification sheets.
3. These specification sheets include materials protected under copyright of EVERLIGHT corporation. Please don't reproduce or cause anyone to reproduce them without EVERLIGHT's consent.
4. Soldering Condition

Careful attention should be paid during soldering. When soldering, leave more than 3mm from solder joint to case, and soldering beyond the base of the tie bar is recommended.

Avoiding applying any stress to the lead frame while the LEDs are at high temperature particularly when soldering.

Recommended soldering conditions:

Hand Soldering		DIP Soldering	
Temp. at tip of iron	400°C Max. (30W Max.)	Preheat temp.	100°C Max. (60 sec Max.)
Soldering time	3 sec Max.	Bath temp.	265 Max.
Distance	3mm Min.(From solder joint to case)	Bath time.	5 sec Max.
		Distance	3mm Min.

EVERLIGHT ELECTRONICS CO., LTD.
Office: No 25, Lane 76, Sec 3, Chung Yang Rd,
Tucheng, Taipei 236, Taiwan, R.O.C

Tel: 886-2-2267-2000, 2267-9936
Fax: 886-2267-6244, 2267-6189, 2267-6306
<http://www.everlight.com>