

42 V Input Window Voltage Detector with Diagnostic Function for Automotive Applications

No. EC-528-210917

OVERVIEW

The R3154N is a Window Voltage Detector suitable for functional safety requirement. This device monitors over-and-under output voltages from the power supply IC for a microprocessor and a sensor, and detects abnormal voltage of systems. Its undervoltage detection down to 0.55 V is suitable for low power devices. Also, operation check of voltage detection is available with the TEST pin.

KEY BENEFITS

- Power supply from battery enables the voltage detector to operate independently from the power source.
- High-accuracy over-and-undervoltage detection from -1.25% to 0.75% and the hysteresis of Max. 0.75%.
- Overvoltage detection: 0.75 V at minimum, Undervoltage detection: 0.55 V at minimum.
- Compact package of SOT-23-6. Safe and secure adjacent pin configuration to prevent a short circuit.

KEY SPECIFICATIONS

- Operating Voltage Range (Max. Rating):
3.0 V to 42.0 V (50.0 V)
- Operating Temperature Range: -40 °C to 125 °C
- Supply Current: Typ. 2.0 μA
- Overvoltage Detection: 0.75 V to 3.70 V (in 0.01 V step)
Accuracy ($V_{OVSET} > 0.9$ V): ± 0.5 % ($T_a = 25$ °C)
-1.25 % to 0.75 % (-40 °C to 125 °C)
- Undervoltage Detection: 0.55 V to 3.30 V (in 0.01 V step)
Accuracy ($V_{UVSET} > 0.66$ V): ± 0.5 % ($T_a = 25$ °C)
-1.25 % to 0.75 % (-40 °C to 125 °C)
- Detection Release Hysteresis: Typ. 0.5 %
- Detection Release Time: Typ. 20 μs
- Release Delay Time: Typ. 4 ms ($C_D = 0.01$ μF)
- Output Type: Nch. Open Drain

PACKAGE

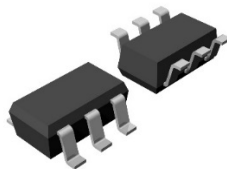

SOT-23-6
2.9 x 2.8 x 1.1 (mm)

SELECTION GUIDE

Product Name	Package	Quantity per Reel
R3154NxxxA-TR-##	SOT-23-6	3,000 pcs

xxx: The combination of an overvoltage detection setting voltage (V_{OVSET}) and an undervoltage detection setting voltage (V_{UVSET})
Refer to *Product-specific Electrical Characteristics* for details.

#: Quality Class

Refer to *SELECTION GUIDE* for details.

TYPICAL APPLICATIONS

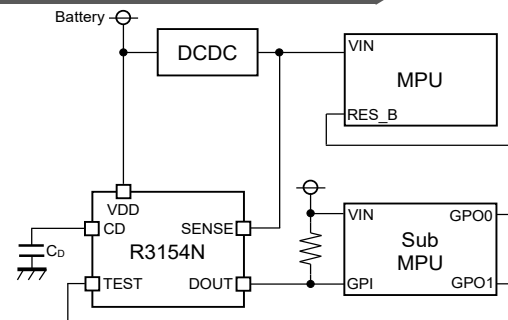

C_D : a capacitor corresponding to the set release delay time

APPLICATIONS

- Power supply voltage monitoring for systems which require fault detection, such as ECU and ADAS.
- Power supply voltage monitoring for control units such as EV inverters and Charge Controllers.

SELECTION GUIDE

The detection setting voltages and quality class are user-selectable.

Selection Guide

Product Name	Package	Quantity per Reel	Pb Free	Halogen Free
R3154NxxxA-TR-##	SOT-23-6	3,000 pcs	Yes	Yes

xxx: The combination of an overvoltage detection setting voltage (V_{OVSET}) and an undervoltage detection setting voltage (V_{UVSET}).

Refer to *Product-specific Electrical Characteristics* for details.

#: Quality Class

Quality Class	##	Operating Temperature Range	Test Temperature
A	AE	-40°C to 125°C	25°C, High
R	R	-40°C to 125°C	Low, 25°C, High

BLOCK DIAGRAM

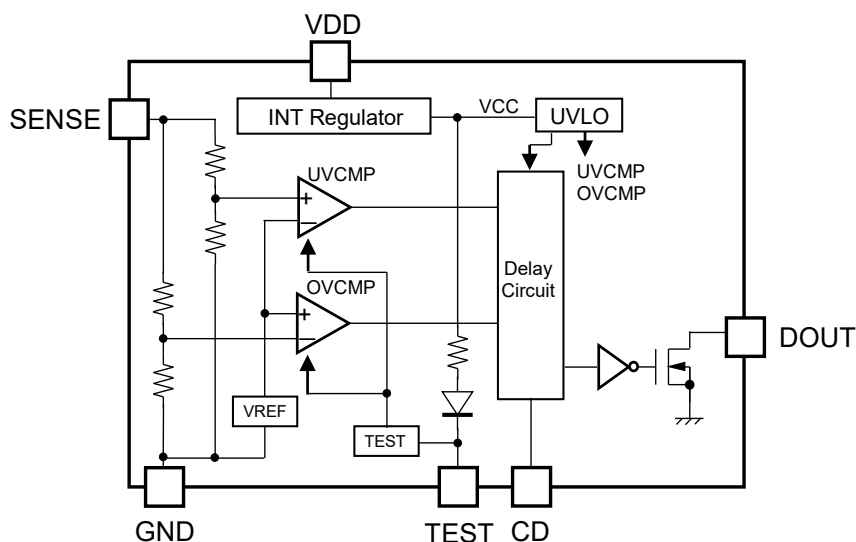

R3154N Block Diagram

PIN DESCRIPTIONS

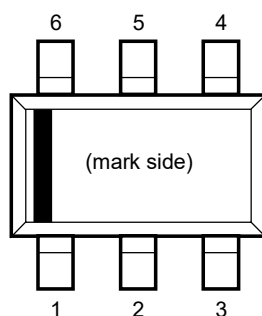

SOT-23-6 Pin Configuration

Pin Descriptions

Pin No.	Symbol	Description
1	VDD	Supply Voltage Pin
2	CD	Release Delay Time Set Pin ("Open" when not connected)
3	DOUT	Voltage Fault Detection Output Pin ("Low" at detection)
4	TEST	TEST Pin ("Low" at operation check of voltage detection)
5	GND	GND Pin
6	SENSE	SENSE Voltage Input Pin

Internal Equivalent Circuit for Each Pin

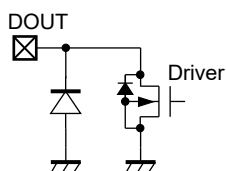

DOUT Pin

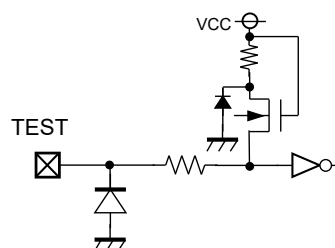

TEST Pin

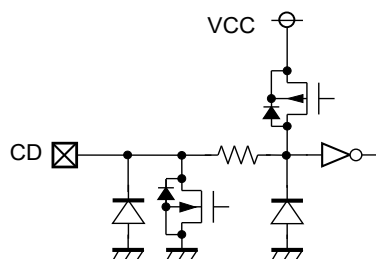

CD Pin

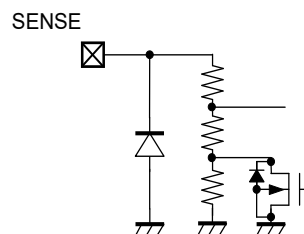

SENSE Pin

ABSOLUTE MAXIMUM RATINGS

Absolute Maximum Ratings

Symbol	Parameter	Rating	Unit
V _{DD}	Supply Voltage	-0.3 to 50.0	V
	Peak Voltage ⁽¹⁾	60	V
V _{CD}	CD Pin Output Voltage	-0.3 to 20.0	V
V _{DOUT}	DOUT Pin Output Voltage	-0.3 to 20.0	V
V _{TEST}	TEST Pin Voltage	-0.3 to 20.0	V
V _{SENSE}	SENSE Pin Voltage	-0.3 to 20.0	V
I _{DOUT}	DOUT Pin Output Current	30	mA
P _D	Power Dissipation	Refer to Appendix "POWER DISSIPATION"	
T _j	Junction Temperature Range	-40 to 150	°C
T _{stg}	Storage Temperature Range	-55 to 150	°C

ABSOLUTE MAXIMUM RATINGS

Electronic and mechanical stress momentarily exceeded absolute maximum ratings may cause permanent damage and may degrade the life time and safety for both device and system using the device in the field. The functional operation at or over these absolute maximum ratings are not assured.

RECOMMENDED OPERATING CONDITIONS

Recommended Operating Conditions

Symbol	Parameter	Rating	Unit
V _{DD}	Operating Voltage	3.0 to 42	V
V _{SENSE}	SENSE Input Voltage	0 to 6.0	V
V _{TEST}	TEST Pin Voltage	0 to 6.0	V
V _{UP}	DOUT Pin Pull-up Voltage	0 to 6.0	V
T _a	Operating Temperature Range	-40 to 125	°C

RECOMMENDED OPERATING CONDITIONS

All of electronic equipment should be designed that the mounted semiconductor devices operate within the recommended operating conditions. The semiconductor devices cannot operate normally over the recommended operating conditions, even if they are used over such ratings by momentary electronic noise or surge. And the semiconductor devices may receive serious damage when they continue to operate over the recommended operating conditions.

⁽¹⁾ Duration Time: Within 200 ms

ELECTRICAL CHARACTERISTICS

$V_{DD} = 14\text{ V}$, $C_D = 0.01\text{ }\mu\text{F}$, pulled-up to 5 V with 100 k Ω , unless otherwise specified.

The specifications surrounded by are guaranteed by design engineering at $-40^\circ\text{C} \leq T_a \leq 125^\circ\text{C}$.

R3154N (-AE) Electrical Characteristics

($T_a = 25^\circ\text{C}$)

Symbol	Parameter	Test Conditions	Min.	Typ.	Max.	Unit	
V_{OVDET}	Overvoltage (OV) Detector Threshold	$T_a = 25^\circ\text{C}$	$0.9\text{ V} < V_{OVSET}$	x0.995		x1.005	V
			$V_{OVSET} \leq 0.9\text{ V}$	-4.5		+4.5	mV
		$-40^\circ\text{C} \leq T_a \leq 125^\circ\text{C}$	$0.9\text{ V} < V_{OVSET}$	x0.9875		x1.0075	V
			$V_{OVSET} \leq 0.9\text{ V}$	-11.25		+6.75	mV
V_{UVDET}	Undervoltage (UV) Detector Threshold	$T_a = 25^\circ\text{C}$	$0.66\text{ V} < V_{UVSET}$	x0.995		x1.005	V
			$V_{UVSET} \leq 0.66\text{ V}$	-3.3		+3.3	mV
		$-40^\circ\text{C} \leq T_a \leq 125^\circ\text{C}$	$0.66\text{ V} < V_{UVSET}$	x0.9875		x1.0075	V
			$V_{UVSET} \leq 0.66\text{ V}$	-8.25		+4.95	mV
V_{OVHYS}	Overvoltage (OV) Threshold Hysteresis		V_{OVDET} x0.0025	V_{OVDET} x0.005	V_{OVDET} x0.0075	V	
V_{UVHYS}	Undervoltage (UV) Threshold Hysteresis		V_{UVDET} x0.0025	V_{UVDET} x0.005	V_{UVDET} x0.0075	V	
I_{SS}	Supply Current	$V_{UVDET} < V_{SENSE} < V_{OVDET}$		2.0	5.0	μA	
R_{SENSE}	SENSE Pin Resistance ⁽¹⁾	Resistance between SENSE and GND	3		32	M Ω	
V_{UVLO}	UVLO Detector Threshold			1.8	2.7	V	
$V_{UVLOHYS}$	UVLO Threshold Hysteresis			0.1	0.3	V	
V_{DDL}	DOUT Pin Output Low-operating Voltage ⁽²⁾				1.7	V	
I_{OUT}	NMOS Driver Output Current	$V_{DD} = 3.0, V_{DS} = 0.1\text{ V}$	0.37	0.75		mA	
I_{LEAK}	NMOS Driver Leakage Current	$V_{DOUT} = 5.5\text{ V}$		0	1	μA	
V_{TESTH}	TEST Pin Input Voltage, "High"		1.6			V	
V_{TESTL}	TEST Pin Input Voltage, "Low"				0.5	V	
t_{DELAY}	Release Delay Time		2.5	4	8	ms	

All test items listed in Electrical Characteristics are done under the pulse load condition ($T_j \approx T_a = 25^\circ\text{C}$)

⁽¹⁾ Typ. value varies depending on the set value of detector threshold.

⁽²⁾ Minimum value of power supply voltage when an output voltage becomes 0.1V or less at detection.
(Pulled-up resistance: 100 k Ω , Pulled-up voltage: 5 V)

$V_{DD} = 14\text{ V}$, $C_D = 0.01\ \mu\text{F}$, pulled-up to 5 V with 100 k Ω , unless otherwise specified.

R3154N (-R) Electrical Characteristics

(-40°C ≤ Ta ≤ 125°C)

Symbol	Parameter	Test Conditions	Min.	Typ.	Max.	Unit	
V_{OVDET}	Overvoltage (OV) Detector Threshold	Ta = 25°C	0.9 V < V_{OVSET}	x0.995		x1.005	V
			$V_{OVSET} \leq 0.9\text{ V}$	-4.5		+4.5	mV
		-40°C ≤ Ta ≤ 125°C	0.9 V < V_{OVSET}	x0.9875		x1.0075	V
			$V_{OVSET} \leq 0.9\text{ V}$	-11.25		+6.75	mV
V_{UVDET}	Undervoltage (UV) Detector Threshold	Ta = 25°C	0.66V < V_{UVSET}	x0.995		x1.005	V
			$V_{UVSET} \leq 0.66\text{V}$	-3.3		+3.3	mV
		-40°C ≤ Ta ≤ 125°C	0.66 V < V_{UVSET}	x0.9875		x1.0075	V
			$V_{UVSET} \leq 0.66\text{V}$	-8.25		+4.95	mV
V_{OVHYS}	Overvoltage (OV) Threshold Hysteresis		V_{OVDET} x0.0025	V_{OVDET} x0.005	V_{OVDET} x0.0075	V	
V_{UVHYS}	Undervoltage (UV) Threshold Hysteresis		V_{UVDET} x0.0025	V_{UVDET} x0.005	V_{UVDET} x0.0075	V	
I_{SS}	Supply Current	$V_{UVDET} < V_{SENSE} < V_{OVDET}$		2.0	5.0	μA	
R_{SENSE}	SENSE Pin Resistance ⁽¹⁾	Resistance between SENSE and GND	3		32	MΩ	
V_{UVLO}	UVLO Detector Threshold			1.8	2.7	V	
$V_{UVLOHYS}$	UVLO Threshold Hysteresis			0.1	0.3	V	
V_{DDL}	DOUT Pin Output Low-operating Voltage ⁽²⁾				1.7	V	
I_{OUT}	NMOS Driver Output Current	$V_{DD} = 3.0$, $V_{DS} = 0.1\text{ V}$	0.37	0.75		mA	
I_{LEAK}	NMOS Driver Leakage Current	$V_{DOUT} = 5.5\text{ V}$		0	1	μA	
V_{TESTH}	TEST Pin Input Voltage, "High"		1.6			V	
V_{TESTL}	TEST Pin Input Voltage, "Low"				0.5	V	
t_{DELAY}	Release Delay Time		2.5	4	8	ms	

⁽¹⁾ Typ. value varies depending on the set value of detector threshold.

⁽²⁾ Minimum value of power supply voltage when an output voltage becomes 0.1V or less at detection.
(Pulled-up resistance: 100 k Ω , Pulled-up voltage: 5 V)

$V_{DD} = 14\text{ V}$, $C_D = 0.01\ \mu\text{F}$, pulled-up to 5 V with 100 k Ω , unless otherwise specified.

The specifications surrounded by are guaranteed by design engineering at $-40^\circ\text{C} \leq T_a \leq 125^\circ\text{C}$.

R3154N-AE Product-specific Electrical Characteristics

($T_a = 25^\circ\text{C}$)

Product name	V_{OVDET} (V)			V_{UVDET} (V)		
	Min.	Typ.	Max.	Min.	Typ.	Max.
R3154N201A	0.85550	0.86	0.86450	0.76615	0.77	0.77385
R3154N202A	0.74550	0.75	0.75450	0.54670	0.55	0.55330
R3154N203A	3.52230	3.54	3.55770	3.03475	3.05	3.06525
R3154N204A	1.32335	1.33	1.33665	1.16415	1.17	1.17585
R3154N205A	1.07460	1.08	1.08540	0.91540	0.92	0.92460
R3154N206A	0.86550	0.87	0.87450	0.72635	0.73	0.73365
R3154N207A	0.81550	0.82	0.82450	0.66665	0.67	0.67335

($-40^\circ\text{C} \leq T_a \leq 125^\circ\text{C}$)

Product name	V_{OVDET} (V)			V_{UVDET} (V)			V_{OVHYS} (V)			V_{UVHYS} (V)		
	Min.	Typ.	Max.	Min.	Typ.	Max.	Min.	Typ.	Max.	Min.	Typ.	Max.
R3154N201A	0.84875	0.86	0.86675	0.76038	0.77	0.77577	0.00215	0.00430	0.00645	0.00193	0.00385	0.00577
R3154N202A	0.73875	0.75	0.75675	0.54175	0.55	0.55495	0.00188	0.00375	0.00562	0.00138	0.00275	0.00412
R3154N203A	3.49575	3.54	3.56655	3.01188	3.05	3.07287	0.00885	0.01770	0.02655	0.00763	0.01525	0.02287
R3154N204A	1.31338	1.33	1.33997	1.15538	1.17	1.17877	0.00333	0.00665	0.00997	0.00293	0.00585	0.00877
R3154N205A	1.06650	1.08	1.08810	0.90850	0.92	0.92690	0.00270	0.00540	0.00810	0.00230	0.00460	0.00690
R3154N206A	0.85875	0.87	0.87675	0.72088	0.73	0.73547	0.00218	0.00435	0.00652	0.00183	0.00365	0.00547
R3154N207A	0.80875	0.82	0.82675	0.66163	0.67	0.67502	0.00205	0.00410	0.00615	0.00168	0.00335	0.00502

$V_{DD} = 14\text{ V}$, $C_D = 0.01\ \mu\text{F}$, pulled-up to 5 V with 100 k Ω , unless otherwise specified.

R3154N-R Product-specific Electrical Characteristics**($T_a = 25^\circ\text{C}$)**

Product name	V_{OVDET} (V)			V_{UVDET} (V)		
	Min.	Typ.	Max.	Min.	Typ.	Max.
R3154N201A	0.85550	0.86	0.86450	0.76615	0.77	0.77385
R3154N202A	0.74550	0.75	0.75450	0.54670	0.55	0.55330
R3154N203A	3.52230	3.54	3.55770	3.03475	3.05	3.06525
R3154N204A	1.32335	1.33	1.33665	1.16415	1.17	1.17585
R3154N205A	1.07460	1.08	1.08540	0.91540	0.92	0.92460
R3154N206A	0.86550	0.87	0.87450	0.72635	0.73	0.73365
R3154N207A	0.81550	0.82	0.82450	0.66665	0.67	0.67335

($-40^\circ\text{C} \leq T_a \leq 125^\circ\text{C}$)

Product name	V_{OVDET} (V)			V_{UVDET} (V)			V_{OVHYS} (V)			V_{UVHYS} (V)		
	Min.	Typ.	Max.	Min.	Typ.	Max.	Min.	Typ.	Max.	Min.	Typ.	Max.
R3154N201A	0.84875	0.86	0.86675	0.76038	0.77	0.77577	0.00215	0.00430	0.00645	0.00193	0.00385	0.00577
R3154N202A	0.73875	0.75	0.75675	0.54175	0.55	0.55495	0.00188	0.00375	0.00562	0.00138	0.00275	0.00412
R3154N203A	3.49575	3.54	3.56655	3.01188	3.05	3.07287	0.00885	0.01770	0.02655	0.00763	0.01525	0.02287
R3154N204A	1.31338	1.33	1.33997	1.15538	1.17	1.17877	0.00333	0.00665	0.00997	0.00293	0.00585	0.00877
R3154N205A	1.06650	1.08	1.08810	0.90850	0.92	0.92690	0.00270	0.00540	0.00810	0.00230	0.00460	0.00690
R3154N206A	0.85875	0.87	0.87675	0.72088	0.73	0.73547	0.00218	0.00435	0.00652	0.00183	0.00365	0.00547
R3154N207A	0.80875	0.82	0.82675	0.66163	0.67	0.67502	0.00205	0.00410	0.00615	0.00168	0.00335	0.00502

TYPICAL APPLICATION CIRCUIT

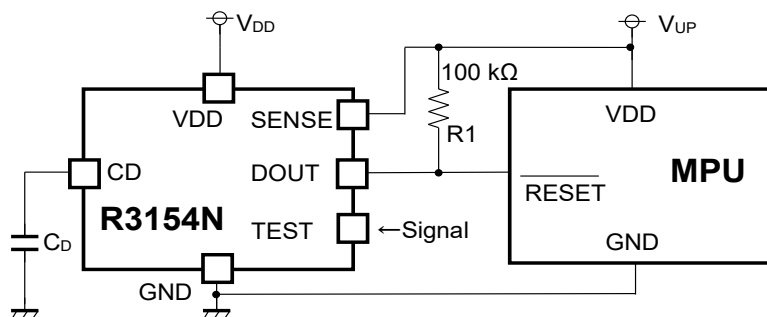

R3154N Typical Application Circuit

Recommended External Components

Symbol	Description
C_D	A capacitor should be selected corresponding to the set Release Delay Time. Refer to "Delay in Operation and Release Delay Time (t_{DELAY})" in THEORY OF OPERATION for details. When minimizing the release delay time, layout the circuit without any capacitor.
R1	The "Low" voltage of the DOUT output is determined by the division ratio of the on resistance of the NMOS driver and the pull-up resistance value (R1). The on-resistance of the NMOS driver is calculated from the "NMOS driver output current". Select the pull-up resistance value (R1) to bring the "Low" voltage of the DOUT output to the desired voltage. The "High" level of the DOUT output is determined by the division ratio of the leakage current of the NMOS driver and the pull-up resistance value (R1). The leakage current of the NMOS driver is calculated from the "NMOS driver leakage current". Confirm if the "High" voltage of the DOUT output is the desired voltage. "Electrical Characteristic" is evaluated in conditions that pull-up voltage = 5 V and R1 = 100 kΩ.

THEORY OF OPERATION

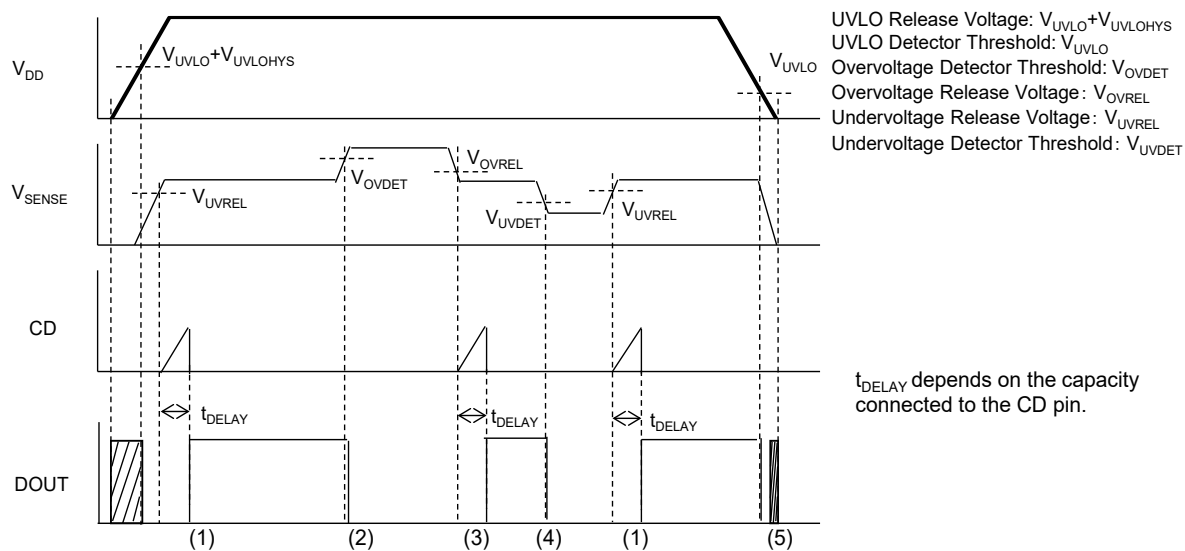

R3154N Timing Chart

- (1) When the SENSE pin voltage (V_{SENSE}) exceeds the undervoltage release voltage (V_{UVREL}), the DOUT pin outputs "High" after the release delay time (t_{DELAY}).
- (2) When V_{SENSE} exceeds the overvoltage detector threshold (V_{OVDET}) by increasing of the voltage, the DOUT pin outputs "Low" after the detection delay time (Typ. 20 μ s) and this triggers the overvoltage detecting state.
- (3) When V_{SENSE} decreases less than the overvoltage release voltage (V_{OVREL}), the DOUT pin outputs "High" after the release delay time (t_{DELAY}).
- (4) When V_{SENSE} decreases less than the undervoltage detector threshold (V_{UVDET}), the DOUT pin outputs "Low" after the detection delay time (Typ. 20 μ s) and this triggers the undervoltage detecting state.
- (5) When the VDD pin voltage (V_{DD}) decreases less than the UVLO detector threshold (V_{UVLO}), the DOUT pin outputs "Low". Note that DOUT cannot maintain "Low" when the VDD pin voltage drops further and becomes lower than V_{DDL} .

Delay Operation and Release Delay Time (t_{DELAY})

At Undervoltage Detection

A higher voltage than the undervoltage release voltage (V_{UVREL}) supplied to the SENSE pin triggers charging of the external capacitor (C_{D} capacitance), then the CD pin voltage (V_{CD}) increases. The DOUT pin voltage (V_{DOUT}) maintains "Low" until V_{CD} reaches the CD pin threshold voltage (V_{TCD}). When V_{CD} exceeds V_{TCD} , V_{DOUT} transitions from "Low" to "High". The release delay time (t_{DELAY}) is the period from the time the SENSE pin voltage (V_{SENSE}) exceeds V_{UVREL} to a rising edge of V_{DOUT} . V_{DOUT} transitions from "Low" to "High" and it leads to discharging of the C_{D} capacitor. Without the C_{D} capacitor, it becomes the short t_{DELAY} (Typ. 20 μs) depending on the circuit delay and CD pin stray capacity. When the higher voltage than V_{UVDET} is supplied to the SENSE pin, the detection delay time (t_{PHL}), which is the period that V_{DOUT} transitions from "High" to "Low", remains constant regardless of the capacitance value of the external capacitor.

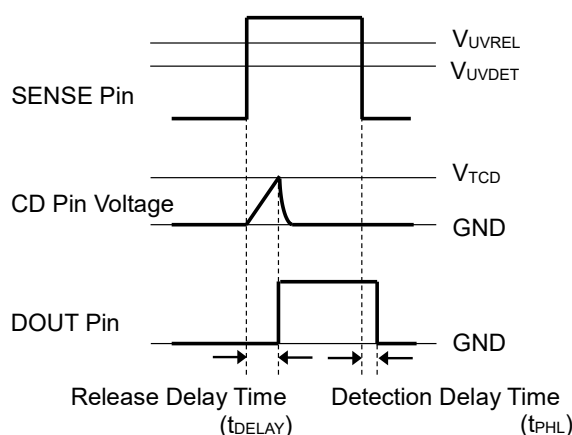

Undervoltage Release Delay Timing Chart

Calculation of Release Delay Time (t_{DELAY}) at Undervoltage Detection

The typical value of the release delay time (t_{DELAY}) with the capacitance of the external capacitor (C_{D}) is calculated in the following equation:

$$t_{\text{DELAY}} (\text{s}) = 0.73 \times C_{\text{D}} (\text{F}) / (1.8 \times 10^{-6})$$

t_{DELAYn} is the period until the DOUT pin voltage reaches 2.5 V after the pulse voltage of $(V_{\text{UVDET}} + V_{\text{OVDET}}) / 2$ V increased from $(V_{\text{UVDET}} \times 0.97)$ V is supplied to the SENSE pin when DOUT pin is pulled up to 5 V with 100 k Ω .

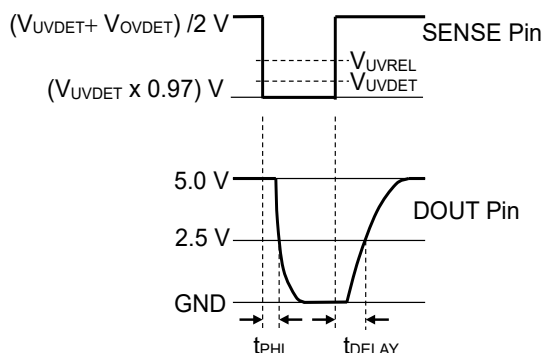

At Overvoltage Detection

A lower voltage than the overvoltage release voltage (V_{OVREL}) supplied to the SENSE pin triggers charging of the external capacitor (C_D capacitance), then the CD pin voltage (V_{CD}) increases. The DOUT pin voltage (V_{DOUT}) maintains “Low” until V_{CD} reaches the CD pin threshold voltage (V_{TCD}). When V_{CD} exceeds V_{TCD} , V_{DOUT} is inverted from “Low” to “High”. The release delay time (t_{DELAY}) is the period from the time the SENSE pin voltage (V_{SENSE}) falls below V_{OVREL} to a rising edge of V_{DOUT} . V_{DOUT} transitions to “High”. V_{DOUT} transitions from “Low” to “High” and it leads to discharging of the C_D capacitor. Without the C_D capacitor, it becomes the short t_{DELAY} (Typ. 20 μ s) depending on the circuit delay and CD pin stray capacity. When the higher voltage than V_{OVDET} is supplied to the SENSE pin, the detection delay time (t_{PHL}), which is the period that V_{DOUT} transitions from “High” to “Low”, remains constant regardless of the capacitance value of the external capacitor.

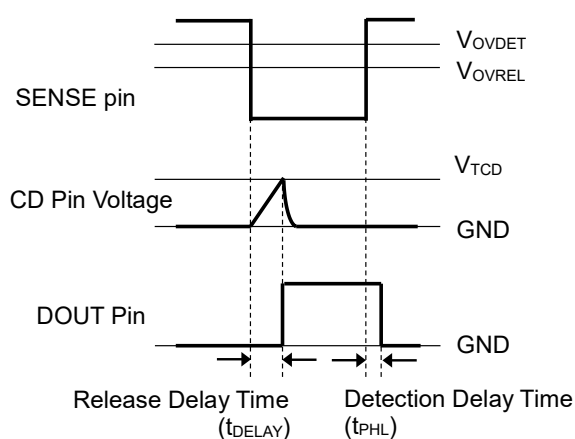

Overvoltage Release Delay Timing Chart

Calculation of Release Delay Time (t_{DELAY}) at Overvoltage Detection

The typical value of the release delay time (t_{DELAY}) with the capacitance of the external capacitor (C_D) is calculated in the following equation:

$$t_{DELAY} (s) = 0.73 \times C_D (F) / (1.8 \times 10^{-6})$$

t_{DELAY} is the period until the DOUT pin voltage reaches 2.5 V after the pulse voltage of $(V_{UVDET} + V_{OVDET}) / 2$ V decreased from $(V_{OVDET} \times 1.03)$ V is supplied to the SENSE pin when DOUT pin is pulled up to 5 V with 100 k Ω .

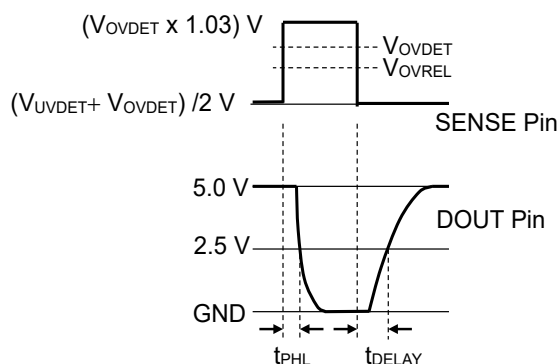

Operation Check of Voltage Detection Function with TEST Pin

Voltage Detection Function is to set DOUT to “Low” by inputting “Low” to the TEST pin, even when the SENSE pin voltage (V_{SENSE}) is within a range of the release voltage. If the DOUT does not become “Low” even V_{SENSE} is within the release voltage range and “Low” signal is input to the TEST pin, it can be judged that the IC has a fault. To cancel this function, set the TEST pin to “High” voltage or “Open”. When the TEST pin is open, the DOUT becomes “High” with pulled-up voltage in the IC.

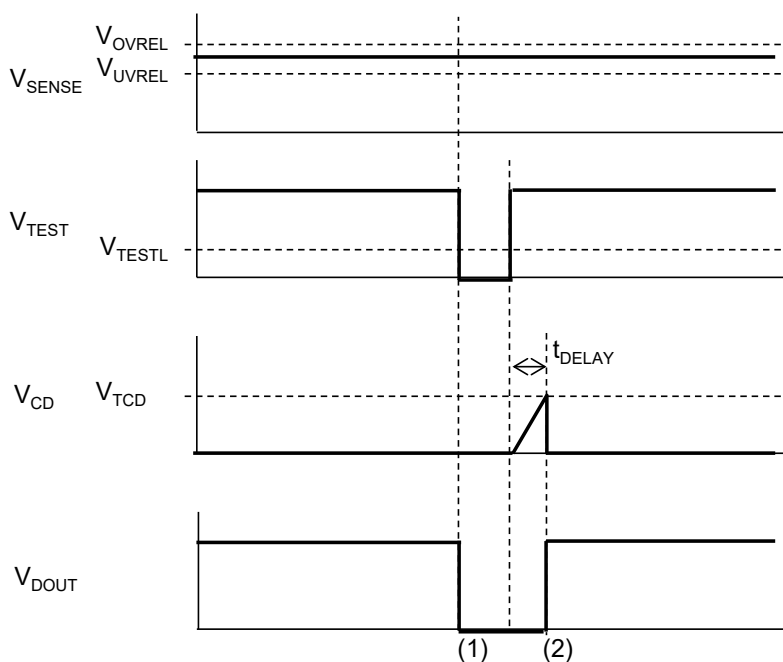

TEST Pin Timing Chart

- (1) When inputting “Low” to the TEST pin, the DOUT is fixed to “Low” after the detection delay time (Typ. 20 μs) even if the SENSE pin voltage (V_{SENSE}) is within a range of the release voltage. The “Low” signal of TEST pin voltage should be 50 μs or more.
- (2) When the TEST pin transitions from “Low” to “High”, the DOUT pin outputs “High” after the release delay time (t_{DELAY}). At this time, the TEST pin should maintain “High” for the release delay time or longer. Even when the external capacitor (C_{D} capacitance) is not connected, it should maintain “High” for 50 μs or more.

APPLICATION INFORMATION

The concept of “H” level of TEST pin

The R3154 has a voltage regulator (INT regulator) inside the IC. Major functions of the IC are operated by VCC (Typ. 3.3V) generated by INT regulator from input voltage, VDD.

TEST pin is pulled up to VCC voltage via 100kΩ as it can be set to open when TEST pin is unused.

When the voltage detect function is in use, when input “Low” voltage to TEST pin, then DOUT pin becomes “Low”. But when the voltage detect function is in no use, if “High” voltage is input to TEST pin, the current which is determined by the following equation flows continuously. This makes the supply current increase.

$$(VCC - \text{TEST “High” voltage}) / 100k\Omega \quad (VCC > \text{TEST “High” voltage})$$

Unless there's a specific reason to avoid an OPEN pin condition, it's recommended to be left OPEN when TEST pin is not used.

As the circuit configuration prevents a reverse current from TEST pin to VCC, even when being used in condition of TEST “High” voltage > VCC, supply current doesn't increase and VCC voltage doesn't vary.

TYPICAL CHARACTERISTICS

Note: Typical Characteristics are intended to be used as reference data; they are not guaranteed.

1) UV/OV Detection Release Voltage vs. Temperature

$V_{DD} = 14\text{ V}$,

$V_{UVSET} = 3.3\text{ V}$

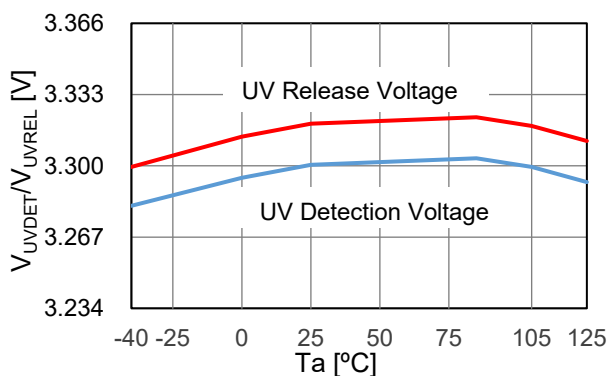

$V_{OVSET} = 3.7\text{ V}$

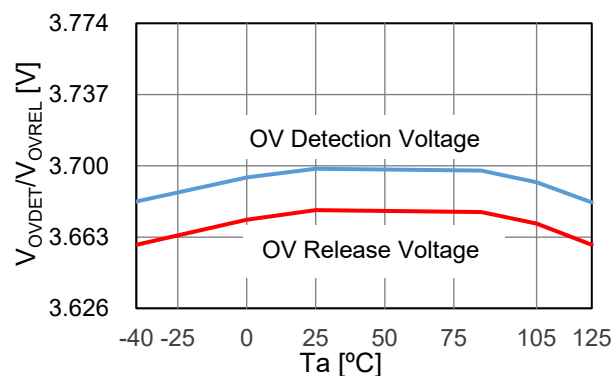

$V_{UVSET} = 0.55\text{ V}$

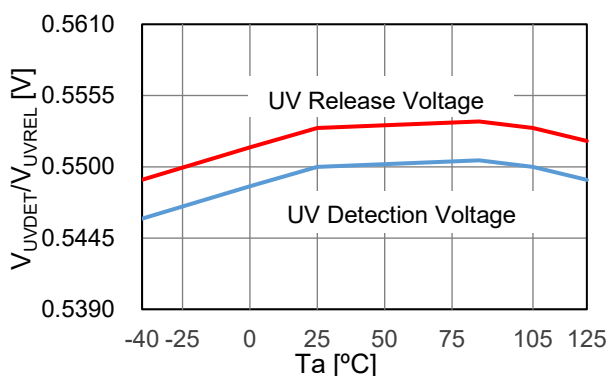

$V_{OVSET} = 0.75\text{ V}$

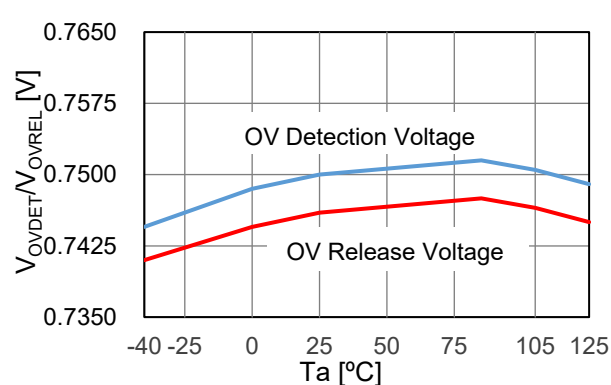

$V_{UVSET} = 3.15\text{ V}$

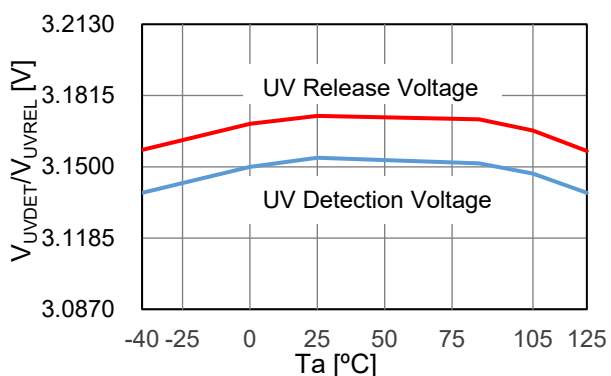

$V_{OVSET} = 3.45\text{ V}$

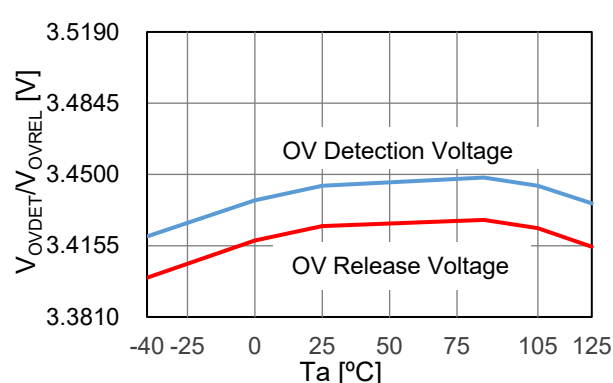

2) UV/OV Detection Voltage vs. Input Voltage

$V_{DD} = 14\text{ V}$,
 $V_{UVSET} = 3.3\text{ V}$

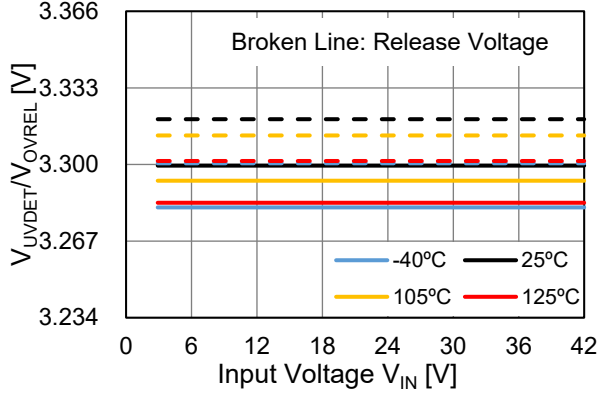

$V_{OVSET} = 3.7\text{ V}$

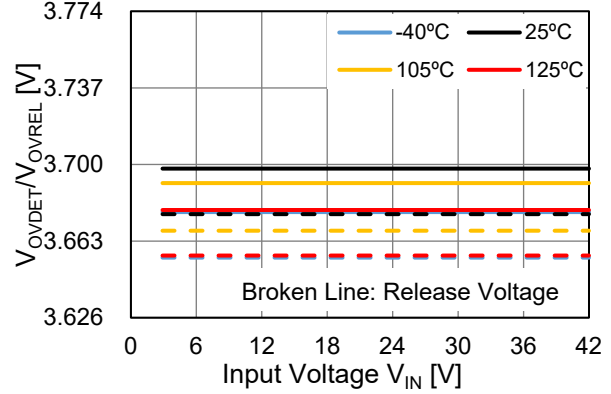

$V_{UVSET} = 0.55\text{ V}$

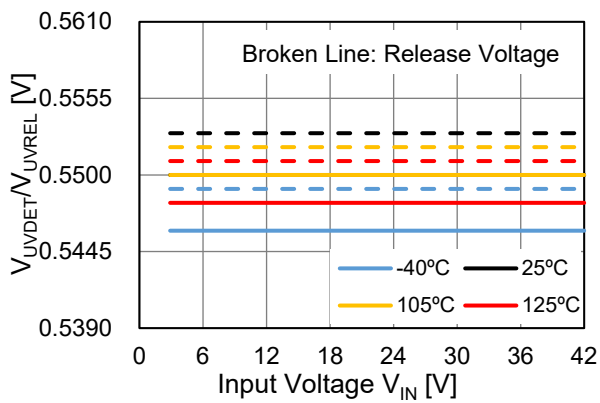

$V_{OVSET} = 0.75\text{ V}$

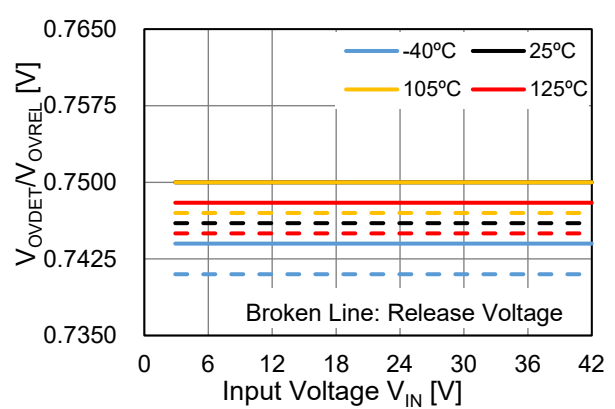

$V_{UVSET} = 3.15\text{ V}$

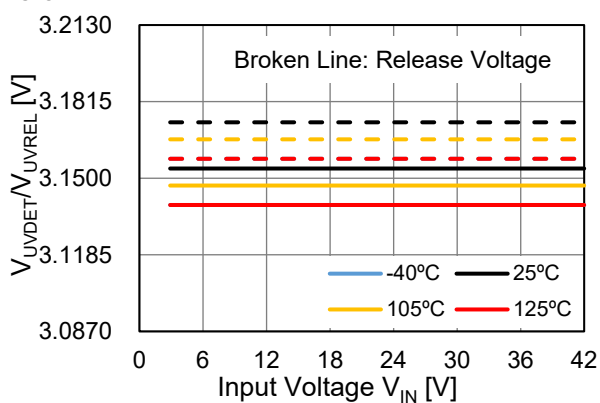

$V_{OVSET} = 3.45\text{ V}$

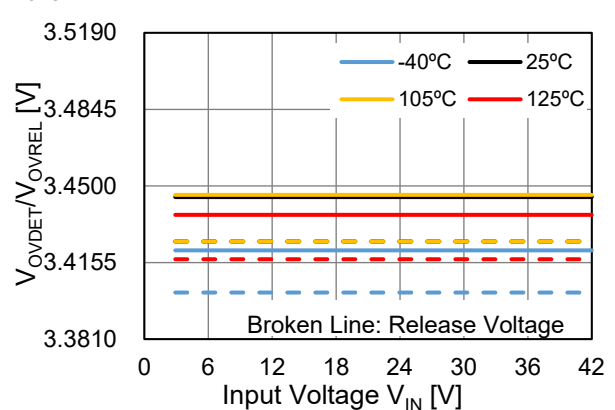

3) Supply Current vs. Input Voltage

$V_{UVSET} = 3.3 \text{ V} / V_{OVSET} = 3.7 \text{ V}, V_{SENSE} = 3.5 \text{ V}$

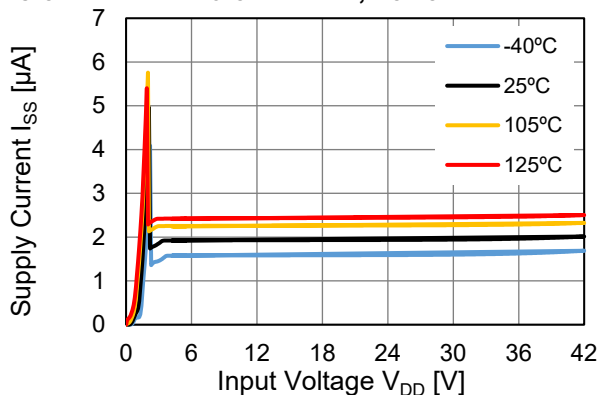

4) Supply Current vs. V_{SENSE}

$V_{UVSET} = 3.3 \text{ V} / V_{OVSET} = 3.7 \text{ V}, V_{DD} = 14 \text{ V}$

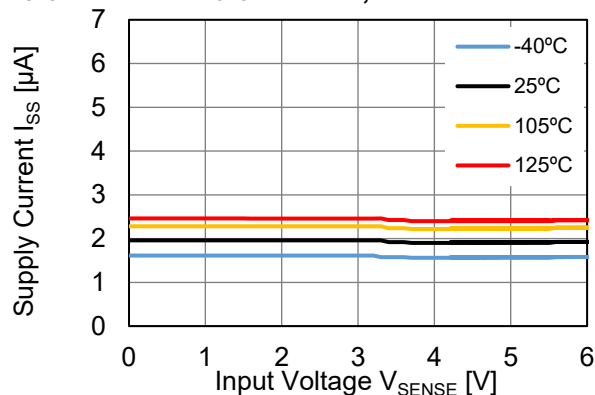

5) DOUT Pin Voltage vs. Input Voltage

$V_{UVSET} = 3.3 \text{ V} / V_{OVSET} = 3.7 \text{ V}, V_{SENSE} = 3.5 \text{ V}, T_a = 25^\circ\text{C}$

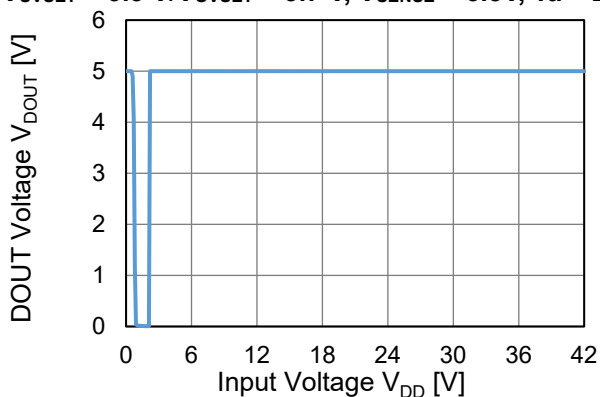

6) DOUT Pin Voltage vs. V_{SENSE}

$V_{DD} = 14 \text{ V}, T_a = 25^\circ\text{C}$

$V_{UVSET} = 3.3 \text{ V} / V_{OVSET} = 3.7 \text{ V}$

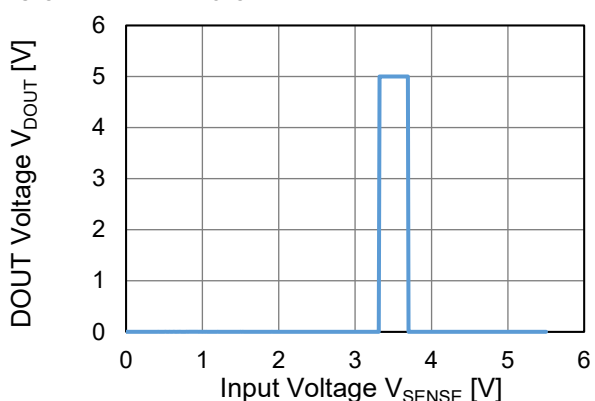

$V_{UVSET} = 0.55 \text{ V} / V_{OVSET} = 0.75 \text{ V}$

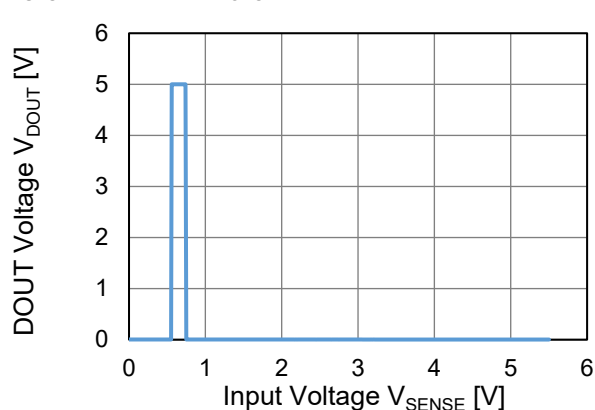

7) Driver Output Current vs. Input Voltage

$V_{SENSE} = 0\text{ V}$, $D_{OUT} = 0.1\text{ V}$

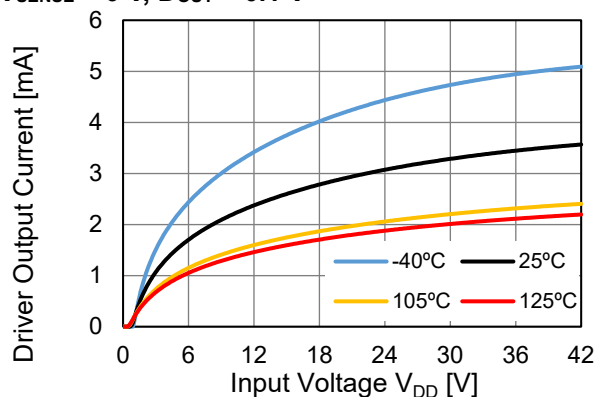

8) Driver Output Current vs. DOUT Pin Voltage

$V_{SENSE} = 0\text{ V}$, $T_a = 25^\circ\text{C}$

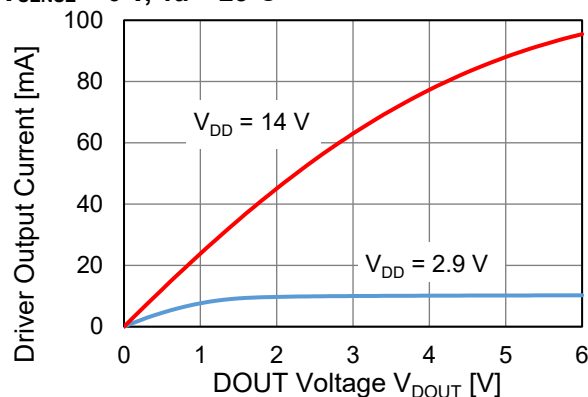

9) Release Delay Time vs. Temperature

$V_{UVSET} = 3.3\text{ V}$ / $V_{OVSET} = 3.7\text{ V}$, $V_{DD} = 14\text{ V}$, $C_D = 10\text{ nF}$

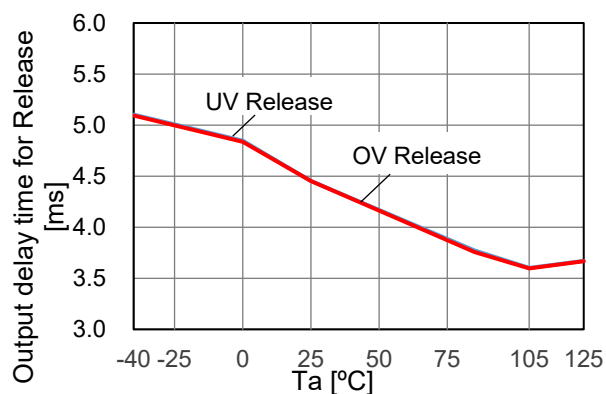

10) Release Delay Time vs. External Capacitor for CD Pin

$V_{UVSET} = 3.3\text{ V}$ / $V_{OVSET} = 3.7\text{ V}$, $V_{DD} = 14\text{ V}$, $T_a = 25^\circ\text{C}$

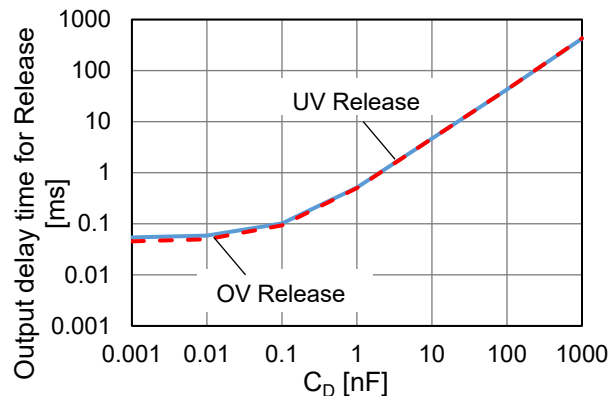

11) Release Delay Time vs. Input Voltage

$C_D = 10\text{ nF}$

$V_{SENSE} = 0\text{ V} \rightarrow (V_{UVSET} + V_{OVSET}) / 2$

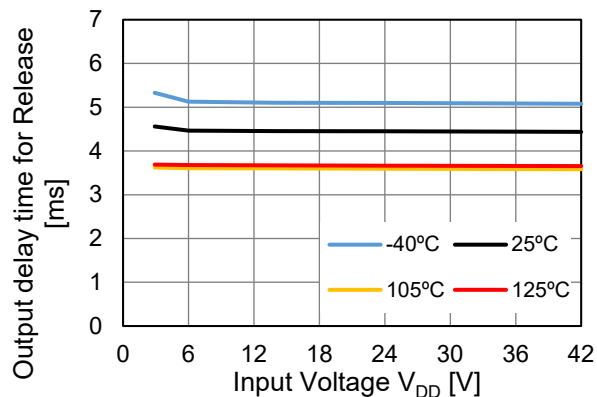

$V_{SENSE} = 5.5\text{ V} \rightarrow (V_{UVSET} + V_{OVSET}) / 2$

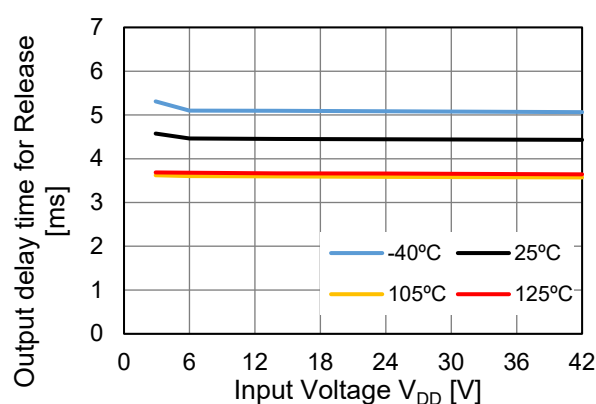

12) Detection Delay Time vs. Temperature

$V_{DD} = 14\text{ V}$, $V_{UVSET} = 3.3\text{ V}$ / $V_{OVSET} = 3.7\text{ V}$
 $V_{SENSE} = 3.5\text{ V} \rightarrow 0\text{ V (UV)}$, $3.5\text{ V} \rightarrow 5.5\text{ V (OV)}$

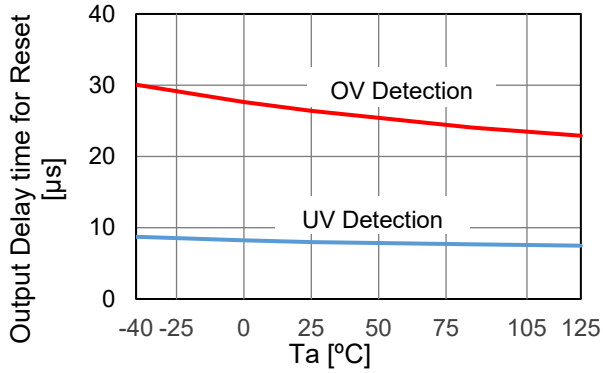

$V_{SENSE} = 3.5\text{ V} \rightarrow 3.2\text{ V (UV)}$, $3.5\text{ V} \rightarrow 3.81\text{ V (OV)}$

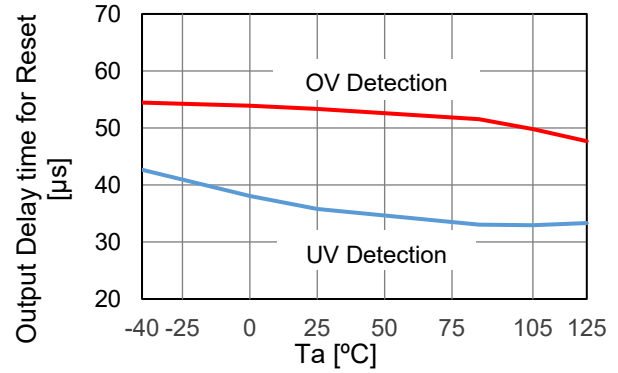

13) SENSE Pulse Width vs. Over Drive Voltage

$V_{DD} = 14\text{ V}$, $V_{UVSET} = 3.3\text{ V}$ / $V_{OVSET} = 3.7\text{ V}$, $T_a = 25^\circ\text{C}$

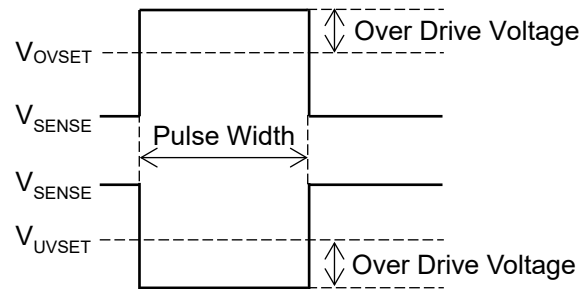
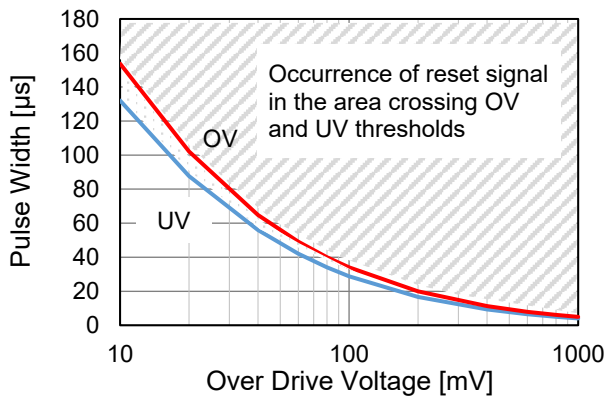

14) Load Dump

$V_{UVSET} = 3.3\text{ V}$ / $V_{OVSET} = 3.7\text{ V}$, $V_{SENSE} = 3.5\text{ V}$, $T_a = 25^\circ\text{C}$

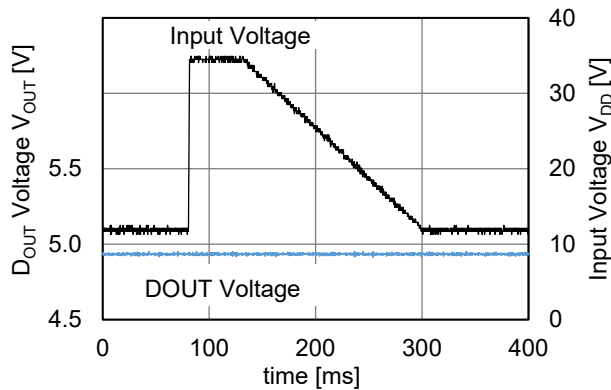

15) Cranking

$V_{UVSET} = 3.3\text{ V}$ / $V_{OVSET} = 3.7\text{ V}$, $V_{SENSE} = 3.5\text{ V}$, $T_a = 25^\circ\text{C}$

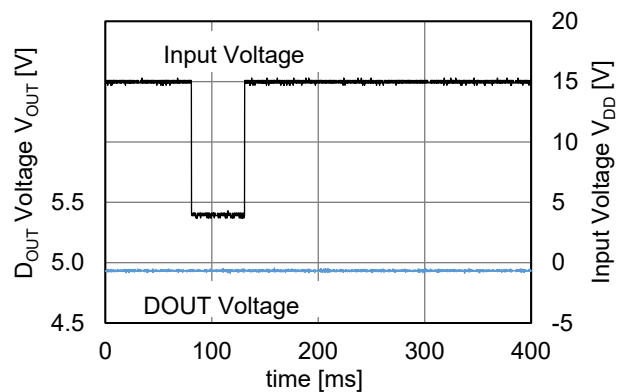

The power dissipation of the package is dependent on PCB material, layout, and environmental conditions. The following measurement conditions are based on JEDEC STD. 51-7.

Measurement Conditions

Item	Measurement Conditions
Environment	Mounting on Board (Wind Velocity = 0 m/s)
Board Material	Glass Cloth Epoxy Plastic (Four-Layer Board)
Board Dimensions	76.2 mm × 114.3 mm × 0.8 mm
Copper Ratio	Outer Layer (First Layer): Less than 95% of 50 mm Square Inner Layers (Second and Third Layers): Approx. 100% of 50 mm Square Outer Layer (Fourth Layer): Approx. 100% of 50 mm Square
Through-holes	φ 0.3 mm × 7 pcs

Measurement Result

(Ta = 25°C, Tjmax = 150°C)

Item	Measurement Result
Power Dissipation	830 mW
Thermal Resistance (θja)	θja = 150°C/W
Thermal Characterization Parameter (ψjt)	ψjt = 51°C/W

θja: Junction-to-Ambient Thermal Resistance

ψjt: Junction-to-Top Thermal Characterization Parameter

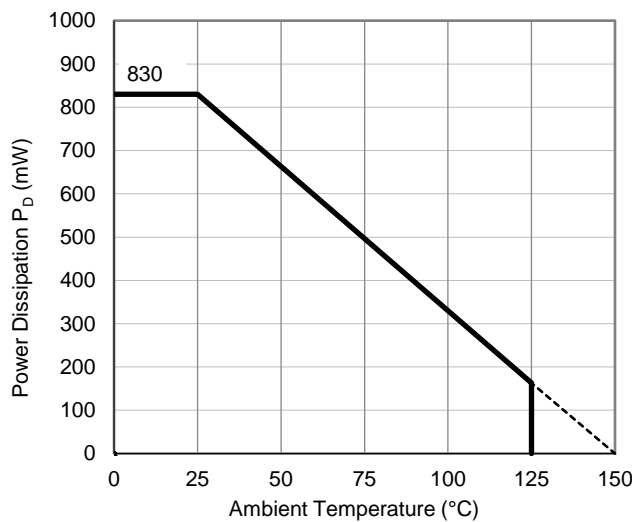

Power Dissipation vs. Ambient Temperature

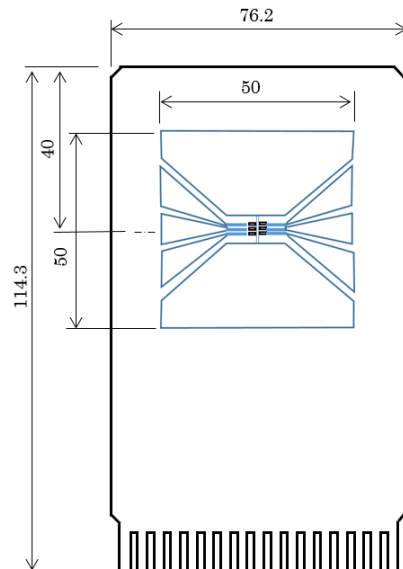

Measurement Board Pattern

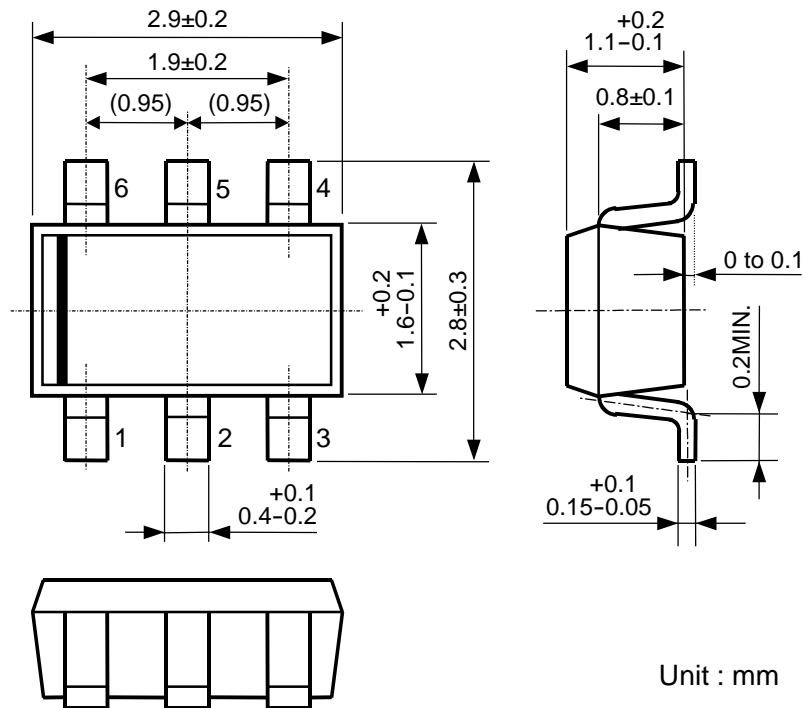

SOT-23-6 Package Dimensions (Unit: mm)



1. The products and the product specifications described in this document are subject to change or discontinuation of production without notice for reasons such as improvement. Therefore, before deciding to use the products, please refer to Ricoh sales representatives for the latest information thereon.
2. The materials in this document may not be copied or otherwise reproduced in whole or in part without prior written consent of Ricoh.
3. Please be sure to take any necessary formalities under relevant laws or regulations before exporting or otherwise taking out of your country the products or the technical information described herein.
4. The technical information described in this document shows typical characteristics of and example application circuits for the products. The release of such information is not to be construed as a warranty of or a grant of license under Ricoh's or any third party's intellectual property rights or any other rights.
5. The products in this document are designed for automotive applications. However, when using the products for automotive applications, please make sure to contact Ricoh sales representative in advance due to confirming the quality level.
6. We are making our continuous effort to improve the quality and reliability of our products, but semiconductor products are likely to fail with certain probability. In order to prevent any injury to persons or damages to property resulting from such failure, customers should be careful enough to incorporate safety measures in their design, such as redundancy feature, fire containment feature and fail-safe feature. We do not assume any liability or responsibility for any loss or damage arising from misuse or inappropriate use of the products.
7. Anti-radiation design is not implemented in the products described in this document.
8. The X-ray exposure can influence functions and characteristics of the products. Confirm the product functions and characteristics in the evaluation stage.
9. WLCSP products should be used in light shielded environments. The light exposure can influence functions and characteristics of the products under operation or storage.
10. There can be variation in the marking when different AOI (Automated Optical Inspection) equipment is used.
In the case of recognizing the marking characteristic with AOI, please contact Ricoh sales or our distributor before attempting to use AOI.
11. Please contact Ricoh sales representatives should you have any questions or comments concerning the products or the technical information.



Ricoh is committed to reducing the environmental loading materials in electrical devices with a view to contributing to the protection of human health and the environment.

Ricoh has been providing RoHS compliant products since April 1, 2006 and Halogen-free products since April 1, 2012.

RICOH RICOH ELECTRONIC DEVICES CO., LTD.

Official website

<https://www.n-redc.co.jp/en/>

Contact us

<https://www.n-redc.co.jp/en/buy/>

