Up to 6 GHz Low Noise Silicon Bipolar Transistor

Technical Data

AT-41470

Features

- **Low Noise Figure:**
 - 1.6 dB Typical at 2.0 GHz
 - 3.0 dB Typical at 4.0 GHz
- **High Associated Gain:**
 - 14.5 dB Typical at 2.0 GHz
 - 10.5 dB Typical at 4.0 GHz
- **High Gain-Bandwidth Product:** 8.0 GHz Typical f_T
- **Hermetic, Gold-ceramic Microstrip Package**

Description

Hewlett-Packard's AT-41470 is a general purpose NPN bipolar transistor that offers excellent high frequency performance. The AT-41470 is housed in a hermetic, high reliability gold-ceramic 70 mil microstrip package. The 4 micron emitter-to-emitter pitch enables this transistor to be used in many different functions. The 14 emitter

finger interdigitated geometry yields an intermediate sized transistor with impedances that are easy to match for low noise and moderate power applications. This device is designed for use in low noise, wideband amplifier, mixer and oscillator applications in the VHF, UHF, and microwave frequencies. An optimum noise match near 50Ω at 1 GHz, makes this device easy to use as a low noise amplifier.

The AT-41470 bipolar transistor is fabricated using Hewlett-Packard's 10 GHz f_T Self-Aligned-Transistor (SAT) process. The die is nitride passivated for surface protection. Excellent device uniformity, performance and reliability are produced by the use of ion-implantation, self-alignment techniques, and gold metalization in the fabrication of this device.

70 mil Package

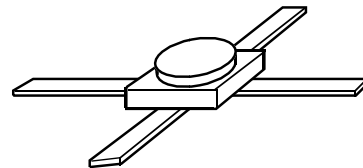

AT-41470 Absolute Maximum Ratings

Symbol	Parameter	Units	Absolute Maximum ^[1]
V _{EBO}	Emitter-Base Voltage	V	1.5
V _{CBO}	Collector-Base Voltage	V	20
V _{CEO}	Collector-Emitter Voltage	V	12
I _C	Collector Current	mA	60
P _T	Power Dissipation ^[2,3]	mW	500
T _j	Junction Temperature	°C	200
T _{STG}	Storage Temperature	°C	-65 to 200

Thermal Resistance^[2,4]:

$$\theta_{jc} = 175^{\circ}\text{C/W}$$

Notes:

1. Permanent damage may occur if any of these limits are exceeded.
2. T_{CASE} = 25°C.
3. Derate at 5.7 mW/°C for T_C > 113°C.
4. The small spot size of this technique results in a higher, though more accurate determination of θ_{jc} than do alternate methods. See MEASUREMENTS section "Thermal Resistance" for more information.

Electrical Specifications, T_A = 25°C

Symbol	Parameters and Test Conditions	Units	Min.	Typ.	Max.
S _{21E} ²	Insertion Power Gain; V _{CE} = 8 V, I _C = 25 mA	f = 2.0 GHz f = 4.0 GHz	dB	12.0 6.5	
P _{1dB}	Power Output @ 1 dB Gain Compression V _{CE} = 8 V, I _C = 25 mA	f = 2.0 GHz f = 4.0 GHz	dBm	19.0 18.5	
G _{1dB}	1 dB Compressed Gain; V _{CE} = 8 V, I _C = 25 mA	f = 2.0 GHz f = 4.0 GHz	dB	15.0 10.5	
NF _O	Optimum Noise Figure; V _{CE} = 8 V, I _C = 10 mA	f = 1.0 GHz f = 2.0 GHz f = 4.0 GHz	dB	1.3 1.6 3.0	1.9
G _A	Gain @ NF _O ; V _{CE} = 8 V, I _C = 10 mA	f = 1.0 GHz f = 2.0 GHz f = 4.0 GHz	dB	13.0 18.5 14.5 10.5	
f _T	Gain Bandwidth Product; V _{CE} = 8 V, I _C = 25 mA		GHz	8.0	
h _{FE}	Forward Current Transfer Ratio; V _{CE} = 8 V, I _C = 10 mA		—	30	300
I _{CBO}	Collector Cutoff Current; V _{CB} = 8 V		μA		0.2
I _{EBO}	Emitter Cutoff Current; V _{EB} = 1 V		μA		1.0
C _{CB}	Collector Base Capacitance ^[1] ; V _{CB} = 8 V, f = 1 MHz		pF	0.2	

Note:

1. For this test, the emitter is grounded.

AT-41470 Typical Performance, $T_A = 25^\circ\text{C}$

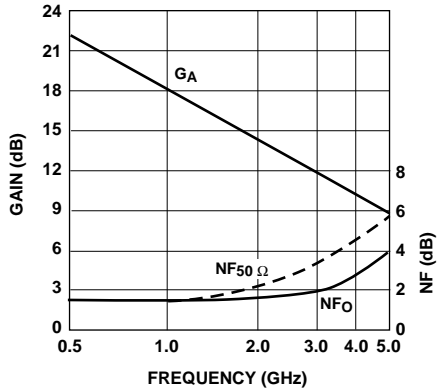

Figure 1. Noise Figure and Associated Gain vs. Frequency.
 $V_{CE} = 8\text{ V}$, $I_C = 10\text{ mA}$.

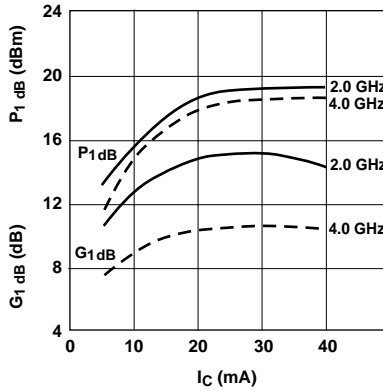

Figure 2. Output Power and 1 dB Compressed Gain vs. Collector Current and Frequency. $V_{CE} = 8\text{ V}$.

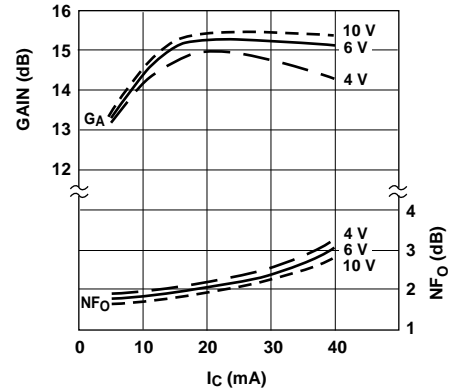

Figure 3. Optimum Noise Figure and Associated Gain vs. Collector Current and Collector Voltage. $f = 2.0\text{ GHz}$.

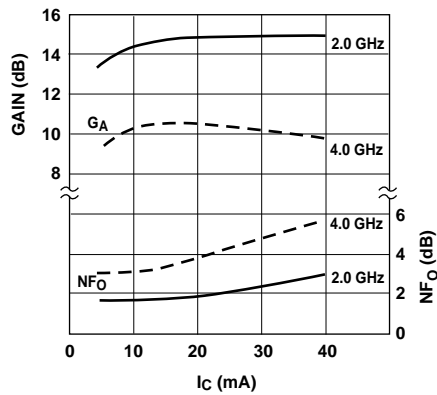

Figure 4. Optimum Noise Figure and Associated Gain vs. Collector Current and Frequency. $V_{CE} = 8\text{ V}$.

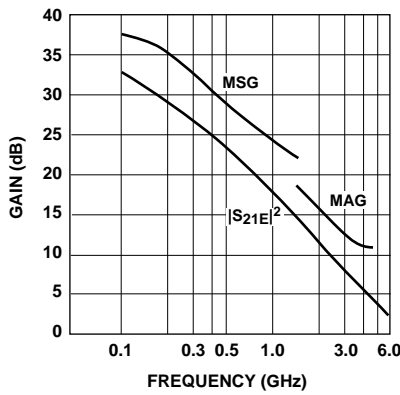

Figure 5. Insertion Power Gain, Maximum Available Gain and Maximum Stable Gain vs. Frequency.
 $V_{CE} = 8\text{ V}$, $I_C = 25\text{ mA}$.

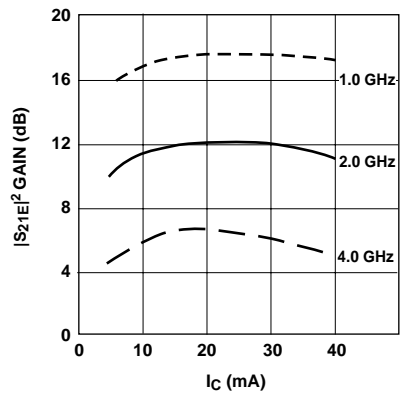

Figure 6. Insertion Power Gain vs. Collector Current and Frequency. $V_{CE} = 8\text{ V}$.

AT-41470 Typical Scattering Parameters,

Common Emitter, $Z_0 = 50 \Omega$, $T_A = 25^\circ\text{C}$, $V_{CE} = 8\text{V}$, $I_C = 10\text{mA}$

Freq. GHz	S_{11}		dB	S_{21}		dB	S_{12}		S_{22}	
	Mag.	Ang.		Mag.	Ang.		Mag.	Ang.	Mag.	Ang.
0.1	.79	-37	28.4	26.27	157	-39.2	.011	57	.94	-13
0.5	.65	-120	22.3	13.05	110	-30.8	.029	40	.62	-30
1.0	.61	-155	17.1	7.17	88	-28.9	.036	41	.52	-32
1.5	.60	-172	13.9	4.93	76	-27.5	.042	46	.50	-36
2.0	.60	176	11.5	3.75	65	-26.4	.048	46	.50	-40
2.5	.61	169	9.7	3.06	59	-26.0	.050	58	.48	-41
3.0	.62	161	8.3	2.59	51	-24.7	.058	61	.49	-48
3.5	.61	154	7.0	2.24	42	-23.2	.069	63	.51	-56
4.0	.60	146	5.9	1.97	32	-21.4	.085	62	.52	-63
4.5	.60	137	4.9	1.77	24	-20.1	.099	59	.55	-69
5.0	.60	127	4.1	1.61	15	-19.5	.106	59	.57	-75
5.5	.61	115	3.4	1.47	6	-18.3	.121	56	.58	-80
6.0	.64	104	2.6	1.34	-4	-17.4	.135	53	.57	-87

AT-41470 Typical Scattering Parameters,

Common Emitter, $Z_0 = 50 \Omega$, $T_A = 25^\circ\text{C}$, $V_{CE} = 8\text{V}$, $I_C = 25\text{mA}$

Freq. GHz	S_{11}		dB	S_{21}		dB	S_{12}		S_{22}	
	Mag.	Ang.		Mag.	Ang.		Mag.	Ang.	Mag.	Ang.
0.1	.64	-62	32.5	42.11	147	-40.9	.009	75	.85	-19
0.5	.61	-146	23.7	15.31	100	-34.4	.019	47	.50	-30
1.0	.61	-170	18.1	8.00	83	-30.2	.031	53	.44	-31
1.5	.60	177	14.7	5.42	72	-29.1	.035	62	.44	-34
2.0	.61	167	12.3	4.10	62	-27.1	.044	60	.44	-39
2.5	.61	163	10.4	3.32	58	-25.7	.052	67	.43	-39
3.0	.62	156	9.0	2.81	50	-23.6	.066	67	.44	-46
3.5	.62	150	7.7	2.44	41	-22.6	.074	67	.46	-55
4.0	.62	142	6.6	2.13	32	-21.7	.082	63	.48	-62
4.5	.61	134	5.6	1.91	24	-20.1	.099	62	.50	-68
5.0	.60	123	4.8	1.73	15	-18.9	.113	59	.52	-73
5.5	.61	112	4.0	1.59	6	-18.1	.124	54	.54	-78
6.0	.64	102	3.2	1.45	-3	-17.3	.136	50	.53	-85

A model for this device is available in the DEVICE MODELS section.

AT-41470 Noise Parameters: $V_{CE} = 8\text{V}$, $I_C = 10\text{mA}$

Freq. GHz	NF_0 dB	Γ_{opt}		$R_N/50$
		Mag	Ang	
0.1	1.2	.12	5	0.17
0.5	1.2	.11	17	0.17
1.0	1.3	.06	35	0.17
2.0	1.6	.21	160	0.16
4.0	3.0	.45	-150	0.20

70 mil Package Dimensions

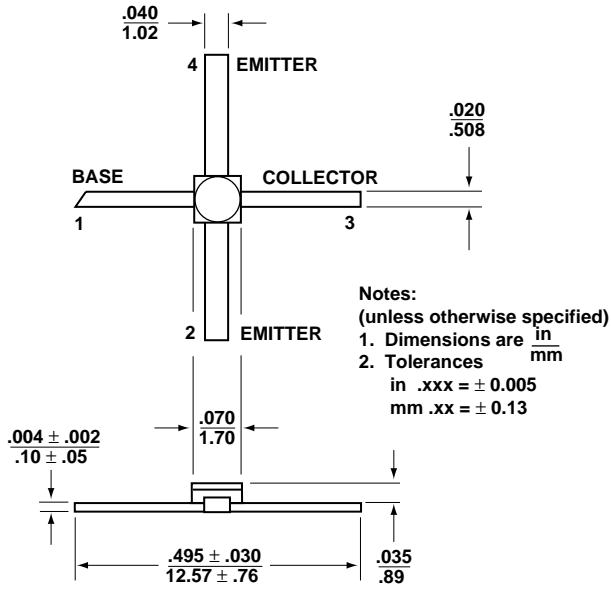

Package marking is "414"