



PRODUCT SPECIFICATION

Part Number

PT482743A-TLMWD-EM10

CUSTOMER	
CUSTOMER PART NUMBER	
DESCRIPTION	4.3" TFT LCD, Medium Bright
APPROVED BY	
DATE	

**P-TEC****MODEL NO.****PAGE**

PT482743A-TLMWD-EM10

SPEC SAMPLE

2/29

1. Table of Contents

No.	Contents	Page
1	Table of Contents	2
2	Record of Revisions	3
3	Module Numbering System	4
4	Application	5
5	Features	5
6	General Specifications	5
7	Absolute Maximum Ratings	6
8	Electrical Characteristics	7
9	Block Diagram	9
10	Input / Output Terminals Pin Assignment	10
11	Interface Timing	13
12	Optical Characteristics	15
13	Reliability Test	18
14	Packaging	19
15	Precautions	20
16	Outline Drawing	21
17	Definition of Labels	23
18	Incoming Inspection Standards	25



3. Module Numbering System

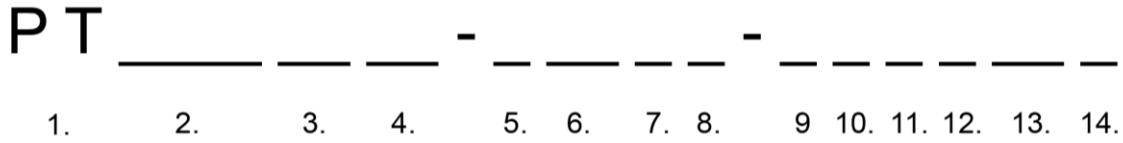

1. P-TEC TFT

2. LENGTH x WIDTH PIXELS

If third character is a zero, it is removed to shorten part number. Example: 240 x 320 = PT3224

3. DIAGONAL DIMENSIONS

Example: 3.5" display = 35 in part number

4. PRODUCT VERSION

Series assigned by P-tec

5. LCD MODE

T: TN
I: IPS
V: VA

6. POLARIZER

LM: Transmissive
LF: Transflective

7. BACKLIGHT COLOR

No Backlight: Left Blank
W: White
B: Blue/Green
S: Yellow/Green

8. VIEWING DIRECTION

D: 6 o'clock
U: 12 o'clock
F: Full Viewing Angle

9. A ~ Z CODE

Assigned by P-tec

11. TEMPERATURE RANGE

Normal: Left Blank
Wide: X

12. LUMINANCE

Blank: Normal (<300 nit)
M: Middle (>= 300 nit)
H: High (> 600 nit)

13. TOUCH PANEL OPTION

No TP: Left Blank
C: Capacitive TP
R: Resistive TP

14. SPECIAL CHARACTERS

Customer special requirements

**4. Application**

This specification is applied to the 4.3 inch supported TFT-LCD module, and can display true 16.7M colors(8 bit/ color).The module is designed for PMP, GPS application and other electronic products which require flat panel display of digital signal interface. The model is composed of a TFT LCD panel, a driver circuit and a back-light system.

5. Features

- WQVGA (480×272 pixels) resolution.
- 24 bit parallel RGB.

6. General Specifications

Item	Specifications	Unit
Screen Size	4.3 (Diagonal)	inch
Display Format	480RGB(H)×272(V)	dot
Active Area	95.04(H)×53.856(V)	mm
PIXEL Pitch	0.198(H)×0.198(V)	mm
Pixel Configuration	RGB Vertical Stripe	-
Display Mode	TN Type Transmissive Mode Normally White	-
Surface Treatment	Anti-Glare and Hard Coating(3H)	-
Viewing Direction	6 O'clock (The Gray Inversion will appear at this direction)	-
Outline Dimension	105.5(W)×67.2(H)×3.95(D)	mm
Weight	(43.5)	g
RoHS Compliance	P-tec certifies this product to be in compliance with European Union Directive 2002/95/EC on the restriction of certain hazardous substances in electrical and electronic equipment.	-



7. Absolute Maximum Ratings

7.1 Absolute Ratings of Environment

Item	Symbol	Value		Unit	Note
		Min.	Max.		
Storage Temperature	T _{ST}	-30	+80	°C	(1)
Operating Ambient Temperature	T _{OP}	-20	+70	°C	(1)

Note (1) Temperature and relative humidity range are shown in the figure below.

(a) 95%RH Max. ($T_a \leq 50^\circ\text{C}$).

(b) Wet-bulb temperature should be 39°C Max. ($T_a > 50^\circ\text{C}$).

(c) No condensation.

7.2 Electrical Absolute Ratings

7.2.1 TFT-LCD Module

($T_a = 25 \pm 2^\circ\text{C}$, $V_{SS} = 0\text{V}$)

Item	Symbol	Value		Unit	Note
		Min.	Max.		
Digital Power Supply Voltage	DVDD	-0.3	4.0	V	-

7.2.2 Backlight Unit

($T_a = 25 \pm 2^\circ\text{C}$)

Item	Symbol	Value		Unit	Note
		Min.	Max.		
Current of Backlight Unit	I _B	-	30	mA	(1)
Reverse Voltage	V _R	-	35	V	(1)

Note (1) Permanent damage to the device may occur if maximum values are exceeded or reverse voltage is loaded.



8. Electrical Characteristics

8.1 TFT-LCD Module

(Ta=25±2°C)

Item	Symbol	Value			Unit	Note
		Min.	Typ.	Max.		
Digital Power Supply Voltage	DVDD	3	3.3	3.6	V	-
Input High Threshold Voltage	VIH	0.7DVDD	-	DVDD	V	-
Input Low Threshold Voltage	VIL	0	-	0.3 DVDD	V	-
Vsync Frequency	F _V	-	59.94	-	Hz	-
Hsync Frequency	F _H	-	17.14	-	KHz	-
Dot Clock	DCLK	-	9.0	15.0	MHz	-

(VSS = 0V)

Parameter	SYMBOL	Condition	Min.	Typ.	Max.	Unit	Remarks
Digital Current	IDVDD	DVDD=3.3V	-	22.8	31.92	mA	(1)
Total Power Consumption	PC	-	-	75.24	105.34	mW	(1)

Note (1) The specified power consumption is under the conditions at DVDD = 3.3V, FV=60Hz, DCLK=9.0 MHz, whereas a power dissipation check Pattern below is displayed.

Black Pattern / 0 Gray

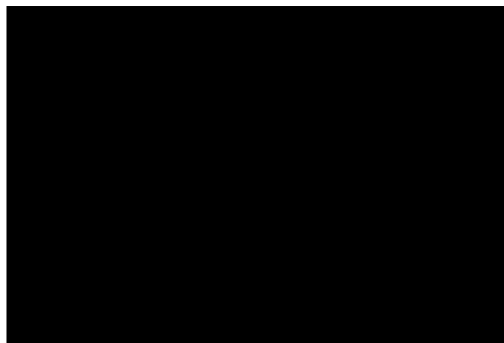

Active Area

**8.2 Backlight Unit**

(Ta=25±2°C)

Item	Symbol	Value			Unit	Note
		Min.	Typ.	Max.		
LED Voltage	VL	-	(23.1)	-	V	(1)
Current of Backlight Unit	I _B	-	20	-	mA	(1)
Power Consumption	P _{BL}	-	(462)	-	mW	(1)
LED life time	-	10000	-	-	Hr	(2)

Note (1) The driving design of backlight unit is dependent on serial consideration of 7 LEDs.

(2) The LED life time is defined as the module brightness decrease to 50%, original brightness at Ta=25°C, I_B =20mA.



9. Block Diagram TFT-LCD Module with Backlight Unit

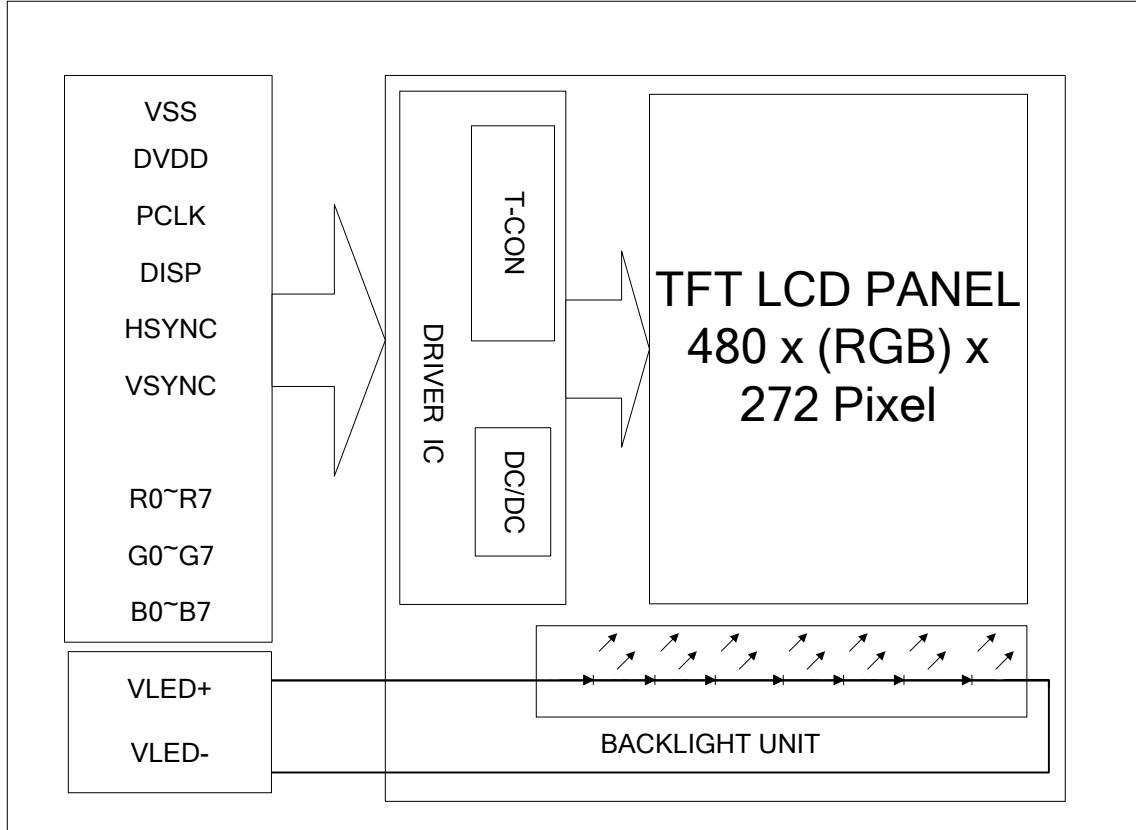



10. Input / Output Terminals Pin Assignment

10.1 TFT-LCD Module

(Reference Connector :

Hirose Electric CO., LTD. Product No.: FH12A-40S-0.5SH(55) Top contact type)

Pin No.	Symbol	Description	Pin No.	Symbol	Description
1	VSS	Ground	21	B0	Blue data(LSB)
2	VSS	Ground	22	B1	Blue data
3	DVDD	POWER SUPPLY(+3.3V)	23	B2	Blue data
4	DVDD	POWER SUPPLY(+3.3V)	24	B3	Blue data
5	R0	Red data(LSB)	25	B4	Blue data
6	R1	Red data	26	B5	Blue data
7	R2	Red data	27	B6	Blue data
8	R3	Red data	28	B7	Blue data(MSB)
9	R4	Red data	29	VSS	Ground
10	R5	Red data	30	PCLK	Pixel clock
11	R6	Red data	31	DISP	Display ON/OFF Signal
12	R7	Red data(MSB)	32	HSYNC	Horizontal Sync input with negative polarity
13	G0	Green data(LSB)	33	VSYNC	Vertical Sync input with negative polarity
14	G1	Green data	34	NC	NC
15	G2	Green data	35	NC	NC
16	G3	Green data	36	NC	NC
17	G4	Green data	37	NC	NC
18	G5	Green data	38	NC	NC
19	G6	Green data	39	NC	NC
20	G7	Green data(MSB)	40	NC	NC



P-TEC

MODEL NO.

PAGE

PT482743A-TLMWD-EM10

SPEC SAMPLE

11/29

10.2 Backlight

(Reference Connector :

Kyocera Elco Corporation Product No. : 6298 Bottom contact type)

Terminal No.	Signal	Functions
1	VLED-	LED Power Source Input terminal (Cathode side)
2	NC	No Connection
3	NC	No Connection
4	VLED+	LED Power Source Input terminal (Anode side)



10.3 Color Data Input Assignment

The brightness of each primary color(red, green and blue) is based on the 8 bit gray scale data input for the color. The higher the binary input, the brighter the color. The table provides the assignment of color versus data input.

Color		Data Signal																							
		Red								Green								Blue							
		R7	R6	R5	R4	R3	R2	R1	R0	G7	G6	G5	G4	G3	G2	G1	G0	B7	B6	B5	B4	B3	B2	B1	B0
Basic Colors	Black	0	0	0	0	0	0	0	0	0	0	0	0	0	0	0	0	0	0	0	0	0	0	0	
	Red	1	1	1	1	1	1	1	1	0	0	0	0	0	0	0	0	0	0	0	0	0	0	0	
	Green	0	0	0	0	0	0	0	0	1	1	1	1	1	1	1	1	0	0	0	0	0	0	0	
	Blue	0	0	0	0	0	0	0	0	0	0	0	0	0	0	0	0	1	1	1	1	1	1	1	
	Cyan	0	0	0	0	0	0	0	0	1	1	1	1	1	1	1	1	1	1	1	1	1	1	1	
	Magenta	1	1	1	1	1	1	1	1	0	0	0	0	0	0	0	0	1	1	1	1	1	1	1	
	Yellow	1	1	1	1	1	1	1	1	1	1	1	1	1	1	1	1	0	0	0	0	0	0	0	
	White	1	1	1	1	1	1	1	1	1	1	1	1	1	1	1	1	1	1	1	1	1	1	1	
Gray Scale Of RED	Red(0) / Dark	0	0	0	0	0	0	0	0	0	0	0	0	0	0	0	0	0	0	0	0	0	0		
	Red(1)	0	0	0	0	0	0	1	0	0	0	0	0	0	0	0	0	0	0	0	0	0	0		
	Red(2)	0	0	0	0	0	0	1	0	0	0	0	0	0	0	0	0	0	0	0	0	0	0		
	:	:	:	:	:	:	:	:	:	:	:	:	:	:	:	:	:	:	:	:	:	:	:		
	:	:	:	:	:	:	:	:	:	:	:	:	:	:	:	:	:	:	:	:	:	:	:		
	:	:	:	:	:	:	:	:	:	:	:	:	:	:	:	:	:	:	:	:	:	:	:		
	Red(253)	1	1	1	1	1	1	0	1	0	0	0	0	0	0	0	0	0	0	0	0	0	0		
	Red(254)	1	1	1	1	1	1	1	0	0	0	0	0	0	0	0	0	0	0	0	0	0	0		
Red(255)	1	1	1	1	1	1	1	1	0	0	0	0	0	0	0	0	0	0	0	0	0	0			
Gray Scale Of Green	Green(0) / Dark	0	0	0	0	0	0	0	0	0	0	0	0	0	0	0	0	0	0	0	0	0	0		
	Green(1)	0	0	0	0	0	0	0	0	0	0	0	0	0	0	1	0	0	0	0	0	0	0		
	Green(2)	0	0	0	0	0	0	0	0	0	0	0	0	0	0	1	0	0	0	0	0	0	0		
	:	:	:	:	:	:	:	:	:	:	:	:	:	:	:	:	:	:	:	:	:	:	:		
	:	:	:	:	:	:	:	:	:	:	:	:	:	:	:	:	:	:	:	:	:	:	:		
	:	:	:	:	:	:	:	:	:	:	:	:	:	:	:	:	:	:	:	:	:	:	:		
	Green(253)	0	0	0	0	0	0	0	1	1	1	1	1	1	1	0	1	0	0	0	0	0	0		
	Green(254)	0	0	0	0	0	0	0	1	1	1	1	1	1	1	1	0	0	0	0	0	0	0		
Green(255)	0	0	0	0	0	0	0	1	1	1	1	1	1	1	1	1	0	0	0	0	0	0			
Gray Scale Of Blue	Blue(0) / Dark	0	0	0	0	0	0	0	0	0	0	0	0	0	0	0	0	0	0	0	0	0	0		
	Blue(1)	0	0	0	0	0	0	0	0	0	0	0	0	0	0	0	0	0	0	0	0	0	1		
	Blue(2)	0	0	0	0	0	0	0	0	0	0	0	0	0	0	0	0	0	0	0	0	0	1		
	:	:	:	:	:	:	:	:	:	:	:	:	:	:	:	:	:	:	:	:	:	:	:		
	:	:	:	:	:	:	:	:	:	:	:	:	:	:	:	:	:	:	:	:	:	:	:		
	:	:	:	:	:	:	:	:	:	:	:	:	:	:	:	:	:	:	:	:	:	:	:		
	Blue(253)	0	0	0	0	0	0	0	0	0	0	0	0	0	0	0	1	1	1	1	1	1	0		
	Blue(254)	0	0	0	0	0	0	0	0	0	0	0	0	0	0	0	1	1	1	1	1	1	0		
Blue(255)	0	0	0	0	0	0	0	0	0	0	0	0	0	0	0	1	1	1	1	1	1	1			



11. Interface Timing

11.1 Timing Requirement 1

Parameter	Symbol	Spec.			Unit
		Min.	Typ.	Max.	
Clock cycle	$f_{CLK}^{(1)}$	-	9	15	MHz
Hsync cycle	$1/th$	-	17.14	-	KHz
Vsync cycle	$1/tv$	-	59.94	-	Hz
Horizontal Signal					
Horizontal cycle	th	525	525	605	CLK
Horizontal display period	thd	480	480	480	CLK
Horizontal front porch	thf	2	2	82	CLK
Horizontal pulse width	thp ⁽²⁾	2	41	41	CLK
Horizontal back porch	thb ⁽²⁾	2	2	41	CLK
Vertical Signal					
Vertical cycle	tv	285	286	399	H ⁽¹⁾
Vertical display period	tvd	272	272	272	H ⁽¹⁾
Vertical front porch	tvf	1	2	227	H ⁽¹⁾
Vertical pulse width	tvp ⁽²⁾	1	10	11	H ⁽¹⁾
Vertical back porch	tvb ⁽²⁾	1	2	11	H ⁽¹⁾

Note: (1) Unit: CLK=1/ f_{CLK} , H= th,

(2) It is necessary to keep $tv_p+tv_b=12$ and $th_p+th_b=43$ in sync mode. DE mode is unnecessary to keep it.

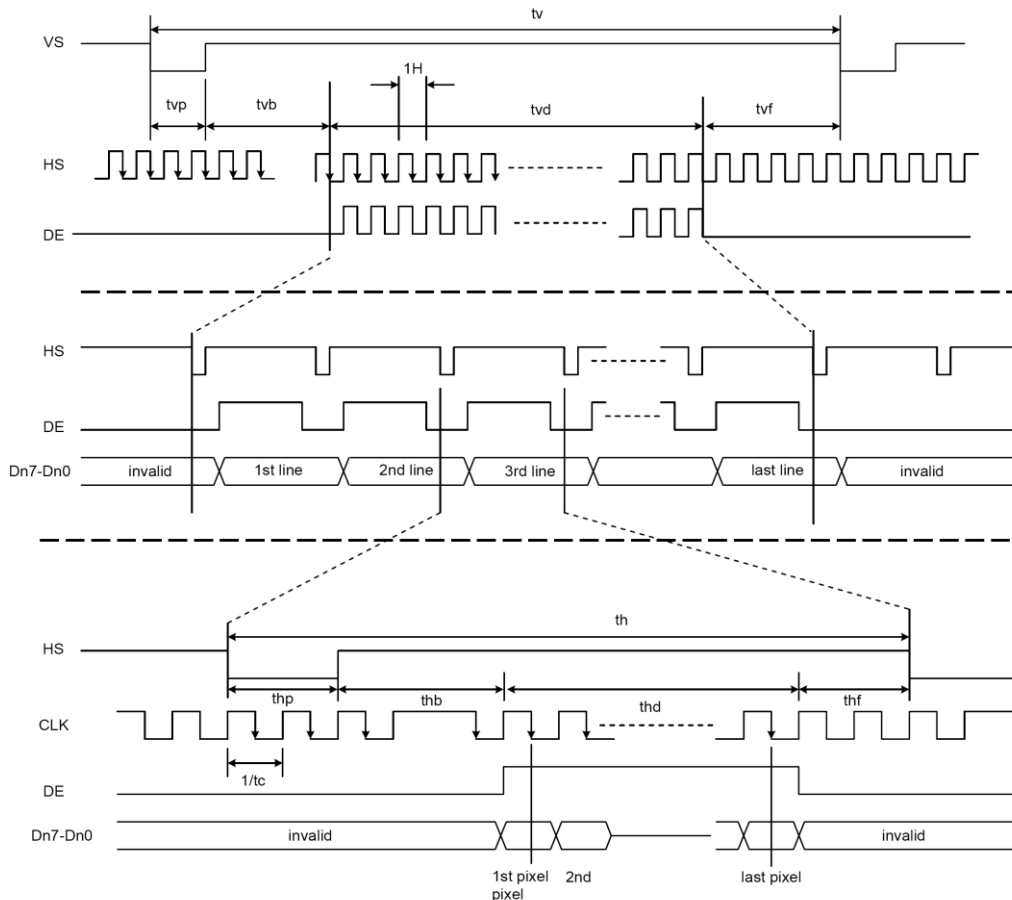

Figure 11.1 Input timing



11.2 Timing Requirement 2

(TA =25°C, VDDIO=3V to 3.6V, DVSS= 0V, tr (1)=tf (1)=2ns)

PARAMETER	Symbol	Min.	Typ.	Max.	Unit
DISP setup time	t_{diss}	10	-	-	ns
DISP hold time	t_{dish}	10	-	-	ns
Clock period	PW_{CLK}^{*1}	66.7	-	-	ns
Clock pulse high period	PWH^{*1}	26.7	-	-	ns
Clock pulse low period	PWL^{*1}	26.7	-	-	ns
Hsync setup time	t_{hs}	10	-	-	ns
Hsync hold time	t_{hh}	10	-	-	ns
Data setup time	t_{ds}	10	-	-	ns
Data hold time	t_{dh}	10	-	-	ns
Vsync setup time	t_{vhs}	10	-	-	ns
Vsync hold time	t_{vhh}	10	-	-	ns

Note:

1. For parallel interface, maximum clock frequency is 15MHz.
2. tr, tf is defined 10% to 90% of signal amplitude.

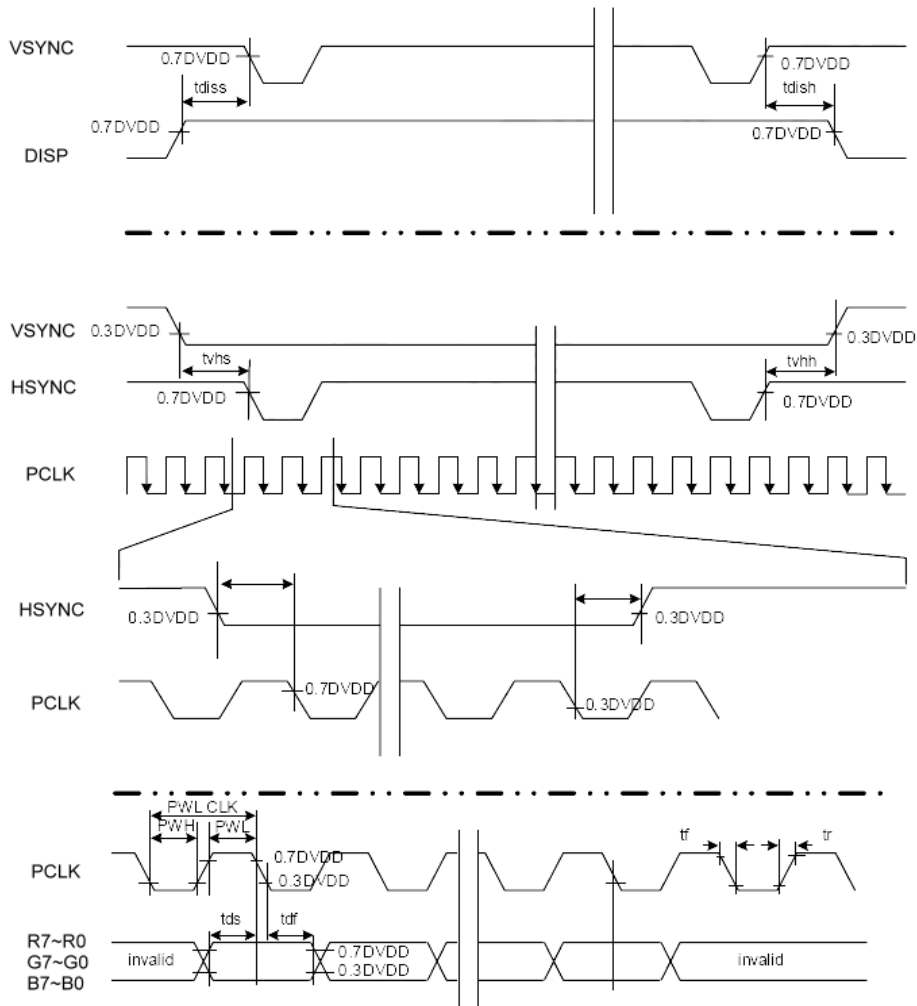

Figure 11.2 Input setup timing



12. Optical Characteristics

The optical characteristics should be measured in a dark environment (≤ 1 lux) or equivalent state with the methods shown in Note (5).

Item		Symbol	Conditions	Min.	Typ.	Max.	Unit	Note
Contrast Ratio		CR	$\theta_x=0^\circ, \theta_Y=0^\circ$ Viewing Normal Angle	300	(450)	-	-	(2),(5)
Response Time		$T_{R+} T_F$		-	20	-	ms	(3)
Luminance(Center)		LC		400	(500)	-	cd/m ²	(4),(5)
Brightness uniformity		B _{UNI}		70	(75)	-	%	(5),(6)
Color Chromaticity	Red	R _x		0.575	0.625	0.675	-	(1),(5)
		R _y		0.294	0.344	0.394	-	
	Green	G _x		0.299	0.349	0.399	-	
		G _y		0.526	0.576	0.626	-	
	Blue	B _x		0.095	0.145	0.195	-	
		B _y		0.052	0.102	0.152	-	
	White	W _x	0.272	0.322	0.372	-		
		W _y	0.293	0.343	0.393	-		
Viewing Angle	Horizontal	θ_{x+}	CR \geq 10	50	(65)	-	deg.	
		θ_{x-}		50	(65)	-		
	Vertical	θ_{Y+}		45	(50)	-		
		θ_{Y-}		55	(60)	-		



Note (1) Definition of Viewing Angle (θ_x , θ_y):

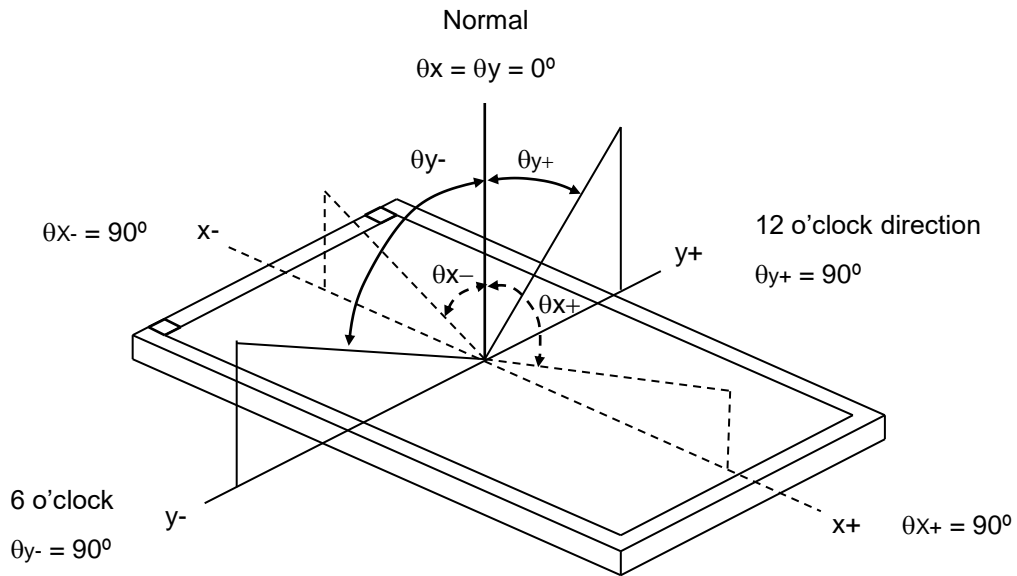

Note (2) Definition of Contrast Ratio (CR):

$$\text{Contrast ratio (CR)} = \frac{\text{Luminance measured when LCD on the "White" state}}{\text{Luminance measured when LCD on the "Black" state}}$$

Note (3) Definition of Response Time (T_R , T_F):

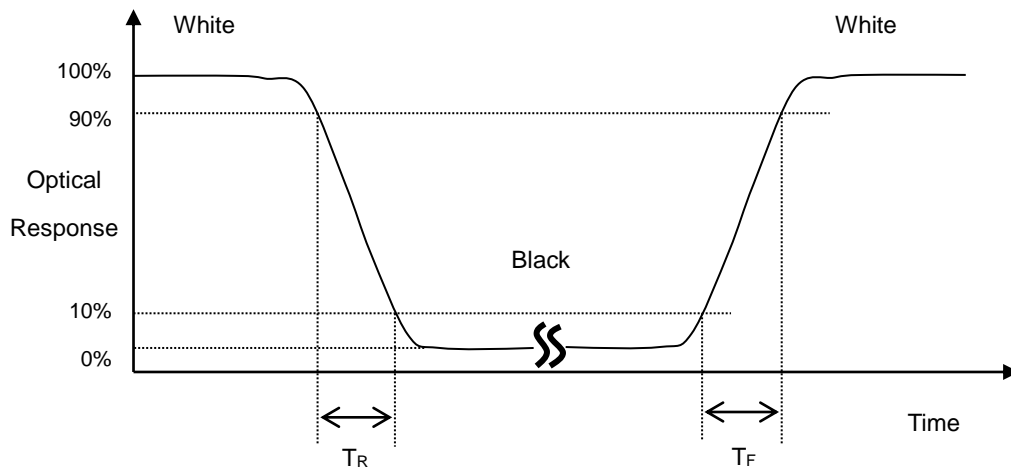



Note (4) Measurement Set-Up:

The LCD module should be stabilized at a given temperature for 30 minutes to avoid abrupt temperature change during measuring. In order to stabilize the luminance, the measurement should be executed after lighting Backlight for 30 minutes in a windless room.

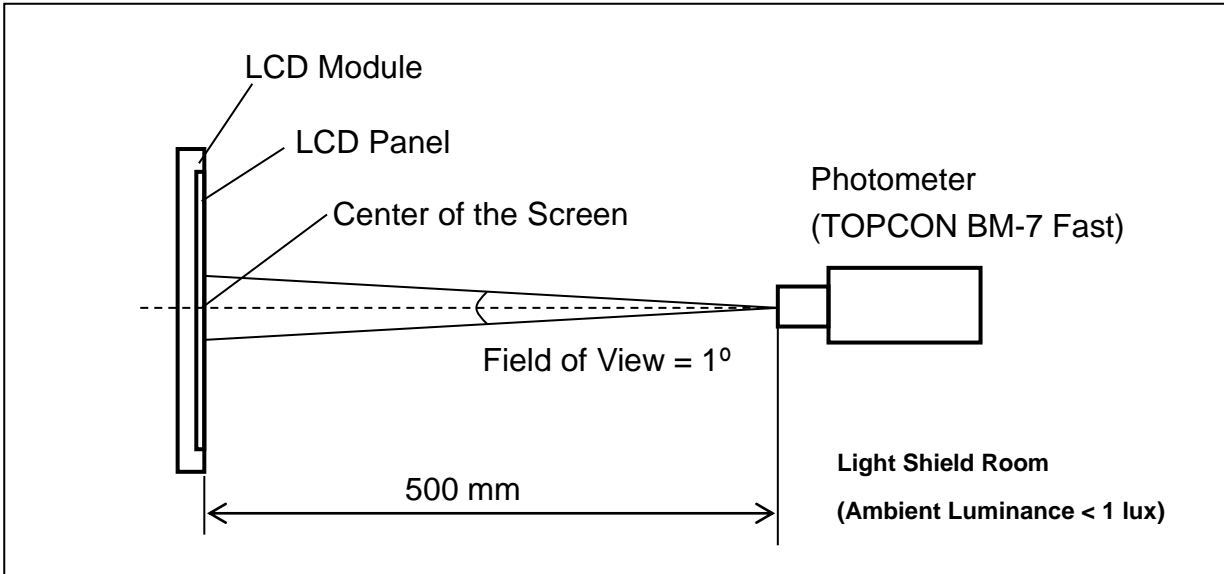

Note (5) Definition of brightness uniformity

Brightness uniformity=(Min Luminance of 9 points)/(Max Luminance of 9 points)×100%

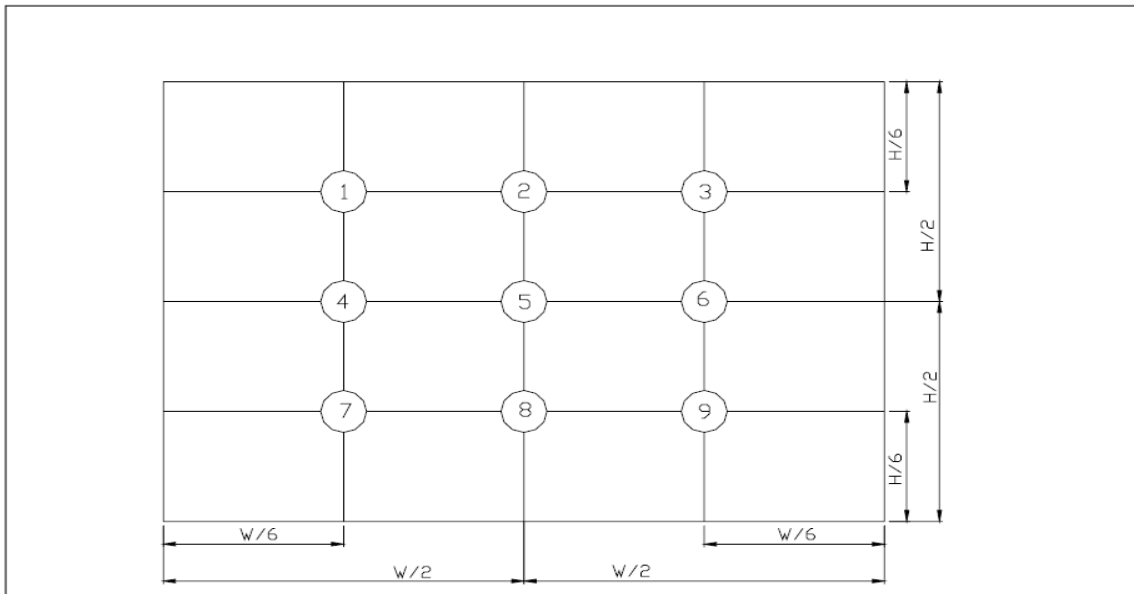

(單位 : mm)

**13. Reliability Test**

No.	Test Items	Test Condition	Remark
1	High Temperature Storage Test	T _a = 80°C 240 hours	-
2	Low Temperature Storage Test	T _a = -30°C 240 hours	-
3	High Temperature Operation Test	T _a = 70°C 240 hours	-
4	Low Temperature Operation Test	T _a = -20°C 240 hours	-
5	High Temperature and High Humidity Operation Test	T _a =60°C 90%RH 240 hours	-
6	Electro Static Discharge Test (non-operating)	-Panel Surface/Top Case : 150pF, 330Ω Air: ±15kV, Contact: ±8kV	-
7	Mechanical Shock Test (non-operating)	Half sine wave, 100G, 6ms 3 times shock of each six surfaces	-
8	Vibration Test (non-operating)	Sine wave, 10 ~ 55 ~ 10Hz, 3 axis, 2 hours/axis	-
9	Thermal Shock Test (non-operating)	-20°C(30min) ~ 70°C(30min),100 cycles	-
10	Drop Test(with Carton) (non-operating)	Height: 80cm 1 corner, 3 edges, 6 surfaces	-



14. Packaging

Packing Method

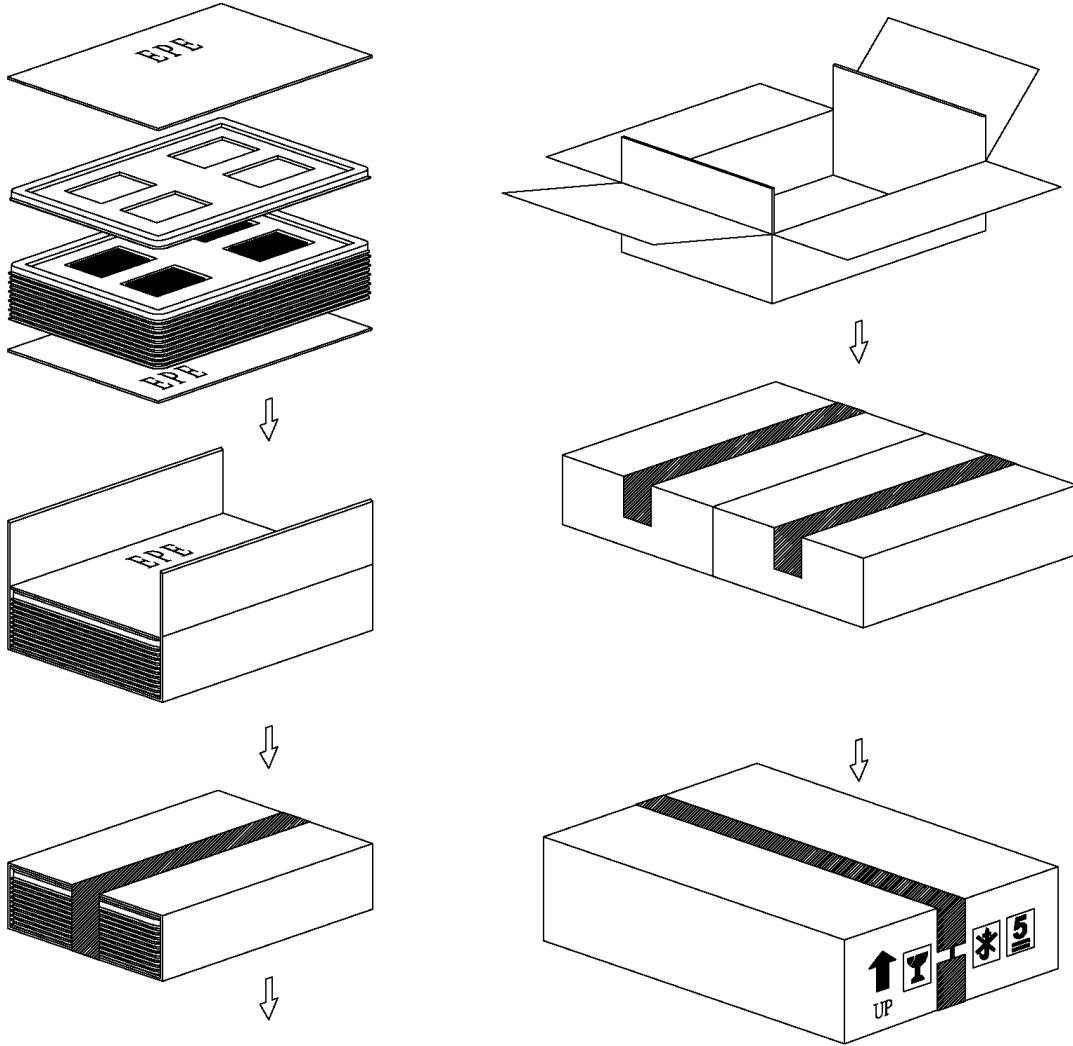

PARTS LIST					
	ITEM	SIZE(LxWxH) unit:mm	MATERIAL	Q.T.Y	NOTE
1	TRAY	372.0x262.0x16.0	PS	28	
2	CARD BOARD(P1)	816.0x375.0x3.5	CARTON	2	
3	CARD BOARD(P2)	945.0x275.0x3.5	CARTON	2	
4	CARD BOARD(P3)	375.0x265.0x3.5	CARTON	4	
5	INTERNAL BOX(B2)	400.0x290.0x150.0	CARTON	2	
6	EXTERNAL BOX(B1)	600.0x420.0x170.0	CARTON	1	
7	PRODUCT	105.5x67.2x3.95		104	



15. Precautions

15.1 Assembly and Handling Precautions

- (1) Do not apply rough force such as bending or twisting to the module during assembly.
- (2) It's recommended to assemble or to install a module into the user's system in clean working areas. The dust and oil may cause electrical short or worsen the polarizer.
- (3) Don't apply pressure or impulse to the module to prevent the damage of LCD panel and Backlight.
- (4) Always follow the correct power-on sequence when the LCD module is turned on. This can prevent the damage and latch-up of the CMOS LSI chips.
- (5) Do not plug in or pull out the I/F connector while the module is in operation.
- (6) Do not disassemble the module.
- (7) Use a soft dry cloth without chemicals for cleaning, because the surface of polarizer is very soft and easily scratched.
- (8) Moisture can easily penetrate into LCD module and may cause the damage during operation.
- (9) High temperature or humidity may deteriorate the performance of LCD module. Please store LCD module in the specified storage conditions.
- (10) When ambient temperature is lower than 10°C, the display quality might be reduced. For example, the response time will become slow.

15.2 Safety Precautions

- (1) If the liquid crystal material leaks from the panel, it should be kept away from the eyes or mouth. In case of contact with hands, skin or clothes, it has to be washed away thoroughly with soap.
- (2) After the module's end of life, it is not harmful in case of normal operation and storage.



P-TEC

MODEL NO.

PT482743A-TLMWD-EM10

SPEC SAMPLE

PAGE

21/29

16.Outline Drawing

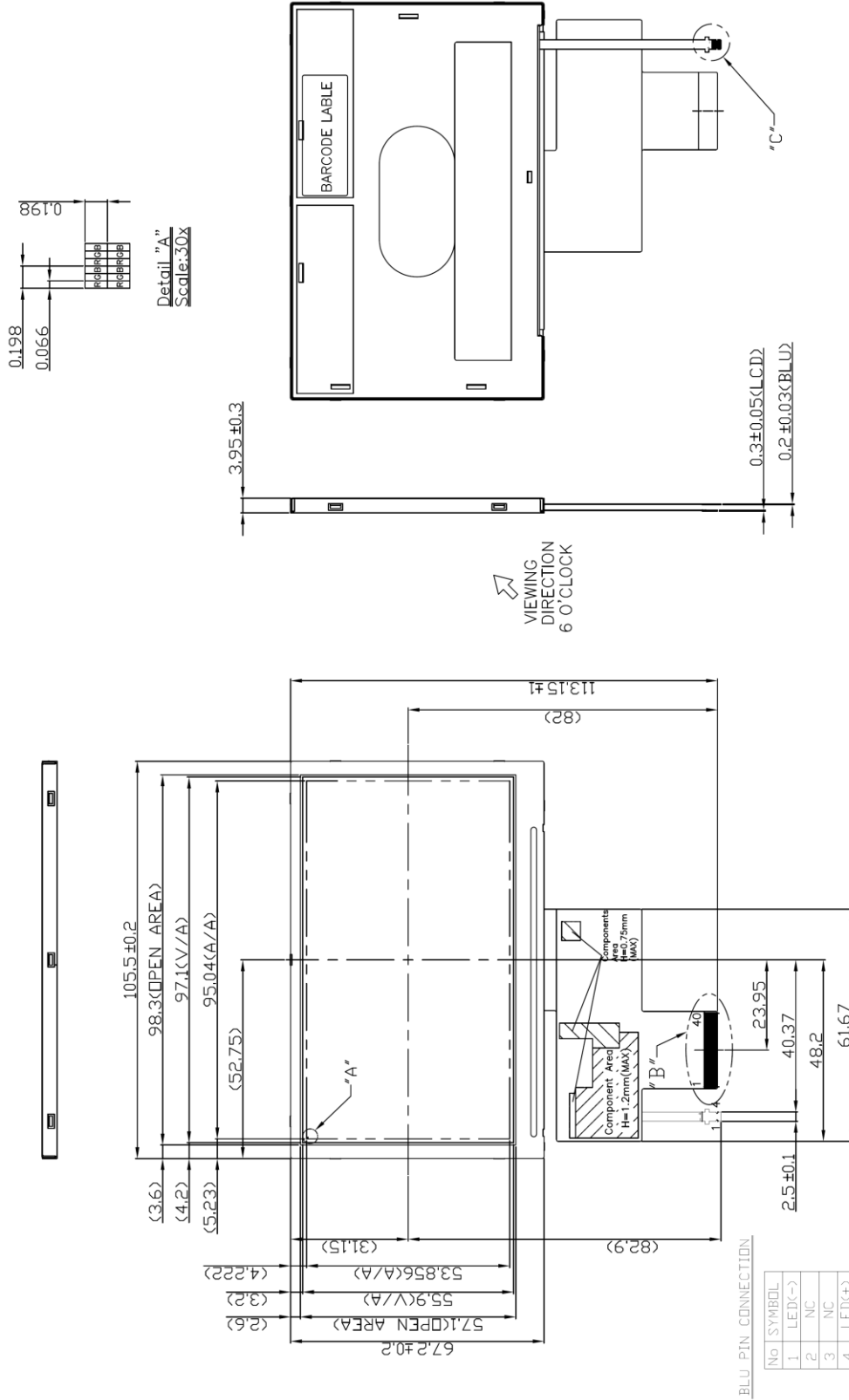



P-TEC

MODEL NO.

PAGE

PT482743A-TLMWD-EM10

SPEC SAMPLE

22/29

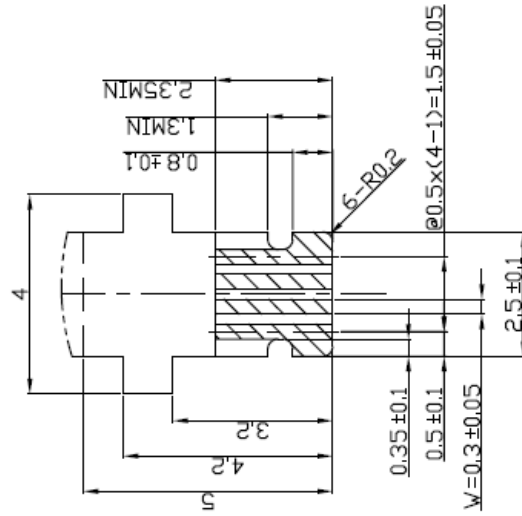

Detail "C"
Scale: 10x

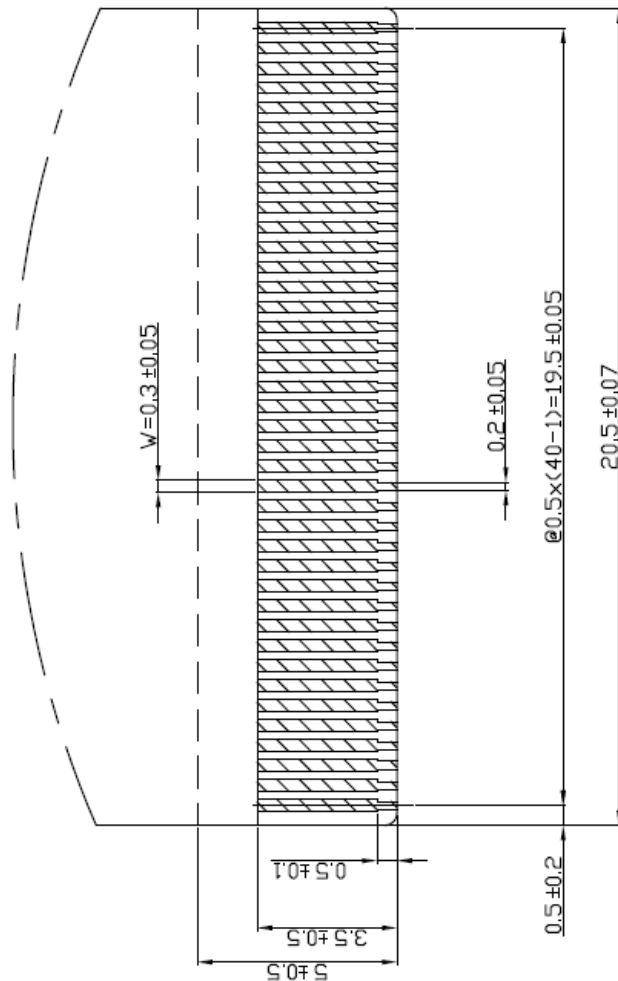

Detail "B"
Scale: 8x

17. Definition of Labels

The bar code nameplate is pasted on each module as illustration, and its definitions are as following explanation.



P-TEC

MODEL NO.

PAGE

PT482743A-TLMWD-EM10

SPEC SAMPLE

23/29

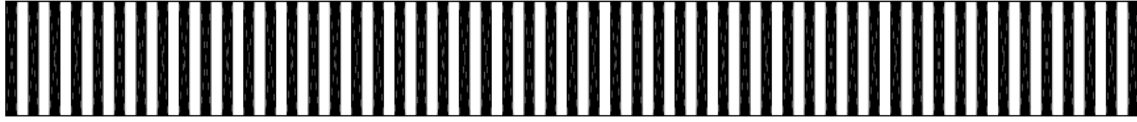

PT482743A-TLMWD-EM10

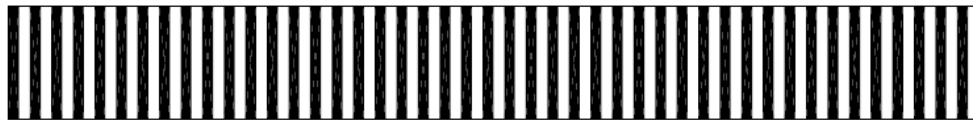

ABCDEFGHIJKLM

(a) Module Name: PT482743A-TLMWD-EM10

(b) Serial ID:

A B C D E F G H I J K L M

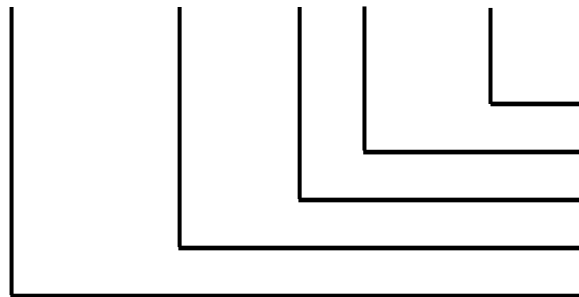

Serial No.
Revision Code
Factory Code
Manufactured Date
Screen Size

Serial ID includes the information as below:

(a) Screen size (Diagonal): Inch Code (ABCD)

3.5" → 0350

10.4" → 1040

(b) Manufactured Date: Year, Month, Day (EFG)

Year (E)

Year	2000	2001	2002	2003	2004	2005	2006	2007	2008	2009
Mark	0	1	2	3	4	5	6	7	8	9

Month (F)

Month	Jan.	Feb.	Mar.	Apr.	May	Jun.	Jul.	Aug.	Sep.	Oct.	Nov.	Dec.
Mark	1	2	3	4	5	6	7	8	9	A	B	C



P-TEC

MODEL NO.

PAGE

PT482743A-TLMWD-EM10

SPEC SAMPLE

24/29

Day (G)

Day	1	2	3	4	5	6	7	8	9	10	11	12	13	14	15	16
Mark	1	2	3	4	5	6	7	8	9	A	B	C	D	E	F	G
Day	17	18	19	20	21	22	23	24	25	26	27	28	29	30	31	
Mark	H	I	J	K	L	M	N	O	P	Q	R	S	T	U	V	

(c) Factory Code (H):

For P-TEC internal use.

(d) Revision Code (I):

Cover all the change, for example: 1: Rev.1, 2: Rev.2, 3: Rev.3...etc.

(e) Serial No. (JKLM):

Manufacturing sequence of product, for example: 0001~9999.



18. Incoming Inspection Standards

18.1 The environmental condition of inspection

The environmental condition and visual inspection shall be conducted as below.

- (1) Ambient temperature $25 \pm 5^{\circ}\text{C}$
- (2) Humidity: $60 \pm 5\% \text{ RH}$
- (3) Viewing distance is approximately 35 ~ 40 cm
- (4) Viewing angle is normal to the LCD panel as Fig _1(10°)
- (5) Ambient Illumination: 300 ~ 500 Lux for external appearance inspection

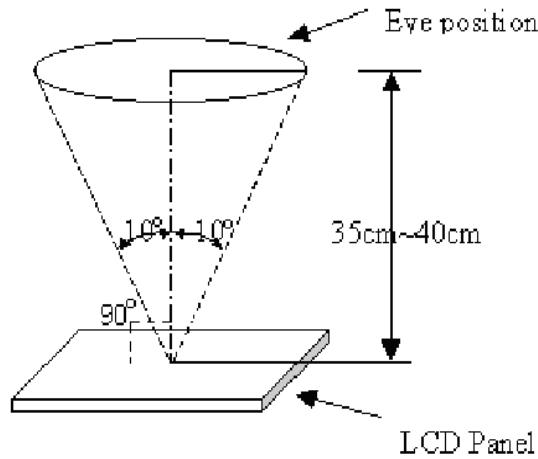

Fig _ 1

18.2 The defects classify of AQL as following:

Class of defects	AQL	Definition
Major	0.65%	It is defect that is likely to result in failure or to reduce materially the usability of the intended function.
Minor	1.5%	It is a defect that will not result in functioning problem with deviation classified.



18.3 Inspection Parameters

Item		Specification/Description			Note	
Display	Function	No Display			-	
		Malfunction			-	
Operating	Contrast ratio	Out of Spec			-	
	Line defect	No obvious Vertical and Horizontal line defect in bright , dark and colored.			-	
	Point Defect (red,green,blue,dark , white)	Item	Acceptable number			Note: 1、4、 5、6
			A	B	Total	
		BRIGHT DOT	$N \leq 2$	$N \leq 2$	$N \leq 7$	
		DARK DOT	$N \leq 3$	$N \leq 4$		
		TOTAL DOT	$N \leq 4$	$N \leq 5$		
TWO ADJACENT DOT	NOT ALLOWED					
THREE OR MORE ADJACENT DOT	NOT ALLOWED					
External Inspection (non-operating)	Scratch on the polarizer	L(mm)	W(mm)	Acceptable number	Note:2	
		$L \leq 2.5$	$W \leq 0.1$	4		
		$L > 2.5$	$W > 0.1$	0		
	Dent or bubble on the polarizer	Dimension(mm)		Acceptable number	Note:3	
		$D \leq 0.5$		4		
		$D \leq 0.15$		Disregard		
	Foreign material on the polarizer	Dimension(mm)		Acceptable number	Note:3	
		$D \leq 0.5$		4		
		$D \leq 0.15$		Disregard		



P-TEC

MODEL NO.

PAGE

PT482743A-TLMWD-EM10

SPEC SAMPLE

27/29

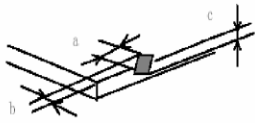
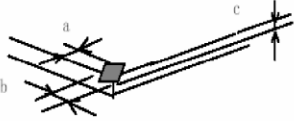
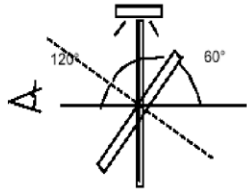
Item		Specification/Description			Note
Touch Panel	Scratch	L(mm)	W(mm)	Acceptable number	Note:2
		$L \leq 10$	$W < 0.05$	Disregard	
			$0.05 \leq W < 0.1$	$N \leq 4$	
			$W \geq 0.1$	0	
	Foreign Materials (Linear shape)	$L \leq 10$	$W < 0.05$	Disregard	Note:2
			$0.05 \leq W < 0.1$	$N \leq 3$	
			$W \geq 0.1$	0	
	Foreign Materials (Circular shape)	Dimension(mm)		Acceptable number	Note:3
		$D \leq 0.25$		Disregard	
		$0.25 < D \leq 0.5$		$N \leq 6$	
$D > 0.5$		0			
Glass chipping			$a \leq 5\text{mm}$ $b \leq 3\text{mm}$ $c \leq t$ (t : Glass think)	Note:7	
			$a \leq 3\text{mm}$ $b \leq 3\text{mm}$ $c \leq t$ (t : Glass think)	Note:7	
Newton-ring	(In case of doubtful situations) Observe on 60° from the product surface under a while Fluorescent lamp(3-wavelength lamp).		Average diameter $\leq 1/3$ Touch Panel area Disregard.	Note:7	
					



Note1. The definition of dot defect : The dot defect was judged after repair and the size of a defective dot over 1/2 of whole dot is regarded as one defective dot.

Note2.

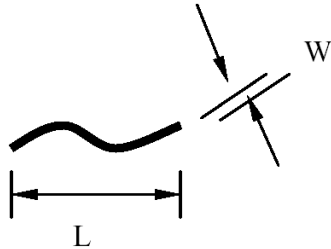

Note3. D : Diameter $D=(a+b)/2$

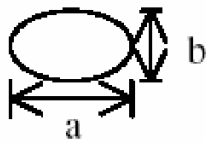

Note4. Bright dot is defined through 6% transmission ND Filter as following.

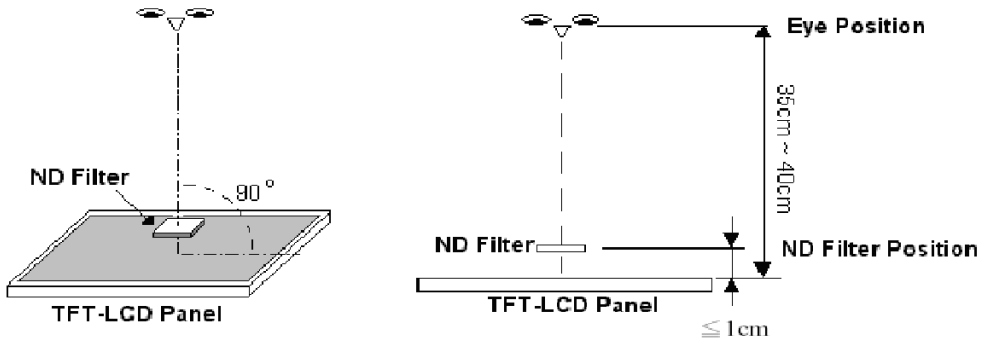

Note5. ADJACENT DOT





Note6.

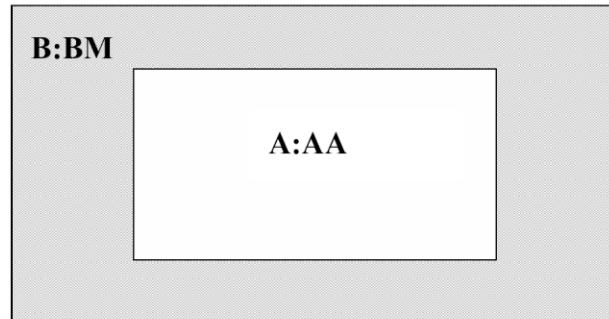

Note7.

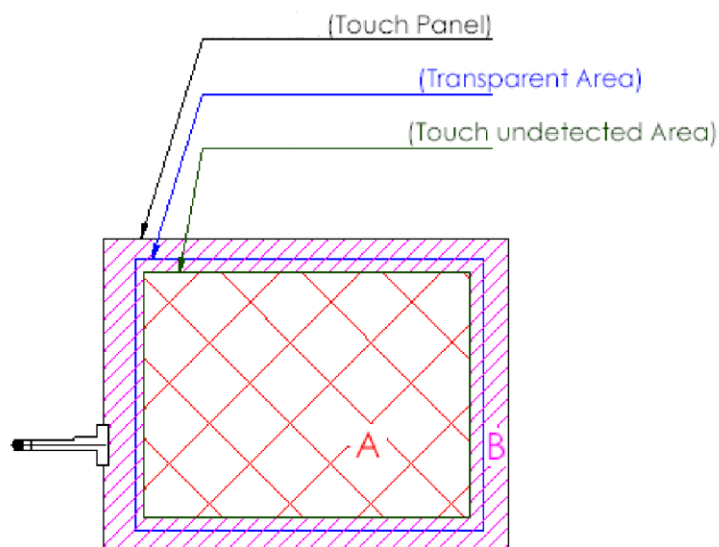

A area : Without any defect point effect on normal operation.

B area : None-specify

4. Handling of LCM

- (1) Don't give external shock.
- (2) Don't apply excessive force on the surface.
- (3) Liquid in LCD is hazardous substance. Must not lick and swallow. when the liquid is attach to your hand, skin, cloth etc. Wash it out thoroughly and immediately.
- (4) Don't operate it above the absolute maximum rating.
- (5) Don't disassemble the LCM.