

**0.36 inch ( 9.14 mm )**

**SINGLE DIGIT NUMERIC LED DISPLAYS**

**UVS-36X SERIES**

**DESCRIPTION**

The UVS-360/367 is 0.36 inch (9.14mm) height single digit display.  
Choices of five colors-high efficiency red/bright red/green/yellow/red orange.  
High efficiency red and bright red displays have red face and red segments.  
Green,yellow and red orange displays have gray face and white segments.  
The bright red and green LED chip are made from GaP on a transparent GaP substrate.  
The yellow and red orange LED chip are made from GaAsP on a transparent GaP substrate.

**FEATURES**

- Industry Standard Size
- Wide Viewing angle
- Continuous uniform segments.
- Excellent characters appearance
- Low power requirement

**DEVICES**

PART NO.	DESCRIPTION	PACKAGE DIMENSION	INTERNAL CIRCUIT DIAGRAM
UVS-360	Common Anode	Fig. 1	Fig. 2
UVS-367	Common Cathode		

**ABSOLUTE MAXIMUM RATINGS**

@ T<sub>A</sub>=25 °C

PARAMETER	HLEFF. RED	BRIGHT RED	GREEN	YELLOW	RED ORANGE	UNIT
Power Dissipation Per Segment	75	40	75	60	75	mW
Peak Forward Current Per Segment ( 1/10 Duty Cycle, .0.1ms pulse width)	100	60	100	80	100	mA
Continuous Forward Current Per Segment	25	15	25	20	25	mA
Derating Linear From 25°C Per Segment	0.33	0.2	0.33	0.27	0.33	mA/°C
Reverse Voltage Per Segment	5	5	5	5	5	V
Operating Temperature Range	-35°Cto+85°C					
Storage Temperature Range	-35°Cto+85°C					
Solder Temperature 1/16 inch Below Seating Plane for 3 Seconds at 260°C						



# 0.36 inch ( 9.14 mm ) SINGLE DIGIT NUMERIC LED DISPLAYS UVS-36X SERIES

## PACKAGE DIMENSIONS

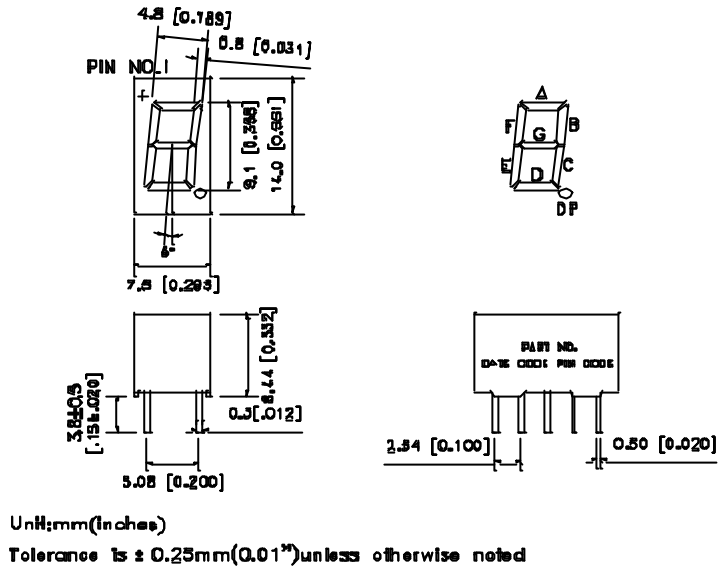

Fig. 1

## INTERNAL CIRCUIT DIAGRAM

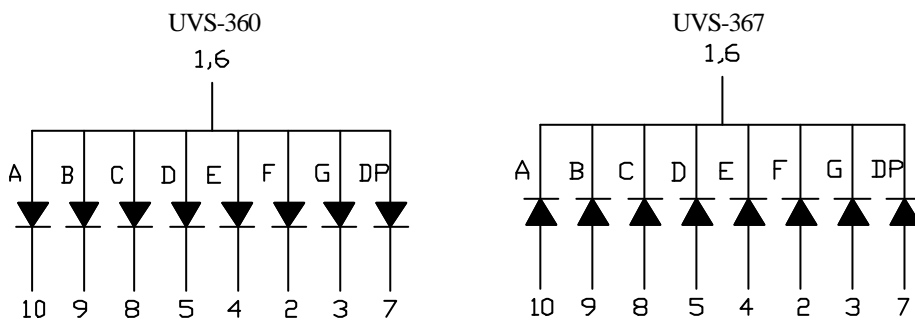

Fig. 2

0.36 inch ( 9.14 mm )

## **SINGLE DIGIT NUMERIC LED DISPLAYS    UVS-36X SERIES**

### **PIN CONNECTION**

PIN	CONNECTION	
	UVS-360	UVS-367
1	COMMON ANODE * 1	COMMON CATHODE * 1
2	CATHODE F	ANODE F
3	CATHODE G	ANODE G
4	CATHODE E	ANODE E
5	CATHODE D	ANODE D
6	COMMON ANODE * 1	COMMON CATHODE * 1
7	CATHODE D . P .	ANODE D . P .
8	CATHODE C	ANODE C
9	CATHODE B	ANODE B
10	CATHODE A	ANODE A

**NOTES: 1. PIN 1 & 6 are internally connected.**

### **ELECTRICAL/OPTICAL CHARACTERISTICS**

#### **HI.EFF. RED(UVS-360HR / 367HR)**

@ T<sub>A</sub>=25°C

PARAMETER	SYMBOL	MIN.	TYP.	MAX.	UNIT	TEST CONDITION
Average Luminous Intensity	I <sub>V</sub>	800	2000		μcd	I <sub>F</sub> = 10 mA
Peak Emission Wavelength	λ <sub>p</sub> /Hue		635/623		nm	I <sub>F</sub> = 20 mA
Spectral Line Half-Width	Δλ		40		nm	I <sub>F</sub> = 20 mA
Forward Voltage, Per Segment	V <sub>F</sub>		2.1	2.6	V	I <sub>F</sub> = 20 mA
Reverse Current, Per Segment	I <sub>R</sub>			100	μA	V <sub>R</sub> = 5 V
Luminous Intensity Matching Ratio	I <sub>v</sub> - m			2:1		I <sub>F</sub> = 10 mA

#### **BRIGHT RED(UVS-360P / 360P)**

@ T<sub>A</sub>=25°C

PARAMETER	SYMBOL	MIN.	TYP.	MAX.	UNIT	TEST CONDITION
Average Luminous Intensity	I <sub>V</sub>	320	750		μcd	I <sub>F</sub> = 10 mA
Peak Emission Wavelength	λ <sub>p</sub> /Hue		697/657		nm	I <sub>F</sub> = 20 mA
Spectral Line Half-Width	Δλ		90		nm	I <sub>F</sub> = 20 mA
Forward Voltage, Per Segment	V <sub>F</sub>		2.1	2.6	V	I <sub>F</sub> = 20 mA
Reverse Current, Per Segment	I <sub>R</sub>			100	μA	V <sub>R</sub> = 5 V
Luminous Intensity Matching Ratio	I <sub>v</sub> - m			2:1		I <sub>F</sub> = 10 mA

**UNI**

Unity Opto Technology Co., Ltd.

11/14/2000

0.36 inch ( 9.14 mm )

**SINGLE DIGIT NUMERIC LED DISPLAYS**

**UVS-36X SERIES**

**ELECTRICAL/OPTICAL CHARACTERISTICS**

**GREEN (UVS-360G / 367G)**

@ T<sub>A</sub>=25 °C

PARAMETER	SYMBOL	MIN.	TYP.	MAX.	UNIT	TEST CONDITION
Average Luminous Intensity	I <sub>V</sub>	800	2000		mcd	I <sub>F</sub> = 10 mA
Peak Emission Wavelength	λ <sub>p</sub> /Hue		565/569		nm	I <sub>F</sub> = 20 mA
Spectral Line Half-Width	Δλ		30		nm	I <sub>F</sub> = 20 mA
Forward Voltage, Per Segment	V <sub>F</sub>		2.1	2.6	V	I <sub>F</sub> = 20 mA
Reverse Current, Per Segment	I <sub>R</sub>			100	mA	V <sub>R</sub> = 5 V
Luminous Intensity Matching Ratio	I <sub>v</sub> - m			2:1		I <sub>F</sub> = 10 mA

**YELLOW(UVS-360Y / 367Y)**

@ T<sub>A</sub>=25 °C

PARAMETER	SYMBOL	MIN.	TYP.	MAX.	UNIT	TEST CONDITION
Average Luminous Intensity	I <sub>V</sub>	800	2000		μcd	I <sub>F</sub> = 10 mA
Peak Emission Wavelength	λ <sub>p</sub> /Hue		585/588		nm	I <sub>F</sub> = 20 mA
Spectral Line Half-Width	Δλ		35		nm	I <sub>F</sub> = 20 mA
Forward Voltage, Per Segment	V <sub>F</sub>		2.1	2.6	V	I <sub>F</sub> = 20 mA
Reverse Current, Per Segment	I <sub>R</sub>			100	μA	V <sub>R</sub> = 5 V
Luminous Intensity Matching Ratio	I <sub>v</sub> - m			2:1		I <sub>F</sub> = 10 mA

**RED ORANGE(UVS-360E / 367E)**

@ T<sub>A</sub>=25 °C

PARAMETER	SYMBOL	MIN.	TYP.	MAX.	UNIT	TEST CONDITION
Average Luminous Intensity	I <sub>V</sub>	800	2000		μcd	I <sub>F</sub> = 10 mA
Peak Emission Wavelength	λ <sub>p</sub> /Hue		630/621		nm	I <sub>F</sub> = 20 mA
Spectral Line Half-Width	Δλ		40		nm	I <sub>F</sub> = 20 mA
Forward Voltage, Per Segment	V <sub>F</sub>		2.0	2.6	V	I <sub>F</sub> = 20 mA
Reverse Current, Per Segment	I <sub>R</sub>			100	μA	V <sub>R</sub> = 5 V
Luminous Intensity Matching Ratio	I <sub>v</sub> - m			2:1		I <sub>F</sub> = 10 mA

**0.36 inch ( 9.14 mm )**

**SINGLE DIGIT NUMERIC LED DISPLAYS UVS-36X SERIES**

**TYPICAL ELECTRICAL/OPTICAL CHARACTERISTIC CURVES**

( Ambient Temperature =25°C Unless Otherwise Noted )

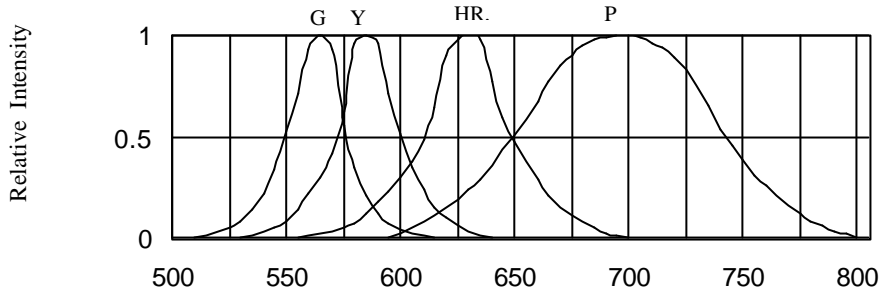

FIG.1 RELATIVE LUMINOUS INTENSITY VS. WAVELENGTH

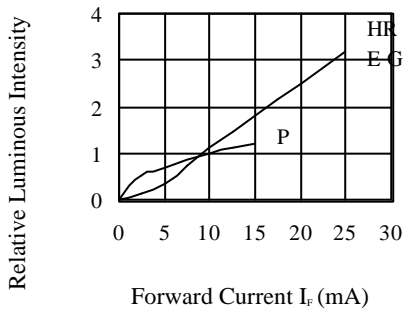

FIG.2 RELATIVE LUMINOUS INTENSITY VS. FORWARD CURRENT

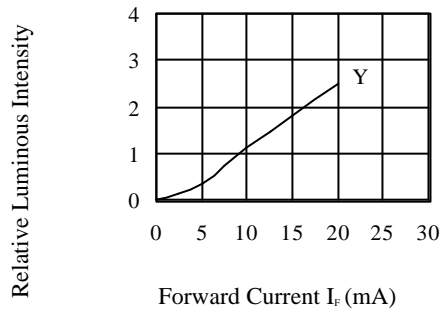

FIG.2-1 RELATIVE LUMINOUS INTENSITY VS. FORWARD CURRENT

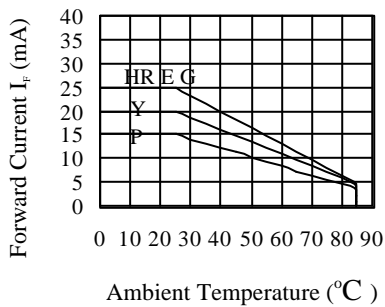

FIG.3 ALLOWABLE DC CURRENT VS. AMBIENT TEMPERATURE

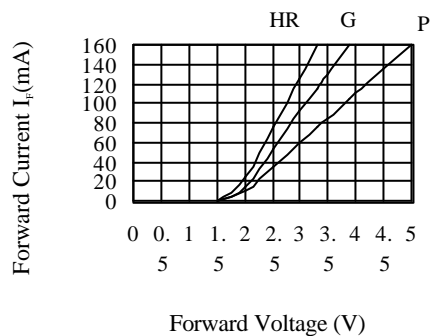

FIG.4 FORWARD CURRENT VS. FORWARD VOLTAGE