

Data sheet | Item number: 753-465

2-channel analog input; 0 ... 20 mA; Single-ended

[www.wago.com/753-465](http://www.wago.com/753-465)

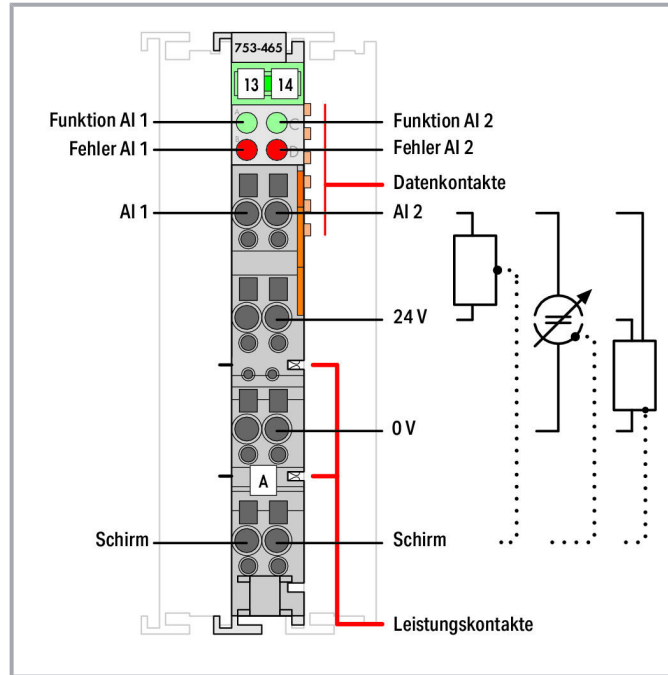
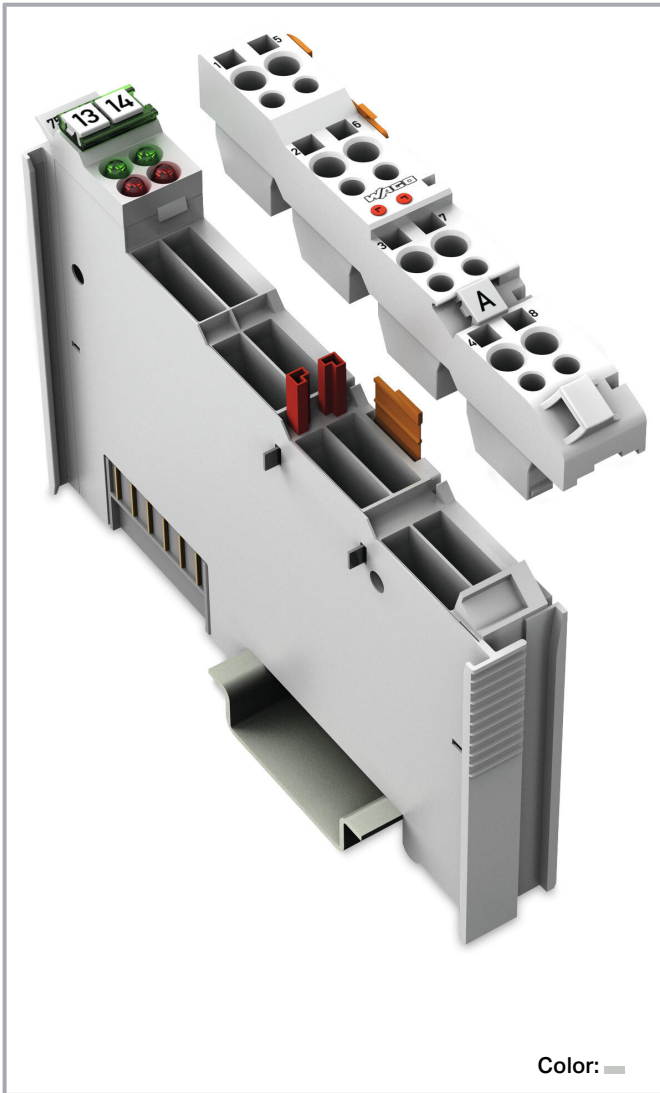

Subject to changes. Please also observe the further product documentation!

WAGO Kontakttechnik GmbH & Co. KG  
Hansastr. 27  
32423 Minden  
Phone: +49571 887-0 | Fax: +49571 887-169  
Email: [info.de@wago.com](mailto:info.de@wago.com) | Web: [www.wago.com](http://www.wago.com)

Do you have any questions about our products?  
We are always happy to take your call at +49 (571) 887-44222.

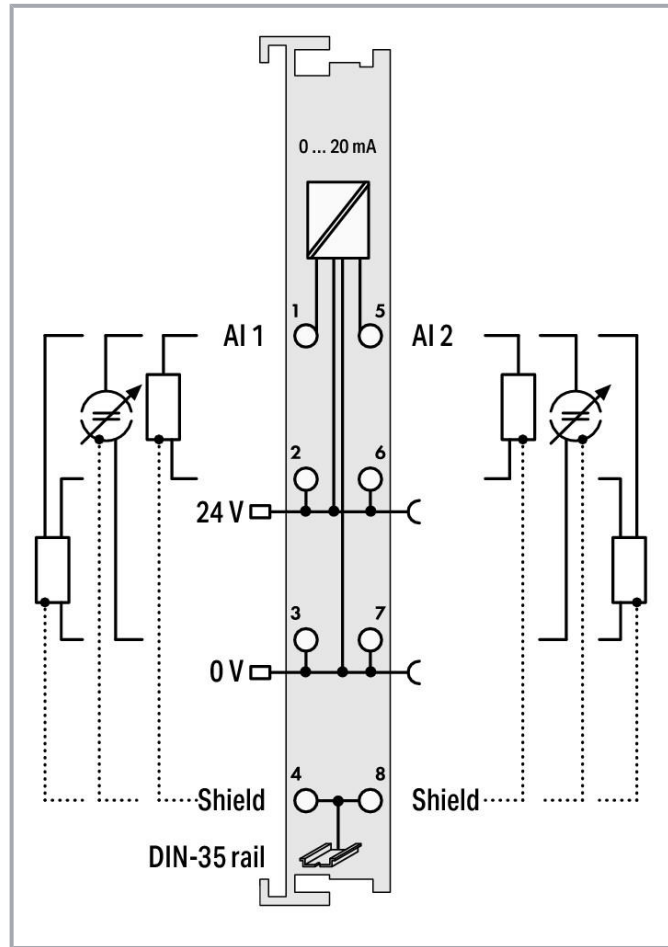
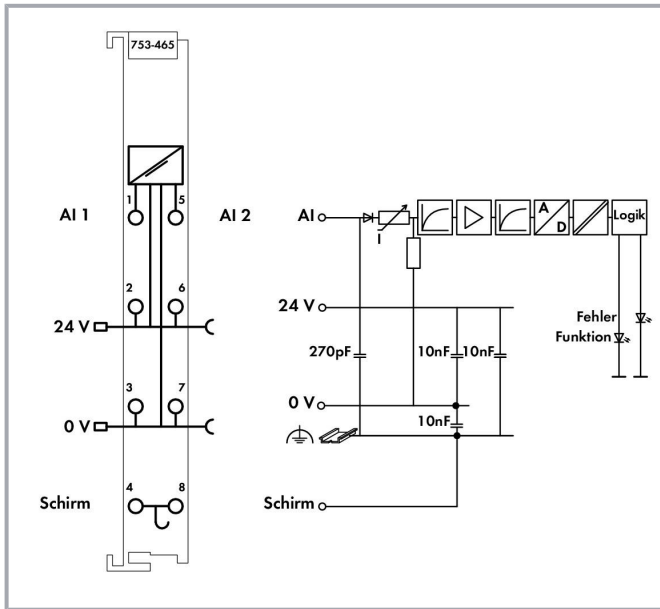

## Item description

This analog input module powers field-side signal conditioners and transmits electrically isolated analog signals to the bus system.

The 24 V field supply is derived from the module's power jumper contacts.

The shield directly connects to the DIN-rail.

This module supplies the voltage for 2-wire signal conditioners that have no power supply of their own.

### Note:

Pluggable connectors and coding fingers (753 Series) are not included.

Subject to changes. Please also observe the further product documentation!



## Data

### Technical data

Number of analog inputs	2
Total number of channels (module)	2
Signal type	Current
Signal type (current)	0 ... 20 mADC
Sensor connection	2 x (2-wire, 3-wire)
Input voltage (max.)	10 V
Signal characteristic	Single-ended
Resolution [bit]	12 bits
Input resistance (max.)	220 Ω
Data width	2 x 16-bit data; 2 x 8-bit control/status (optional)
Conversion time (typ.)	2 ms
Measurement error (reference temperature)	25 °C
Measurement error – deviation (max.) from the upper-range value	0.2 %
Temperature error (max.) of the upper-range value	0.01 %/K
Supply voltage (system)	5 VDC; via data contacts
Power consumption (5 V system supply)	75 mA
Supply voltage (field)	24 VDC (-25 ... +30 %); via power jumper contacts (power supply via blade contact; transmission via spring contact)
Isolation	500 V system/field
Number of incoming power jumper contacts	2
Number of outgoing power jumper contacts	2

### Connection data

Connection technology: inputs/outputs	8 x CAGE CLAMP®
Connection type (1)	Inputs/Outputs
Solid conductor	0.08 ... 2.5 mm <sup>2</sup> / 28 ... 14 AWG
Fine-stranded conductor	0.08 ... 2.5 mm <sup>2</sup> / 28 ... 14 AWG
Strip length	9 ... 10 mm / 0.35 ... 0.39 inch

### Physical data

Width	12 mm / 0.472 inch
Height	100 mm / 3.937 inch
Depth	69.8 mm / 2.748 inch

Subject to changes. Please also observe the further product documentation!

WAGO Kontakttechnik GmbH & Co. KG  
 Hansastr. 27  
 32423 Minden  
 Phone: +49571 887-0 | Fax: +49571 887-169  
 Email: [info.de@wago.com](mailto:info.de@wago.com) | Web: [www.wago.com](http://www.wago.com)

Do you have any questions about our products?  
 We are always happy to take your call at +49 (571) 887-44222.



Depth from upper edge of DIN-rail	62.6 mm / 2.465 inch
-----------------------------------	----------------------

### Mechanical data

Mounting type	DIN-35 rail
Wiring interface	Pluggable

### Material data

Color	light gray
Housing material	Polycarbonate; polyamide 6.6
Fire load	0.773 MJ
Weight	41.5 g
Conformity marking	CE

### Environmental requirements

Surrounding air temperature (operation)	0 ... 55 °C
Surrounding air temperature (storage)	-40 ... 85 °C
Protection type	IP20
Pollution degree (5)	2 per IEC 61131-2
Operating altitude	0 ... 2000 m
Mounting position	horizontal (standing/lying); vertical
Relative humidity (without condensation)	95 %
Vibration resistance	per IEC 60068-2-6
Shock resistance	15g per IEC 60068-2-27
EMC immunity to interference	per EN 61000-6-2
EMC emission of interference	per EN 61000-6-4
Exposure to pollutants	Per IEC 60068-2-42 and IEC 60068-2-43
Permissible H <sub>2</sub> S contaminant concentration at a relative humidity 75 %	10 ppm
Permissible SO <sub>2</sub> contaminant concentration at a relative humidity 75 %	25 ppm

### Commercial data





Product Group	15 (Remote I/O)
PU (SPU)	1 Stück
Packaging type	box
Country of origin	DE

Subject to changes. Please also observe the further product documentation!

GTIN	4045454394462
Customs tariff number	85389099990

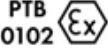
## Approvals / Certificates

### Ex-Approvals

Logo	Approval	Additional Approval Text	Certificate name
	ATEX TUEV Nord Cert GmbH	EN 60079-0	TÜV 07 ATEX 554086 X en.
 Ex nA IIC T4 Gc	CCCEX CQST/CNEX	CNCA-C23-01	2020312310000215
	EAC Brjansker Zertifizierungsstelle	TP TC 012/2011	EAC RU C-DE.AM02. B.00163/19
	TUEV Nord TUEV Nord Cert GmbH	IEC 60079-0	IECEX TUN 09.0001 X
	UL Underwriters Laboratories Inc. (HAZARDOUS LOCATIONS)	UL 121201	E198726 Sec.1

### Country specific Approvals

Logo	Approval	Additional Approval Text	Certificate name
	KC National Radio Research Agency	Article 58-2, Clause 3	MSIP- REM-W43- AIM750

### UL-Approvals

Logo	Approval	Additional Approval Text	Certificate name
	UL UL International Netherlands B.V. (ORDINARY LOCATIONS)	UL 508	E175199 Sec.1

Subject to changes. Please also observe the further product documentation!

## Required accessories

### Pluggable connector

Male connector/plug



**Item no.: 753-110**  
Plug

[www.wago.com/753-110](http://www.wago.com/753-110)

## Optional accessories

### Shield termination

Shield clamping saddle



**Item no.: 790-116**  
Shield clamping saddle; 19 mm wide; diameter of compatible conductor; 7 ... 16 mm

[www.wago.com/790-116](http://www.wago.com/790-116)



**Item no.: 790-124**  
Shield clamping saddle; 27 mm wide; diameter of compatible conductor; 6 ... 24 mm

[www.wago.com/790-124](http://www.wago.com/790-124)



**Item no.: 790-108**  
Shield clamping saddle; 11 mm wide; diameter of compatible conductor; 3 ... 8 mm

[www.wago.com/790-108](http://www.wago.com/790-108)



**Item no.: 790-140**  
Shield clamping saddle; diameter of compatible conductor

[www.wago.com/790-140](http://www.wago.com/790-140)



**Item no.: 790-216**  
Shield clamping saddle; 21.8 mm wide; 6 ... 16 mm

[www.wago.com/790-216](http://www.wago.com/790-216)



**Item no.: 790-220**  
Shield clamping saddle; 30 mm wide; 6 ... 20 mm

[www.wago.com/790-220](http://www.wago.com/790-220)



**Item no.: 790-208**  
Shield clamping saddle; 12.4 mm wide; 3 ... 8 mm

[www.wago.com/790-208](http://www.wago.com/790-208)

### Marking accessories

Marker carrier

**Item no.: 750-103**  
Group marker carrier

[www.wago.com/750-103](http://www.wago.com/750-103)

Marker

**Item no.: 2009-145/000-006**  
Mini-WSB Inline; for Smart Printer; 1700 pieces on roll; stretchable 5 - 5.2 mm; plain; snap-on type; blue /000-006

[www.wago.com/2009-145](http://www.wago.com/2009-145)











**Item no.: 2009-145**  
Mini-WSB Inline; for Smart Printer; 1700 pieces on roll; stretchable 5 - 5.2 mm; plain; snap-on type; white

[www.wago.com/2009-145](http://www.wago.com/2009-145)

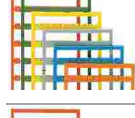
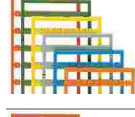
**Item no.: 2009-145/000-002**  
Mini-WSB Inline; for Smart Printer; 1700 pieces on roll; stretchable 5 - 5.2 mm; plain; snap-on type; yellow /000-002

[www.wago.com/2009-145](http://www.wago.com/2009-145)

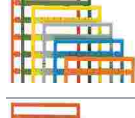
Subject to changes. Please also observe the further product documentation!

	<b>Item no.: 2009-145/000-007</b> Mini-WSB Inline; for Smart Printer; 1700 pieces on roll; stretchable 5 - 5.2 mm; plain; snap-on type; gray	<a href="http://www.wago.com/2009-145/000-007">www.wago.com/2009-145/000-007</a>
	<b>Item no.: 2009-145/000-005</b> Mini-WSB Inline; for Smart Printer; 1700 pieces on roll; stretchable 5 - 5.2 mm; plain; snap-on type; red	<a href="http://www.wago.com/2009-145/000-005">www.wago.com/2009-145/000-005</a>
	<b>Item no.: 2009-145/000-012</b> Mini-WSB Inline; for Smart Printer; 1700 pieces on roll; stretchable 5 - 5.2 mm; plain; snap-on type; orange	<a href="http://www.wago.com/2009-145/000-012">www.wago.com/2009-145/000-012</a>
	<b>Item no.: 2009-145/000-023</b> Mini-WSB Inline; for Smart Printer; 1700 pieces on roll; stretchable 5 - 5.2 mm; plain; snap-on type; green	<a href="http://www.wago.com/2009-145/000-023">www.wago.com/2009-145/000-023</a>
	<b>Item no.: 2009-145/000-024</b> Mini-WSB Inline; for Smart Printer; 1700 pieces on roll; stretchable 5 - 5.2 mm; plain; snap-on type; violet	<a href="http://www.wago.com/2009-145/000-024">www.wago.com/2009-145/000-024</a>
	<b>Item no.: 248-501/000-006</b> Mini-WSB marking card; as card; not stretchable; plain; snap-on type; blue	<a href="http://www.wago.com/248-501/000-006">www.wago.com/248-501/000-006</a>
	<b>Item no.: 248-501/000-007</b> Mini-WSB marking card; as card; not stretchable; plain; snap-on type; gray	<a href="http://www.wago.com/248-501/000-007">www.wago.com/248-501/000-007</a>
	<b>Item no.: 248-501/000-002</b> Mini-WSB marking card; as card; not stretchable; plain; snap-on type; yellow	<a href="http://www.wago.com/248-501/000-002">www.wago.com/248-501/000-002</a>
	<b>Item no.: 248-501/000-012</b> Mini-WSB marking card; as card; not stretchable; plain; snap-on type; orange	<a href="http://www.wago.com/248-501/000-012">www.wago.com/248-501/000-012</a>
	<b>Item no.: 248-501</b> Mini-WSB marking card; as card; not stretchable; plain; snap-on type; white	<a href="http://www.wago.com/248-501">www.wago.com/248-501</a>
	<b>Item no.: 248-501/000-017</b> Mini-WSB marking card; as card; not stretchable; plain; snap-on type; light green	<a href="http://www.wago.com/248-501/000-017">www.wago.com/248-501/000-017</a>
	<b>Item no.: 248-501/000-005</b> Mini-WSB marking card; as card; not stretchable; plain; snap-on type; red	<a href="http://www.wago.com/248-501/000-005">www.wago.com/248-501/000-005</a>

Subject to changes. Please also observe the further product documentation!



**Item no.: 248-501/000-024**  
Mini-WSB marking card; as card; not stretchable; plain; snap-on type; violet

[www.wago.com/248-501/000-024](http://www.wago.com/248-501/000-024)



**Item no.: 248-501/000-023**  
Mini-WSB marking card; as card; not stretchable; plain; snap-on type; green

[www.wago.com/248-501/000-023](http://www.wago.com/248-501/000-023)



**Item no.: 750-100**  
Marker card; as a DIN A4 sheet; plain

[www.wago.com/750-100](http://www.wago.com/750-100)

Group marker carrier



**Item no.: 750-106**  
Group marker carrier

[www.wago.com/750-106](http://www.wago.com/750-106)

Carrier rail

Mounting accessories



**Item no.: 210-197**  
Steel carrier rail; 35 x 15 mm; 1.5 mm thick; 2 m long; slotted; similar to EN 60715; silver-colored

[www.wago.com/210-197](http://www.wago.com/210-197)



**Item no.: 210-198**  
Copper carrier rail; 35 x 15 mm; 2.3 mm thick; 2 m long; unslotted; according to EN 60715; copper-colored

[www.wago.com/210-198](http://www.wago.com/210-198)



**Item no.: 210-504**  
Steel carrier rail; 35 x 7.5 mm; 1 mm thick; 2 m long; slotted; galvanized; according to EN 60715; silver-colored

[www.wago.com/210-504](http://www.wago.com/210-504)

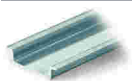

**Item no.: 210-505**  
Steel carrier rail; 35 x 7.5 mm; 1 mm thick; 2 m long; unslotted; galvanized; according to EN 60715; silver-colored

[www.wago.com/210-505](http://www.wago.com/210-505)



**Item no.: 210-506**  
Steel carrier rail; 35 x 15 mm; 1.5 mm thick; 2 m long; unslotted; galvanized; similar to EN 60715; silver-colored

[www.wago.com/210-506](http://www.wago.com/210-506)



**Item no.: 210-508**  
Steel carrier rail; 35 x 15 mm; 1.5 mm thick; 2 m long; slotted; galvanized; similar to EN 60715; silver-colored

[www.wago.com/210-508](http://www.wago.com/210-508)



**Item no.: 210-113**  
Steel carrier rail; 35 x 7.5 mm; 1 mm thick; 2 m long; unslotted; according to EN 60715; silver-colored

[www.wago.com/210-113](http://www.wago.com/210-113)



**Item no.: 210-118**  
Steel carrier rail; 35 x 15 mm; 2.3 mm thick; 2 m long; unslotted; according to EN 60715; silver-colored

[www.wago.com/210-118](http://www.wago.com/210-118)



**Item no.: 210-112**  
Steel carrier rail; 35 x 7.5 mm; 1 mm thick; 2 m long; slotted; according to EN 60715; "Hole width 25 mm; silver-colored

[www.wago.com/210-112](http://www.wago.com/210-112)

Subject to changes. Please also observe the further product documentation!



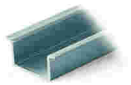

**Item no.: 210-114**

Steel carrier rail; 35 x 15 mm; 1.5 mm thick; 2 m long; unslotted; similar to EN 60715; silver-colored

[www.wago.com/210-114](http://www.wago.com/210-114)



**Item no.: 210-115**

Steel carrier rail; 35 x 7.5 mm; 1 mm thick; 2 m long; slotted; according to EN 60715; "Hole width 18 mm; silver-colored

[www.wago.com/210-115](http://www.wago.com/210-115)

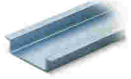

**Item no.: 210-196**

Aluminum carrier rail; 35 x 8.2 mm; 1.6 mm thick; 2 m long; unslotted; similar to EN 60715; silver-colored

[www.wago.com/210-196](http://www.wago.com/210-196)

**Supply module**

Supply module



**Item no.: 750-601**

Power Supply; 24 VDC; fuse holder

[www.wago.com/750-601](http://www.wago.com/750-601)



**Item no.: 750-610**

Power Supply; 24 VDC; fuse holder; Diagnostics

[www.wago.com/750-610](http://www.wago.com/750-610)



**Item no.: 750-602**

Power Supply; 24 VDC

[www.wago.com/750-602](http://www.wago.com/750-602)



**Item no.: 750-612**

Power Supply; 0 ... 230 V AC/DC

[www.wago.com/750-612](http://www.wago.com/750-612)



**Item no.: 753-612**

Power Supply; 0 ... 230 V AC/DC

[www.wago.com/753-612](http://www.wago.com/753-612)



**Item no.: 753-602**

Power Supply; 24 VDC

[www.wago.com/753-602](http://www.wago.com/753-602)

**Pluggable connector**

Coding



**Item no.: 753-150**

753 Series coding elements

[www.wago.com/753-150](http://www.wago.com/753-150)

**System housing**

System enclosure



**Item no.: 850-814/002-000**

IP65 enclosure; Sheet steel (RAL 7035); WxHxD (200x120x200 mm); without flange plate

[www.wago.com/850-814/002-000](http://www.wago.com/850-814/002-000)



**Item no.: 850-815/002-000**

IP65 enclosure; Sheet steel (RAL 7035); WxHxD (300x120x200 mm); without flange plate

[www.wago.com/850-815/002-000](http://www.wago.com/850-815/002-000)



**Item no.: 850-816/002-000**

IP65 enclosure; Sheet steel (RAL 7035); WxHxD (400x120x200 mm); without flange plate

[www.wago.com/850-816/002-000](http://www.wago.com/850-816/002-000)



Subject to changes. Please also observe the further product documentation!

WAGO Kontakttechnik GmbH & Co. KG

Hansastr. 27

32423 Minden

Phone: +49571 887-0 | Fax: +49571 887-169

Email: [info.de@wago.com](mailto:info.de@wago.com) | Web: [www.wago.com](http://www.wago.com)

Do you have any questions about our products?

We are always happy to take your call at +49 (571) 887-44222.

**Item no.: 850-817/002-000**

IP65 enclosure; Sheet steel (RAL 7035); WxHxD (600x120x200 mm); without flange plate

[www.wago.com/850-817/002-000](http://www.wago.com/850-817/002-000)



**Item no.: 850-825**

IP65 enclosure; Aluminium (RAL 7032); WxHxD (160x100x160 mm); 9 x M12, 4 x M20

[www.wago.com/850-825](http://www.wago.com/850-825)



**Item no.: 850-826**

IP65 enclosure; Aluminium (RAL 7032); WxHxD (240x100x160 mm); 4 x M20, 4 x M16, 14 x M12 cable grip

[www.wago.com/850-826](http://www.wago.com/850-826)



**Item no.: 850-827**

IP65 enclosure; Aluminium (RAL 7032); WxHxD (320x100x160 mm); 4 x M20, 8 x M16, 17 x M12 cable grip

[www.wago.com/850-827](http://www.wago.com/850-827)



**Item no.: 850-827/002-000**

IP65 enclosure; Aluminium (RAL 7035); WxHxD (320x100x160 mm); 4 x M20, 8 x M16, 17 x M12 cable grip

[www.wago.com/850-827/002-000](http://www.wago.com/850-827/002-000)



**Item no.: 850-826/002-000**

IP65 enclosure; Aluminium (RAL 7035); WxHxD (240x100x160 mm); 4 x M20, 4 x M16, 14 x M12 cable grip

[www.wago.com/850-826/002-000](http://www.wago.com/850-826/002-000)



**Item no.: 850-828/002-000**

IP65 enclosure; Aluminium (RAL 7035); WxHxD (480x100x160 mm); 4 x M20, 10 x M16, 35 x M12 cable grip

[www.wago.com/850-828/002-000](http://www.wago.com/850-828/002-000)



**Item no.: 850-828**

IP65 enclosure; Aluminium (RAL 7032); WxHxD (480x100x160 mm); 4 x M20, 10 x M16, 35 x M12 cable grip

[www.wago.com/850-828](http://www.wago.com/850-828)



**Item no.: 850-834**

IP65 enclosure; Polyester (RAL 7032); WxHxD (164x100x164 mm); 9 x M12, 4 x M20

[www.wago.com/850-834](http://www.wago.com/850-834)



**Item no.: 850-835**

IP65 enclosure; Polyester (RAL 7032); WxHxD (244x100x164 mm); 4 x M20, 4 x M16, 14 x M12 cable grip

[www.wago.com/850-835](http://www.wago.com/850-835)



**Item no.: 850-836**

IP65 enclosure; Polyester (RAL 7032); WxHxD (324x100x164 mm); 4 x M20, 8 x M16, 17 x M12 cable grip

[www.wago.com/850-836](http://www.wago.com/850-836)

**Downloads**

**Documentation**

**Manual**

2-channel, 0-20mA, single-ended	V 1.2.0	pdf 4.0 MB	Download
System Manual WAGO I/O System 750 / 753 Decentralized Automation Technology	V 3.0.2 2021. 4. 27.	pdf 6.6 MB	Download

Subject to changes. Please also observe the further product documentation!

WAGO Kontakttechnik GmbH & Co. KG  
Hansastr. 27  
32423 Minden  
Phone: +49571 887-0 | Fax: +49571 887-169  
Email: [info.de@wago.com](mailto:info.de@wago.com) | Web: [www.wago.com](http://www.wago.com)

Do you have any questions about our products?  
We are always happy to take your call at +49 (571) 887-44222.



	URL	Download
System Manual Series 750/753 Online HTML		

**Bid Text**

753-465 X81 - Datei	2019. 2. 19.	xml 4.8 kB	Download
753-465 doc - Datei	2017. 10. 17.	doc 28.7 kB	Download

**System Description**

750/753 Series I/O-System – General Product Information		pdf 1.7 MB	Download
Overview on WAGO-I/O-SYSTEM 750 approvals		pdf 780.2 kB	Download

**Additional Information**

Disposal; Electrical and electronic equipment, Packaging	V 1.0.0	pdf 265.8 kB	Download
--	---------	-----------------	----------

**CAD/CAE-Data**

**CAE data**

EPLAN Data Portal 753-465		URL	Download
WSCAD Universe 753-465		URL	Download
ZUKEN Portal 753-465		URL	Download

**CAD data**

2D/3D Models 753-465		URL	Download
----------------------	--	-----	----------

**Environmental Product Compliance**

**Compliance Search**

Environmental Product Compliance 753-465 2-channel analog input; 0 ... 20 mA; Single-ended Subject to changes. Please also observe the further product documentation!		URL	Download
---	--	-----	----------



---

## Installation Notes

## Product family

**750/753 Series I/O System**

[Show all products from the family](#)

Subject to changes. Please also observe the further product documentation!

---

WAGO Kontakttechnik GmbH & Co. KG  
Hansastr. 27  
32423 Minden  
Phone: +49571 887-0 | Fax: +49571 887-169  
Email: [info.de@wago.com](mailto:info.de@wago.com) | Web: [www.wago.com](http://www.wago.com)

Do you have any questions about our products?  
We are always happy to take your call at +49 (571) 887-44222.