

Inductor Selection for Switching Regulators

Introduction/Basic Operation

In switching regulator applications the inductor is used as an energy storage device. When the semiconductor switch is on the current in the inductor ramps up and energy is stored. When the switch turns off energy is released into the load. The amount of energy stored is calculated by the formula **Energy = $\frac{1}{2}LI^2$** (Joules), where:

- L is the inductance in Henrys
- I is the peak value of inductor current

The amount by which the current changes during a switching cycle is known as the ripple current. Ripple current is defined as **$\Delta I = L \cdot di/dt$** :

- V_L is the voltage across the inductor
- di is the ripple current
- dt is the duration for which the voltage is applied

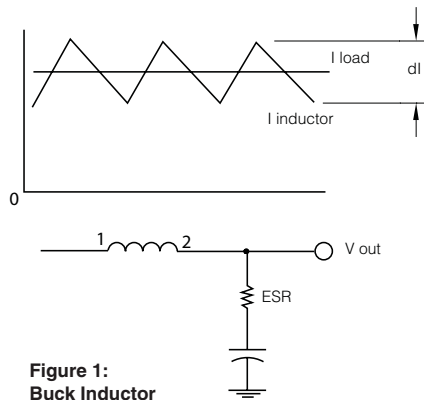
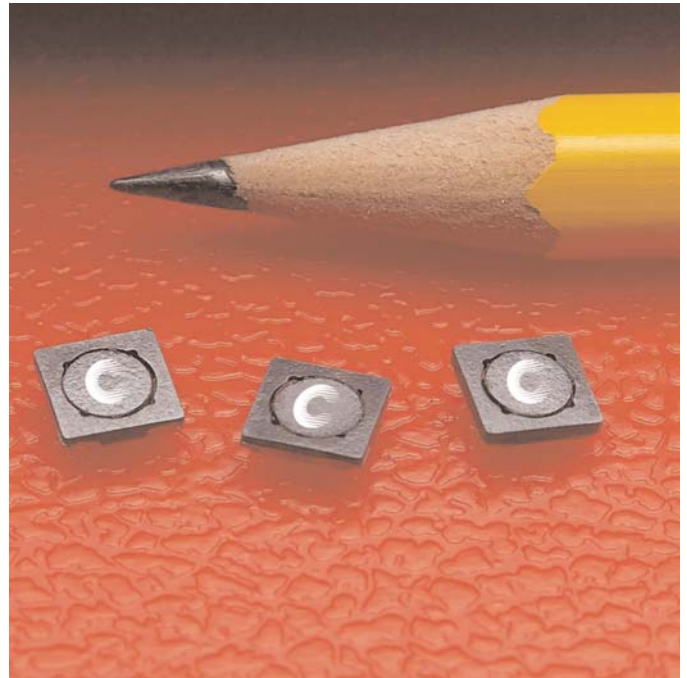

Figure 1:
Buck Inductor

Inductor current is made up of AC and DC components (Figure 1). The AC component is high frequency and will flow through the output capacitor because it has a low HF impedance. A ripple voltage is produced due to the capacitor 'equivalent series resistance' (ESR) that will appear at the output of the switching regulator. This ripple voltage needs to be sufficiently low as not to effect the operation of the circuit the regulator is supplying, normally in the order of 10-50mV_{pk-pk}.

Selecting the correct ripple current impacts the size of the inductor and output capacitor. The capacitor needs to have a sufficiently high ripple current rating or it will overheat and dry out. To achieve a good compromise between inductor and capacitor size a ripple current value of 10-30% of maximum inductor current should be chosen. The current in the inductor will be continuous for output currents greater than 5-15% of full load.



The following parameters need to be defined or calculated to select an inductor:

- Maximum input voltage
- Output voltage
- Switching frequency
- Maximum ripple current
- Duty cycle



SD3814

Inductor Selection: Buck Converters

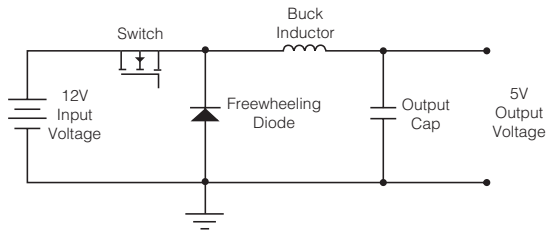

Figure 2:
Buck Inductor Example

Figure 2 Application Parameters:

- Switching frequency= 250kHz
- Input voltage range= $12V \pm 10\%$
- Max ripple current = 220mA
- Output Voltage= 5.0V

Step 1. Calculate the Duty Cycle

- V_0 = output voltage
- V_i = Max input voltage
- $D = V_0 / V_i$
- $D = 5/13.2 = 0.379$

Step 2. Calculate the Voltage Across the Inductance

- $V_1 = V_i - V_0$ (Switch on)
- $V_1 = 13.2 - 5 = 8.2V$
- $V_1 = -V_0$ (Switch off)
- $V_1 = -5V$

Step 3. Calculate the Required Inductance

- $L = V_1 \cdot dt/di$
- $L = (8.2 \times 0.379 / 250 \times 10^3) / 0.22$
- $L = 56\mu H$

Inductor Selection: Boost Converters

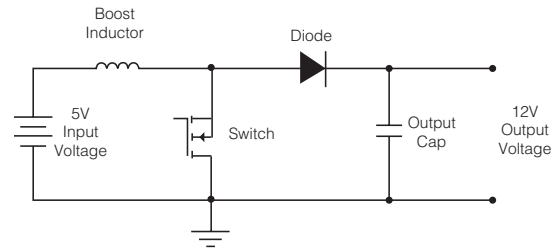

Figure 3:
Boost Inductor Example

Figure 3 Application Parameters:

- Switching frequency= 100kHz
- Input voltage range= 4.5-5.5V
- Max ripple current = 100mA
- Output Voltage= 12.0V

Step 1. Calculate the Duty Cycle:

- V_0 = output voltage
- V_i = Max input voltage
- $D = 1 - (V_i / V_0)$
- $D = 1 - (5.5/12.0) = 0.542$

Step 2. Calculating the voltage across the inductance

- $V_1 = V_i$ (Switch on)
- $V_1 = 5.5V$
- $V_1 = V_0 - V_i$ (Switch off)
- $V_1 = 12 - 5.5 = 6.5V$

Step 3. Calculating the required inductance

- $L = V_1 \cdot dt/di$
- $L = (5.5 \times 0.542 / 100 \times 10^3) / 0.1$
- $L = 298\mu H$

Typical Applications Using Inductors for Switching Regulators

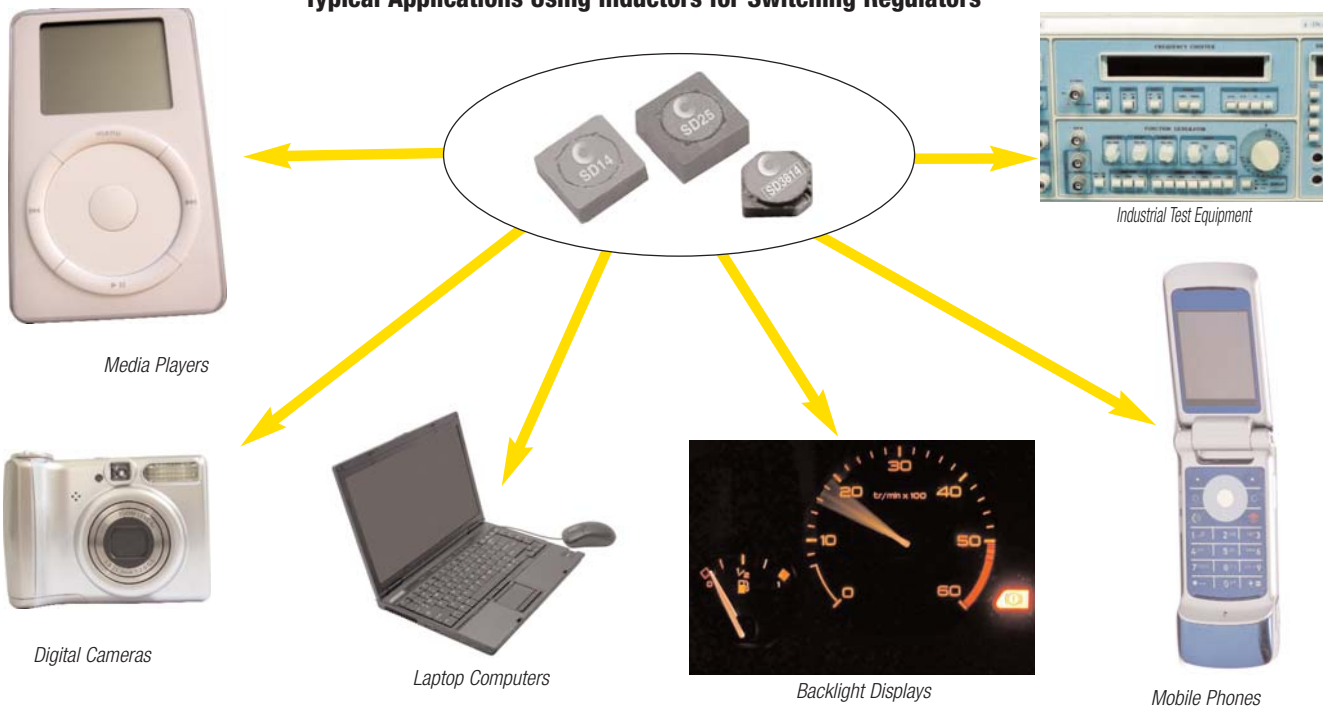

SDH3812							
Part Number	Rated Inductance (μH)	OCL $\mu\text{H} \pm 20\%$	Part Marking Designator	I_{rms} Amps	I_{sat} Amps	DCR $\Omega @ 20^\circ\text{C}$ (Typical)	DCR $\Omega @ 20^\circ\text{C}$ (Maximum)
SDH3812-1R0-R	1.0	0.89	B	2.07	3.00	0.045	0.054
SDH3812-1R5-R	1.5	1.49	D	1.67	2.30	0.069	0.083
SDH3812-2R2-R	2.2	2.23	E	1.37	1.90	0.104	0.124
SDH3812-3R3-R	3.3	3.17	F	1.14	1.60	0.148	0.177
SDH3812-4R7-R	4.7	4.96	G	0.94	1.25	0.220	0.264
SDH3812-100-R	10.0	9.67	J	0.69	0.88	0.398	0.478
SDH3812-220-R	22.0	22.00	L	0.50	0.61	0.750	0.900
SDH3812-330-R	33.0	32.90	M	0.41	0.49	1.132	1.358
SDH3812-470-R	47.0	46.20	N	0.34	0.41	1.583	1.900
SDH3812-101-R	100.0	97.50	Q	0.25	0.28	3.042	3.650
SDH3812-221-R	220.0	218.50	S	0.16	0.19	7.017	8.420



Note: For full product information and a listing of all available inductor values, see <http://www.cooperbussmann.com/datasheets/elx>, Data Sheet number SDH3812 Series.

SDH3812 Dimensions - mm

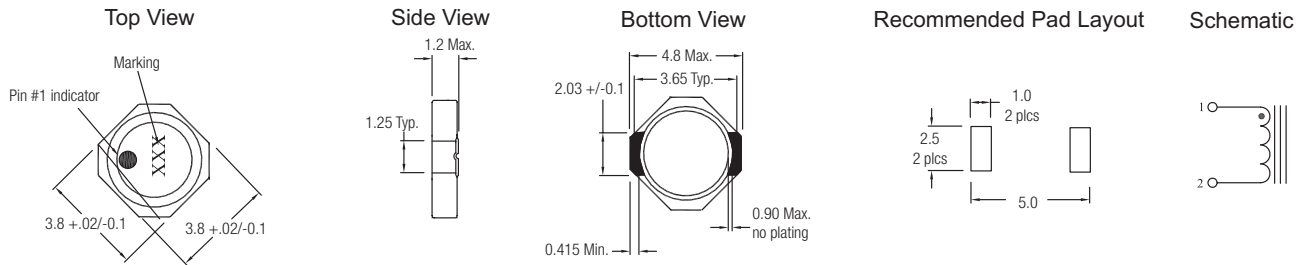

SD3814						
Part Number	Rated Inductance (μH)	OCL $\mu\text{H} \pm 15\%$	Part Marking Designator	I_{rms} Amps	I_{sat} Amps	DCR Ω Typical
SD3814-1R2-R	1.2	1.001	C	1.85	2.67	0.046
SD3814-1R5-R	1.5	1.286	D	1.76	2.35	0.051
SD3814-2R2-R	2.2	1.962	E	1.43	1.90	0.077
SD3814-3R3-R	3.3	2.781	F	1.31	1.60	0.093
SD3814-4R7-R	4.7	4.276	G	1.06	1.29	0.141
SD3814-100-R	10.0	9.830	J	0.713	0.851	0.311
SD3814-220-R	22.0	21.186	L	0.519	0.580	0.589
SD3814-330-R	33.0	32.151	M	0.418	0.471	0.908
SD3814-470-R	47.0	47.210	N	0.346	0.388	1.322



Note: For full product information and a listing of all available inductor values, see <http://www.cooperbussmann.com/datasheets/elx>, Data Sheet number SD38 Series.

SD3814 Dimensions - mm

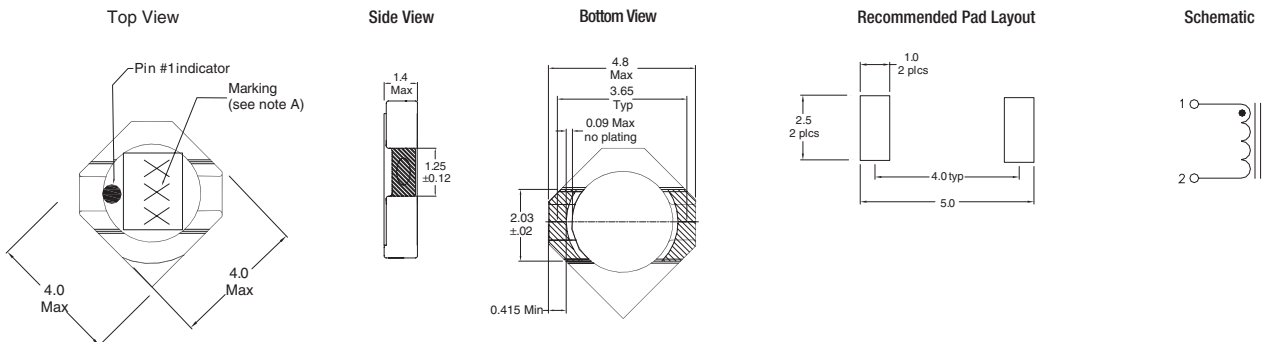

SD14 & SD25						
Part Number	Rated Inductance (μH)	OCL $\pm 20\%$ (μH)	Part Marking	I_{rms} Amps	I_{sat} Amps	DCR Ω Typical
SD14-1R2-R	1.2	1.23	C	2.7	3.35	0.0344
SD14-1R5-R	1.5	1.63	D	2.53	2.91	0.0390
SD14-3R2-R	3.2	3.19	G	1.94	2.08	0.0663
SD14-6R9-R	6.9	6.98	J	1.35	1.41	0.1363
SD14-100-R	10	9.93	L	1.1	1.18	0.2058
SD14-220-R	22	21.93	N	0.806	0.793	0.3853
SD14-330-R	33	32.55	O	0.654	0.651	0.5852
SD14-470-R	47	47.57	P	0.525	0.538	0.9055
SD14-101-R	100	99.25	S	0.386	0.373	1.68
SD14-221-R	220	222	U	0.258	0.249	3.77
SD14-331-R	330	335.1	V	0.206	0.203	5.92
SD14-471-R	470	471.4	W	0.173	0.171	8.34
SD14-102-R	1000	1008	Z	0.126	0.117	15.8
SD25-1R2-R	1.20	1.15	C	3.33	3.81	0.0240
SD25-1R5-R	1.50	1.61	D	3.12	3.23	0.0274
SD25-2R2-R	2.20	2.14	E	2.93	2.80	0.0311
SD25-3R3-R	3.30	3.43	F	2.64	2.21	0.0384
SD25-4R7-R	4.70	5.03	G	2.39	1.83	0.0467
SD25-100-R	10.0	10.35	K	1.80	1.27	0.0824
SD25-220-R	22.0	22.81	M	1.34	0.857	0.1478
SD25-330-R	33.0	33.07	N	1.11	0.711	0.2149
SD25-470-R	47.0	47.89	O	0.919	0.592	0.3156
SD25-101-R	100	100.79	R	0.670	0.398	0.5937
SD25-151-R	150	148.4	S	0.553	0.328	0.8723
SD25-221-R	220	222.4	T	0.446	0.268	1.34
SD25-331-R	330	332.2	U	0.359	0.219	2.07
SD25-471-R	470	472.4	V	0.293	0.184	3.10

Note: SD10, 12, 18 and 20 not shown. For full product information and a listing of all available inductor values, see <http://www.cooperbussmann.com/datasheets/elx>, Data sheet number SD Series

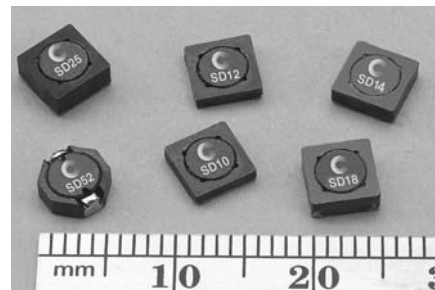

SD Inductor Series

Typical SD Series Applications

- Mobile phones
- Digital cameras
- Industrial test equipment
- Computers
- Uninterruptible power supplies
- Televisions

Typical SD Series Uses

- Buck and boost converters
- LED Drivers
- EL panel drivers
- Backlighting
- Noise filtering chokes

SD14 & SD25 Dimensions - mm

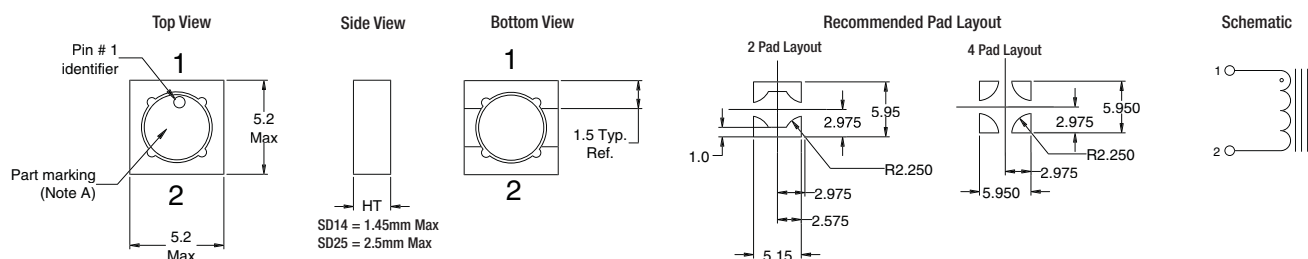

The Cooper Bussmann Coiltronics® brand of magnetics specializes in standard and custom solutions, offering the latest in state-of-the-art low-profile high power density magnetic components. We remain at the forefront of innovation and new technology to deliver the optimal mix of packaging, high efficiency and unbeatable reliability. Our designs utilize high frequency, low core loss materials, and new and custom core shapes in combination with innovative construction and packaging to provide designers with the highest performance parts available on the market. The Coiltronics Brand product line of power magnetics continually expands to satisfy shifts in technology and related market needs. Standard Product Categories include:

- Shielded Drum Inductors
- Toroidal Inductors
- Unshielded Drum Inductors
- Specialty Magnetics
- High Current Inductors
- Custom Magnetics

Please visit <http://www.cooperbussmann.com/datasheets/elx> to see data sheets on the wide variety of inductor solutions we have to offer.

For technical inquiries e-mail InductorTech@cooperindustries.com.

Order samples online - www.cooperbussmann.com

© 2008 Cooper Bussmann
St. Louis, MO 63178
636-394-2877
www.cooperbussmann.com

