

Features

- Digital dual complementary sink/source outputs
- Reverse Voltage Polarity protection for full supply range.
- High output current capability
- Low profile packages: SIP-4L
- Lead Free Package: SIP-4L
- Lead Free Finish/RoHS Compliant (Note 1)

General Description

The AH342 is a bipolar latching hall IC with a pair of complementary push/pull outputs. A dual hall element is used to offset stress induced noise and drift. The robust outputs are capable of sourcing up to 7.4mA and sinking up to 4.4mA. The device contains inherent reverse polarity protection up to the full power supply range.

Applications

- Conveyors
- Motor control
- Power sensing
- Linear or rotary motion detection
- RPM sensing

Ordering Information

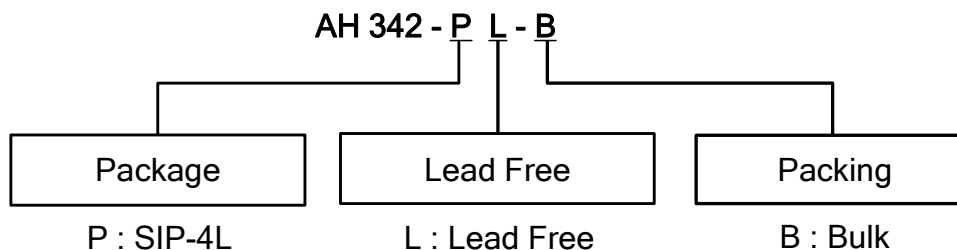

Device	Package Code	Packaging (Note 2)	Bulk	
			Quantity	Part Number Suffix
AH342-PL-B	P	SIP-4L	1000	-B



- Notes:
1. EU Directive 2002/95/EC (RoHS). All applicable RoHS exemptions applied. Please visit our website at http://www.diodes.com/products/lead_free.html.
 2. Pad layout as shown on Diodes Inc. suggested pad layout document AP02001, which can be found on our website at <http://www.diodes.com/datasheets/ap02001.pdf>.

Pin Assignments

(Top View)

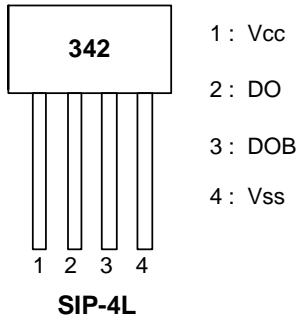

Pin Descriptions

Pin Name	Description
V _{CC}	Positive Power Supply
DO	Output pin
DOB	Output pin
V _{SS}	Ground
NC	No Connect

Block Diagram

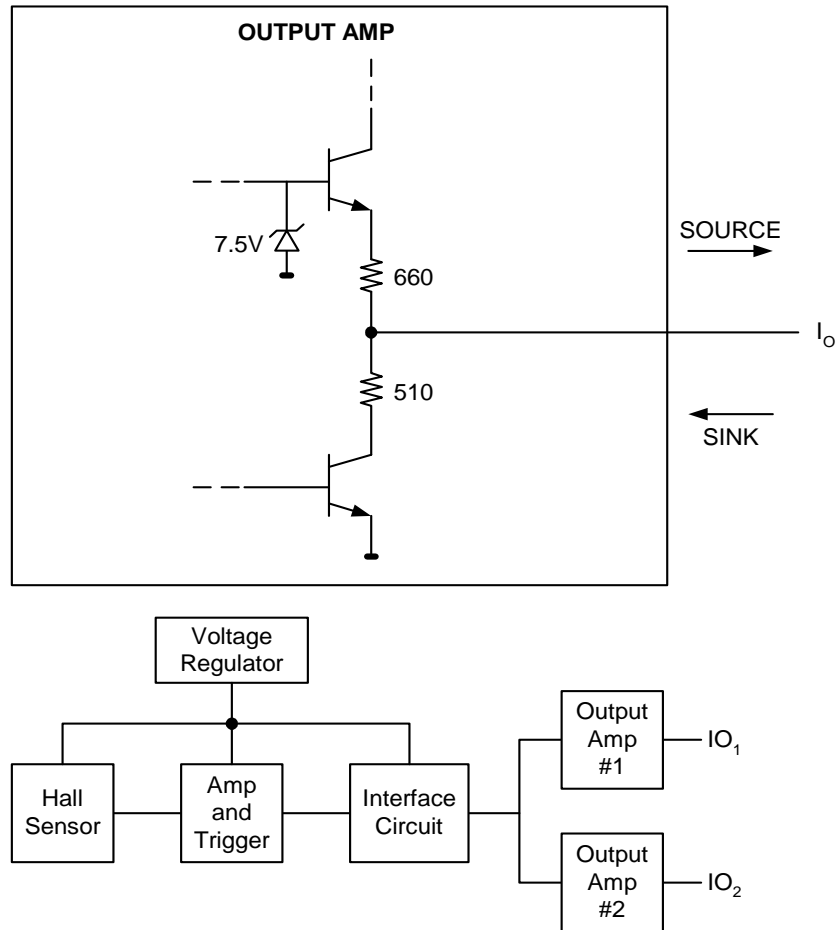

Absolute Maximum Ratings (Note 3)

Symbol	Characteristics	Conditions	Rating	Unit
V_{CC}	Supply voltage	-40°C to 125°C	±28	V
V_{OUT}	Voltage Externally Applied to Output	-40°C to 125°C	-1.2 to 5	V
I_c	Output Current		±10	mA
B	Magnetic Flux density	No limit; the circuit cannot be damaged by magnetic overdrive	Unlimited	
T_{ST}	Storage Temperature	No power applied	-40 to 150	°C

Notes: 3. Absolute maximum ratings are the extreme limits that the device will withstand without damage to the device. However, the electrical and magnetic characteristics are not guaranteed as the maximum limits (above recommended operating conditions) are approached nor will the device necessarily operate at absolute maximum rating.

Recommended Operating Conditions

Symbol	Characteristic	Conditions	Min	Max	Unit
V _{CC}	Supply Voltage	Operating	4.5	28	V
T _A	Operating Ambient Temperature (Note 4)	Operating	-40	125	°C

Notes: 4. Shall not exceed P_D and Safety Operation Area.

Electrical Characteristics (Note 5, 6)

Symbol	Characteristic	Conditions	24°C ± 2°C			-40°C to 125°C			Units
			Min	Typ.	Max	Min	Typ.	Max	
I _{CC}	Supply Current	28V±0.5% supply	4	4.5	6	3	4.5	7	mA
Output Voltage									
V _{OUT}	#1 Sourcing	Switch magnetically operated: No load 28V±0.5% supply. Switch magnetically released: No load 28V±0.5% supply.	6.0	7.0	7.5	-	-	-	V
	#2 Sinking		0	0.1	0.2	-	-	-	
	#1 Sinking		0	0.1	0.2	-	-	-	
	#2 Sourcing		6.0	7.0	7.5	-	-	-	
I _{Leak(sink)}	Leakage (sink)	Apply voltage 0.2V greater than measured output source voltage measure current, no load 28V±0.5% supply.	-	-	1.0	-	-	1.0	µA
Output Current									
I _{OUT}	#1 Sourcing	Apply 2V to output and measure current. Switch magnetically operated, no load 28V±0.5%. Apply 2V to output and measure current. Switch magnetically released, no load 28V±0.5%.	5.5	7.4	8.0	5.0	7.4	8.5	mA
	#2 Sinking		2.8	3.4	4.7	2.4	3.4	5.0	
	#1 Sinking		2.8	3.4	4.7	2.4	3.4	5.0	
	#2 Sourcing		5.5	7.4	8.0	5.0	7.4	8.5	
Output Switching Time									
t _f	Fall Time	90% to 10%; no load 28V±0.5% Supply	-	-	-	-	-	1.0	µs
t _r	Rise Time	10% to 90%; no load 28V±0.5% Supply	-	-	-	-	-	1.0	

Magnetic Characteristics ($T_A = +25^\circ\text{C}$) (Note 5, 6)

(1mT = 10 Gauss)

Symbol	Characteristic	24°C ± 2°C Vs=12Vdc ± 0.5%Vdc		-40°C to 125°C Vs=4.5Vdc to 28Vdc		Unit
		Min	Max	Min	Max	
Bop	Operate Point	40	120	30	150	Gauss
Brp	Release Point	-120	-40	-150	-30	Gauss
Bhy	Hysteresis	120	200	120	200	Gauss

Notes: 5. All the parameters are tested under the 25°C only. The operation temperature (-40°C to 125°C) is guaranteed by design, it is typical value.
6. The magnetic field strength (gauss) required to cause the switch to change state (operate and release) will be as specified in the magnetic characteristics. To test the switch against the specified magnetic characteristics the switch must be placed in a uniform magnetic field.

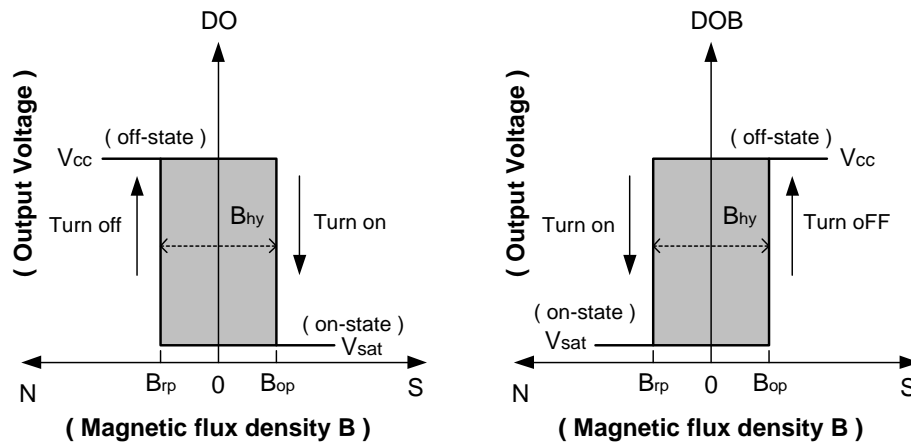

Performance Characteristics

T_A (°C)	25	50	60	70	80	85	90	95	100
P_D (mW)	550	440	396	352	308	286	264	242	220
T_A (°C)	105	110	115	120	125	130	135	140	150
P_D (mW)	198	176	154	132	110	88	66	44	0

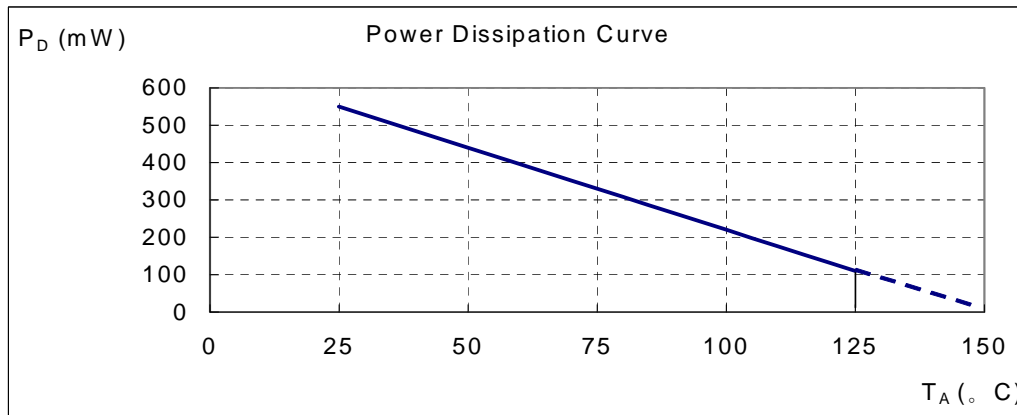

Operating Characteristics

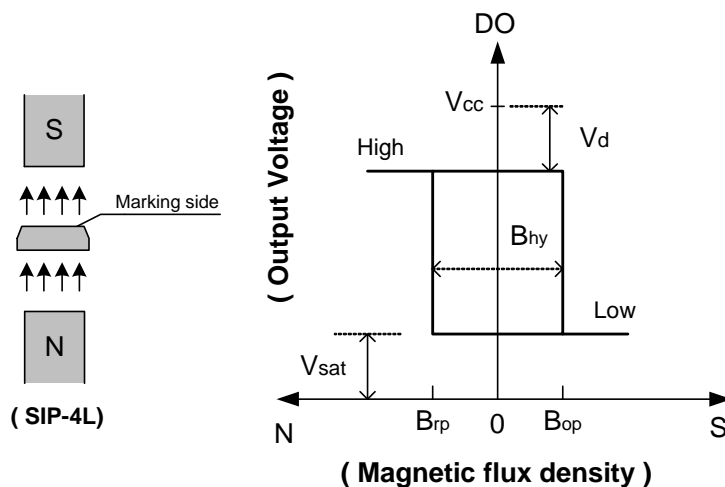

Marking Information

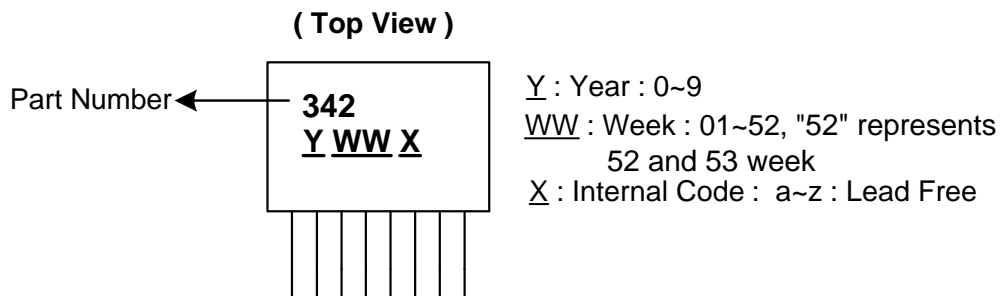

Package Information (All Dimensions in mm)

(1) Package type: SIP-4L

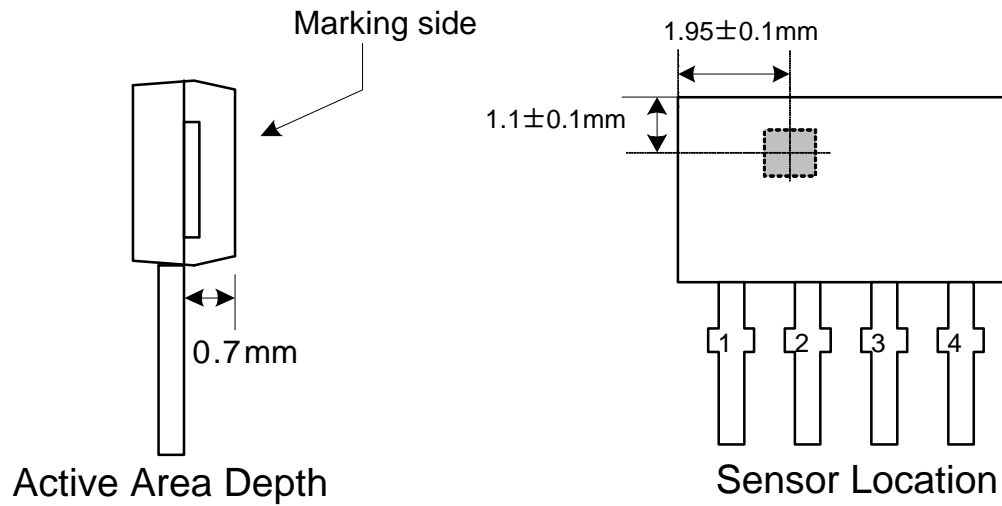

Package Dimension

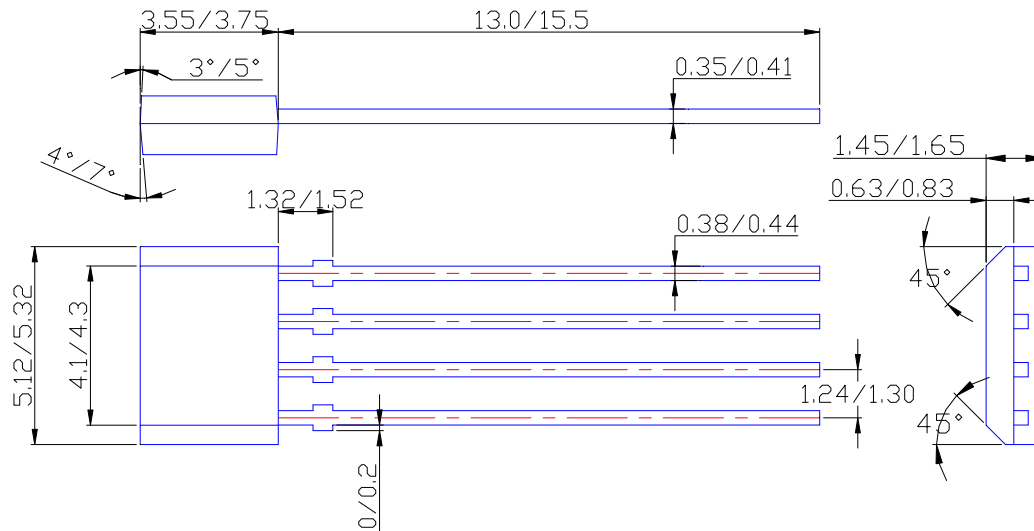

IMPORTANT NOTICE

Diodes Incorporated and its subsidiaries reserve the right to make modifications, enhancements, improvements, corrections or other changes without further notice to any product herein. Diodes Incorporated does not assume any liability arising out of the application or use of any product described herein; neither does it convey any license under its patent rights, nor the rights of others. The user of products in such applications shall assume all risks of such use and will agree to hold Diodes Incorporated and all the companies whose products are represented on our website, harmless against all damages.

LIFE SUPPORT

Diodes Incorporated products are not authorized for use as critical components in life support devices or systems without the expressed written approval of the President of Diodes Incorporated.