

Solid-state Relay

G3CN

PCB-mounting SSR for FA Equipment Requiring High Reliability

- Wide I/O voltage range: 3 to 28 VDC input and 75 to 264 VAC output or 3 to 28 VDC input and 3 to 52.8 VDC output.
- Two load currents available: 2 A and 3 A
- Flat and vertical models available for a variety of applications.
- Approved by UL and CSA.

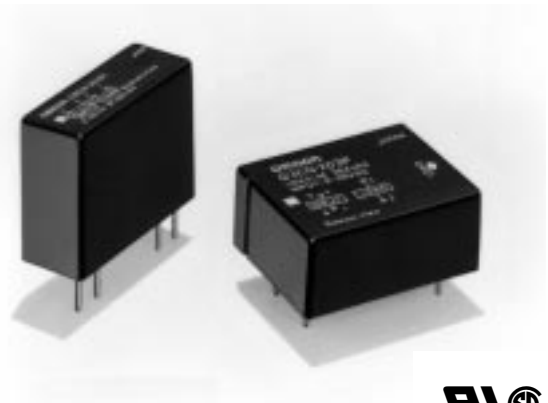

Ordering Information

| Isolation | Zero cross function | Indicator | Rated output voltage (Applicable output load) | Rated input voltage | Model |
|--------------|---------------------|-----------|--|---------------------|-----------------|
| Photocoupler | Yes | No | 2 A at 100 to 240 VAC (2 A at 75 to 264 VAC) | 4 to 24 VDC | G3CN-202P-US |
| | | | | | G3CN-202P1-US* |
| | | | 3 A at 100 to 240 VAC (3 A at 75 to 264 VAC) | | G3CN-203P-US |
| | | | | | G3CN-203P1-US* |
| Phototriac | No | | 2 A at 100 to 240 VAC (2 A at 75 to 264 VAC) | 5, 12, 24 VDC** | G3CN-202PL-US |
| | | | | | G3CN-202PL1-US* |
| | | | 3 A at 100 to 240 VAC (3 A at 75 to 264 VAC) | | G3CN-203PL-US |
| | | | | | G3CN-203PL1-US* |
| Photocoupler | --- | | 2 A at 4 to 48 VDC (2 A at 3 to 52.8 VDC) | 4 to 24 VDC | G3CN-DX02P-US |
| | | | | | G3CN-DX02P1-US* |
| | | | 3 A at 4 to 48 VDC (3 A at 3 to 52.8 VDC) | | G3CN-DX03P-US |
| | | | | | G3CN-DX03P1-US* |

*Vertical models.

**When ordering, specify the input voltage

Specifications

■ Ratings

Input

| Model | Rated voltage | Operating voltage | Impedance | Voltage level | |
|--------------------------------------|---------------|-------------------|---------------------------------|----------------------|----------------------|
| | | | | Must operate voltage | Must release voltage |
| G3CN-202P(1)-US G3CN-203P(1)-US | 4 to 24 VDC | 3 to 28 VDC | 1.5 k Ω $+20\%/_{-10\%}$ | 3 VDC max. | 1 VDC min. |
| G3CN-202PL(1)-US G3CN-203PL(1)-US | 5 VDC | 4 to 6 VDC | 390 $\Omega \pm 20\%$ | 4 VDC max. | |
| | 12 VDC | 9.6 to 14.4 VDC | 900 $\Omega \pm 20\%$ | 9.6 VDC max. | |
| | 24 VDC | 19.2 to 28.8 VDC | 2 k $\Omega \pm 20\%$ | 19.2 VDC max. | |
| G3CN-DX02P(1)-US G3CN-DX03P(1)-US | 4 to 24 VDC | 3 to 28 VDC | 1.5 k Ω $+20\%/_{-10\%}$ | 3 VDC max. | |

Note: The input impedance is measured at the maximum value of the operating voltage. For example, with the model rated at 4 to 24 VDC, the input impedance is measured at 28 VDC.

Output

| Model | Applicable load | | | |
|-------------------------------------|--------------------|--------------------|-------------------|-----------------------|
| | Rated load voltage | Load voltage range | Load current | Inrush current |
| | | | Without heat sink | |
| G3CN-202P(1)-US G3CN-202PL(1)-US | 100 to 240 VAC | 75 to 264 VAC | 0.1 to 2 A | 30 A (60 Hz, 1 cycle) |
| | | | 0.1 to 3 A | 45 A (60 Hz, 1 cycle) |
| G3CN-203P(1)-US G3CN-203PL(1)-US | 4 to 48 VDC | 3 to 52.8 VDC | 0.1 to 2 A | 12 A (10 ms) |
| | | | 0.1 to 3 A | 18 A (10 ms) |

■ Characteristics

| Item | G3CN-202P(1)/203P(1)-US | G3CN-202PL(1)/203PL(1)-US | G3CN-DX02P(1)/03P(1)-US |
|------------------------|---|--|-------------------------|
| Operate time | 1/2 of load power source cycle + 1 ms max. | 1 ms max. | 0.5 ms max. |
| Release time | 1/2 of load power source cycle + 1 ms max. | 1/2 of load power source cycle + 1 ms max. | 2 ms max. |
| Output ON voltage drop | 1.6 V (RMS) max. | | 1.5 V max. |
| Leakage current | 5 mA max. (at 100 VAC) 10 mA max. (at 200 VAC) | 2.5 mA max. (at 100 VAC) 5 mA max. (at 200 VAC) | 5 mA max. (at 50 VDC) |
| Insulation resistance | 100 M Ω min. (at 500 VDC) | | |
| Dielectric strength | 2,500 VAC, 50/60 Hz for 1 min | | |
| Vibration resistance | Malfunction: 10 to 55 Hz, 1.5-mm double amplitude | | |
| Shock resistance | Malfunction: 1,000 m/s ² | | |
| Ambient temperature | Operating: -30°C to 80°C (with no icing nor condensation) Storage: -30°C to 100°C (with no icing nor condensation) | | |
| Ambient humidity | Operating: 45% to 85% | | |
| Approved standards | UL508, UL114 File No.E64562, CSA C22.2 (No.0, No.14) File No. LR35535 | | |
| Weight | Approx. 25 g | | |

Engineering Data

Load Current vs. Ambient Temperature Characteristics

G3CN-202P(1)/-202PL(1)/-DX02P(1)-US

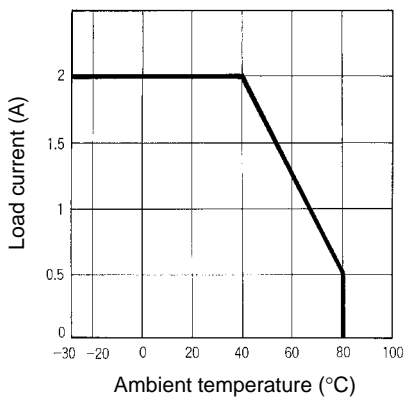

G3CN-203P(1)/-203PL(1)/-DX03P(1)-US

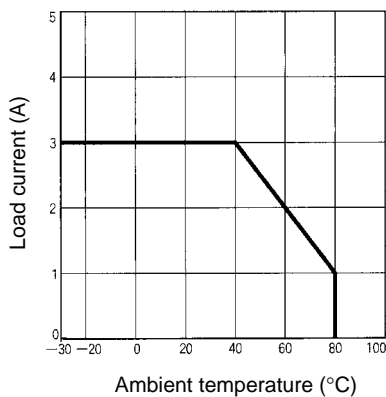

Inrush Current Resistivity

Non-repetitive (Keep the inrush current to half the rated value if it occurs repetitively.)

G3CN-202P(1)/-202PL(1)-US

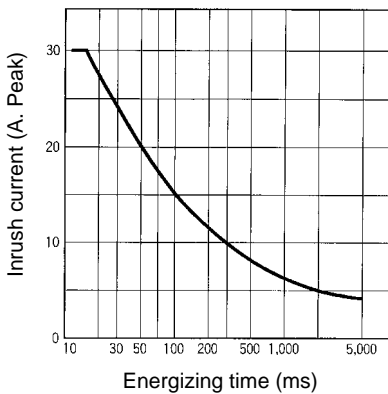

G3CN-DX02P(1)-US

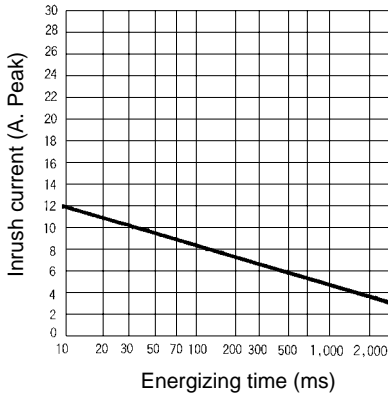

G3CN-203P(1)/-203PL(1)-US

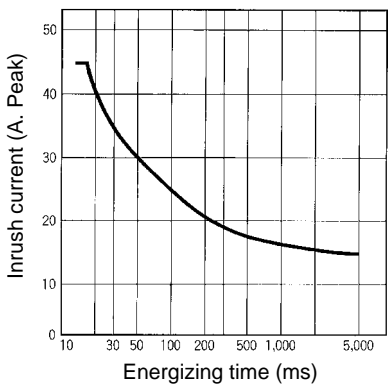

G3CN-DX03P(1)-US

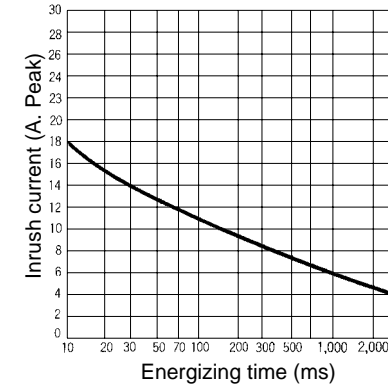

Dimensions

Note: All units are in millimeters unless otherwise indicated.

Flat Model

G3CN-20□P/-20□PL/-DX0□P

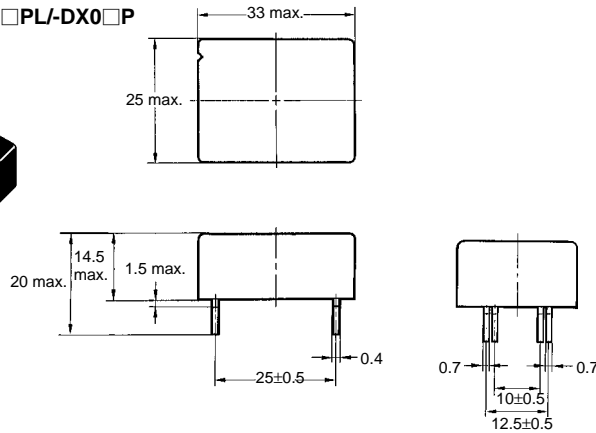
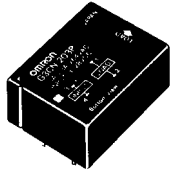

Terminal Arrangement/ Mounting Holes (Bottom View)

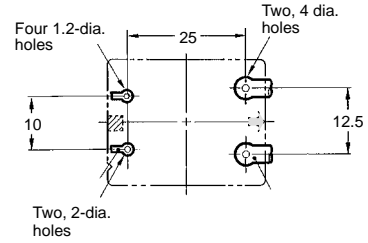

Terminal Arrangement/ Internal Connections (Bottom View)

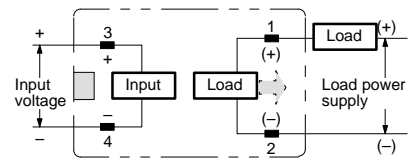

Note: Values in parentheses apply to the DC-load versions.

Vertical Model

G3CN-20□P1/-20□PL1/-DX0□P1

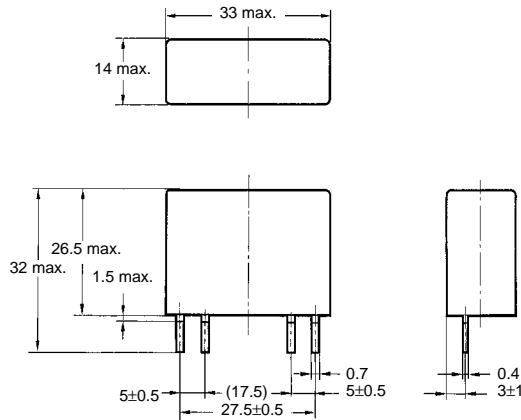
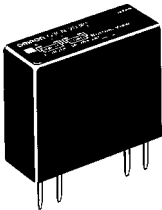

Terminal Arrangement/ Mounting Holes (Bottom View)

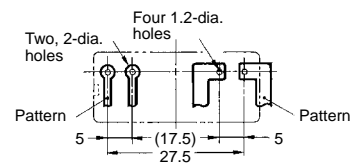

Terminal Arrangement/ Internal Connections (Bottom View)

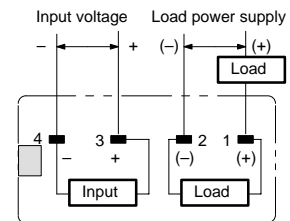

Note: Values in parentheses apply to the DC-load versions.

Precautions

Refer to pages 11 to 19 for general precautions.

Connection

With the SSR for DC switching, the load can be connected to either positive or negative output terminal of the SSR.

Protective Component

Since the SSR does not incorporate an overvoltage absorption component, be sure to connect an overvoltage absorption component when using the SSR under an inductive load.

ALL DIMENSIONS SHOWN ARE IN MILLIMETERS.

To convert millimeters into inches, multiply by 0.03937. To convert grams into ounces, multiply by 0.03527.