



# 78LXX

## LINEAR INTEGRATED CIRCUIT

### 3-TERMINAL 0.1A POSITIVE VOLTAGE REGULATOR

#### DESCRIPTION

The UTC 78LXX family is monolithic fixed voltage regulator integrated circuit. They are suitable for applications that required supply current up to 100mA.

#### FEATURES

- \* Output current up to 100mA
- \* Fixed output voltage of 5V, 6V, 8V, 9V, 10V, 12V, 15V and 18V available
- \* Thermal overload shutdown protection
- \* Short circuit current limiting

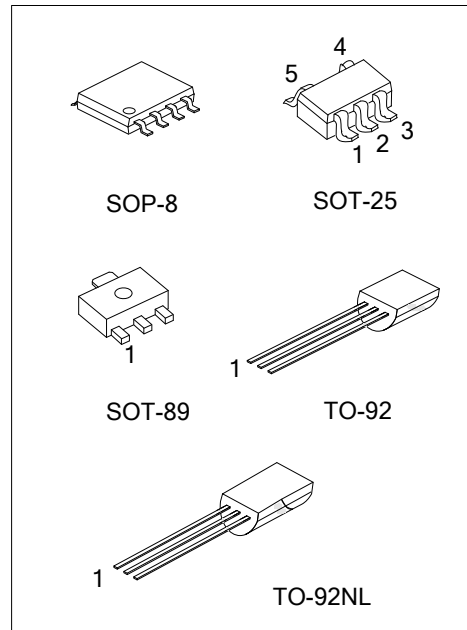

#### ORDERING INFORMATION

Ordering Number		Package	Pin Assignment								Packing
Lead Free	Halogen Free		1	2	3	4	5	6	7	8	
78LXXL-AB3-R	78LXXG-AB3-R	SOT-89	O	G	I	-	-	-	-	-	Tape Reel
78LXXL-AB3-C-R	78LXXG-AB3-C-R	SOT-89	G	I	O	-	-	-	-	-	Tape Reel
78LXXL-AF5-R	78LXXG-AF5-R	SOT-25	G	I	O	N	N				Tape Reel
78LXXL-S08-R	78LXXG-S08-R	SOP-8	O	G	G	N	N	G	G	I	Tape Reel
78LXXL-T92-B	78LXXG-T92-B	TO-92	O	G	I	-	-	-	-	-	Tape Box
78LXXL-T92-K	78LXXG-T92-K	TO-92	O	G	I	-	-	-	-	-	Bulk
78LXXL-T9N-B	78LXXG-T9N-B	TO-92NL	O	G	I	-	-	-	-	-	Tape Box
78LXXL-T9N-K	78LXXG-T9N-K	TO-92NL	O	G	I	-	-	-	-	-	Bulk

Note: 1. XX: Output Voltage, refer to Marking Information.

2. Pin Assignment: O: Output G: GND I: Input N: No Connection

<p>78LXXG-AB3-C-R</p>	<p>(1)Packing Type (2)Pin Assignment (3)Package Type (4)Green Package (5)Output Voltage Code</p>	<p>(1) B: Tape Box, K: Bulk, R: Tape Reel (2) refer to Pin Assignment (3) AB3: SOT-89, AF5: SOT-25, S08: SOP-8, T92: TO-92, T9N: TO-92NL (4) G: Halogen Free and Lead Free, L: Lead Free (5) XX: refer to Marking Information</p>
-----------------------	--	---

### MARKING INFORMATION

PACKAGE	VOLTAGE CODE	MARKING
SOT-89		<p>                     Date Code ← [ ] [ ] [ ] [ ] → Pin Code                      Voltage Code ← 78LXX → L: Lead Free                      G: Halogen Free                 </p>
SOT-25	05:5.0V 06:6.0V	<p>                     Voltage Code ← 8LXX → L: Lead Free                      G: Halogen Free                 </p>
SOP-8	08:8.0V 09:9.0V 10:10V 12:12V	<p>                     Date Code ← UTC [ ] [ ] [ ] [ ] → L: Lead Free                      Voltage Code ← 78LXX → G: Halogen Free                      Lot Code → [ ] [ ]                 </p>
TO-92	15:15V 18:18V	<p>                     Voltage Code ← UTC 78LXX → L: Lead Free                      G: Halogen Free                      Date Code → [ ] [ ]                 </p>
TO-92NL		<p>                     Voltage Code ← UTC 78LXX → L: Lead Free                      G: Halogen Free                      Date Code → [ ] [ ] [ ] [ ]                 </p>

### ■ ABSOLUTE MAXIMUM RATINGS

PARAMETER		SYMBOL	RATINGS	UNIT
Input Voltage	$V_{OUT}=5\sim 9V$	$V_{IN}$	30	V
	$V_{OUT}=10\sim 18V$		35	
Output Current		$I_{OUT}$	100	mA
Power Dissipation	SOT-89	$P_D$	350	mW
	SOT-25		240	mW
	SOP-8		300	mW
	TO-92/TO-92NL		625	mW
Junction Temperature		$T_J$	+150	°C
Operating Temperature (Note 2)		$T_{OPR}$	-40 ~ +125	°C
Storage Temperature		$T_{STG}$	-55 ~ +150	°C

- Notes: 1. Absolute maximum ratings are those values beyond which the device could be permanently damaged. Absolute maximum ratings are stress ratings only and functional device operation is not implied.  
2. It is guarantee by design, not 100% be tested.

### ■ ELECTRICAL CHARACTERISTICS

For UTC78L05 ( $V_{IN}=10V$ ,  $I_{OUT}=40mA$ ,  $0^\circ C < T_J < 150^\circ C$ ,  $C_1=0.33\mu F$ ,  $C_o=0.1\mu F$ , unless otherwise specified)

PARAMETER	SYMBOL	TEST CONDITIONS	MIN	TYP	MAX	UNIT
Output Voltage	$V_{OUT}$	$T_J=25^\circ C$	4.80	5.0	5.20	V
		$7V \leq V_{IN} \leq 20V, I_{OUT}=1mA-40mA$	4.75		5.25	V
		$7V \leq V_{IN} \leq V_{MAX}, I_{OUT}=1mA-70mA$	4.75		5.25	V (note 2)
Load Regulation	$\Delta V_{OUT}$	$T_J=25^\circ C, I_{OUT}=1mA-100mA$		15	60	mV
		$T_J=25^\circ C, I_{OUT}=1mA-40mA$		8	30	mV
Line regulation	$\Delta V_{OUT}$	$7V \leq V_{IN} \leq 20V, T_J=25^\circ C$		8	150	mV
		$8V \leq V_{IN} \leq 20V, T_J=25^\circ C$		6	100	mV
Quiescent Current	$I_Q$	$V_{IN}=10V, I_{OUT}=0mA, T_J=25^\circ C$		2.0	5.5	mA
Quiescent Current Change	$\Delta I_Q$	$8V \leq V_{IN} \leq 20V$			1.5	mA
		$1mA \leq V_{IN} \leq 40mA$			0.1	mA
Output Noise Voltage	eN	$10Hz \leq f \leq 100kHz$		40		$\mu V$
Temperature coefficient of $V_{OUT}$	$\Delta V_O/\Delta T$	$I_{OUT}=5mA$		-0.65		mV/°C
Ripple Rejection	RR	$8V \leq V_{IN} \leq 20V, f=120Hz, T_J=25^\circ C$		60		dB
Dropout Voltage	$V_D$	$T_J=25^\circ C$		1.7		V

For UTC78L06 ( $V_{IN}=12V$ ,  $I_{OUT}=40mA$ ,  $0^\circ C < T_J < 150^\circ C$ ,  $C_1=0.33\mu F$ ,  $C_o=0.1\mu F$ , unless otherwise specified)

PARAMETER	SYMBOL	TEST CONDITIONS	MIN	TYP	MAX	UNIT
Output Voltage	$V_{OUT}$	$T_J=25^\circ C$	5.76	6.0	6.24	V
		$8.5V \leq V_{IN} \leq 20V, I_{OUT}=1mA-40mA$	5.70		6.30	V
		$8.5V \leq V_{IN} \leq V_{MAX}, I_{OUT}=1mA-70mA$	5.70		6.30	V (note 2)
Load Regulation	$\Delta V_{OUT}$	$T_J=25^\circ C, I_{OUT}=1mA-100mA$		16	80	mV
		$T_J=25^\circ C, I_{OUT}=1mA-40mA$		9	40	mV
Line regulation	$\Delta V_{OUT}$	$8.5V \leq V_{IN} \leq 20V, T_J=25^\circ C$		10	175	mV
		$9V \leq V_{IN} \leq 20V, T_J=25^\circ C$		8	125	mV
Quiescent Current	$I_Q$	$V_{IN}=12V, I_{OUT}=0mA, T_J=25^\circ C$		2.0	5.5	mA
Quiescent Current Change	$\Delta I_Q$	$9V \leq V_{IN} \leq 20V$			1.5	mA
		$1mA \leq V_{IN} \leq 40mA$			0.1	mA
Output Noise Voltage	eN	$10Hz \leq f \leq 100kHz$		49		$\mu V$
Temperature coefficient of $V_{OUT}$	$\Delta V_O/\Delta T$	$I_{OUT}=5mA$		-0.75		mV/°C
Ripple Rejection	RR	$10V \leq V_{IN} \leq 20V, f=120Hz, T_J=25^\circ C$		56		dB
Dropout Voltage	$V_D$	$T_J=25^\circ C$		1.7		V

### ■ ELECTRICAL CHARACTERISTICS (Cont.)

For UTC78L08 ( $V_{IN}=14V$ ,  $I_{OUT}=40mA$ ,  $0^{\circ}C < T_J < 150^{\circ}C$ ,  $C_1=0.33\mu F$ ,  $C_o=0.1\mu F$ , unless otherwise specified)

PARAMETER	SYMBOL	TEST CONDITIONS	MIN	TYP	MAX	UNIT
Output Voltage	$V_{OUT}$	$T_J=25^{\circ}C$	7.68	8.0	8.32	V
		$10.5V \leq V_{IN} \leq 23V, I_{OUT}=1mA-40mA$	7.60		8.40	V
		$10.5V \leq V_{IN} \leq V_{MAX}, I_{OUT}=1mA-70mA$	7.60		8.40	V(note 2)
Load Regulation	$\Delta V_{OUT}$	$T_J=25^{\circ}C, I_{OUT}=1mA-100mA$		18	80	mV
		$T_J=25^{\circ}C, I_{OUT}=1mA-40mA$		10	40	mV
Line regulation	$\Delta V_{OUT}$	$10.5V \leq V_{IN} \leq 23V, T_J=25^{\circ}C$		12	175	mV
		$11V \leq V_{IN} \leq 23V, T_J=25^{\circ}C$		10	125	mV
Quiescent Current	$I_Q$	$V_{IN}=14V, I_{OUT}=0mA, T_J=25^{\circ}C$		2.0	5.5	mA
Quiescent Current Change	$\Delta I_Q$	$11V \leq V_{IN} \leq 23V$			1.5	mA
		$1mA \leq V_{IN} \leq 40mA$			0.1	mA
Output Noise Voltage	eN	$10Hz \leq f \leq 100kHz$		49		$\mu V$
Temperature coefficient of $V_o$	$\Delta V_o/\Delta T$	$I_{OUT}=5mA$		-0.75		$mV/^{\circ}C$
Ripple Rejection	RR	$11V \leq V_{IN} \leq 23V, f=120Hz, T_J=25^{\circ}C$		52		dB
Dropout Voltage	$V_D$	$T_J=25^{\circ}C$		1.7		V

For UTC78L09 ( $V_{IN}=15V$ ,  $I_{OUT}=40mA$ ,  $0^{\circ}C < T_J < 150^{\circ}C$ ,  $C_1=0.33\mu F$ ,  $C_o=0.1\mu F$ , unless otherwise specified)

PARAMETER	SYMBOL	TEST CONDITIONS	MIN	TYP	MAX	UNIT
Output Voltage	$V_{OUT}$	$T_J=25^{\circ}C$	8.64	9.0	9.36	V
		$11.5V \leq V_{IN} \leq 24V, I_{OUT}=1mA-40mA$	8.55		9.45	V
		$11.5V \leq V_{IN} \leq V_{MAX}, I_{OUT}=1mA-70mA$	8.55		9.45	V(note 2)
Load Regulation	$\Delta V_{OUT}$	$T_J=25^{\circ}C, I_{OUT}=1mA-100mA$		20	90	mV
		$T_J=25^{\circ}C, I_{OUT}=1mA-40mA$		10	40	mV
Line regulation	$\Delta V_{OUT}$	$11.5V \leq V_{IN} \leq 24V, T_J=25^{\circ}C$		15	200	mV
		$13V \leq V_{IN} \leq 24V, T_J=25^{\circ}C$		10	150	mV
Quiescent Current	$I_Q$	$V_{IN}=15V, I_{OUT}=0mA, T_J=25^{\circ}C$		2.0	6.0	mA
Quiescent Current Change	$\Delta I_Q$	$13V \leq V_{IN} \leq 24V$			1.5	mA
		$1mA \leq V_{IN} \leq 40mA$			0.1	mA
Output Noise Voltage	eN	$10Hz \leq f \leq 100kHz$		70		$\mu V$
Temperature coefficient of $V_{OUT}$	$\Delta V_o/\Delta T$	$I_{OUT}=5mA$		-0.75		$mV/^{\circ}C$
Ripple Rejection	RR	$12V \leq V_{IN} \leq 24V, f=120Hz, T_J=25^{\circ}C$		46		dB
Dropout Voltage	$V_D$	$T_J=25^{\circ}C$		1.7		V

For UTC78L10 ( $V_{IN}=16V$ ,  $I_{OUT}=40mA$ ,  $0^{\circ}C < T_J < 150^{\circ}C$ ,  $C_1=0.33\mu F$ ,  $C_o=0.1\mu F$ , unless otherwise specified)

PARAMETER	SYMBOL	TEST CONDITIONS	MIN	TYP	MAX	UNIT
Output Voltage	$V_{OUT}$	$T_J=25^{\circ}C$	9.6	10.0	10.4	V
		$12.5V \leq V_{IN} \leq 25V, I_{OUT}=1mA-40mA$	9.5		10.5	V
		$12.5V \leq V_{IN} \leq V_{MAX}, I_{OUT}=1mA-70mA$	9.5		10.5	V(note 2)
Load Regulation	$\Delta V_{OUT}$	$T_J=25^{\circ}C, I_{OUT}=1mA-100mA$		20	90	mV
		$T_J=25^{\circ}C, I_{OUT}=1mA-40mA$		10	45	mV
Line regulation	$\Delta V_{OUT}$	$12.5V \leq V_{IN} \leq 25V, T_J=25^{\circ}C$		25	200	mV
		$14V \leq V_{IN} \leq 25V, T_J=25^{\circ}C$		20	170	mV
Quiescent Current	$I_Q$	$V_{IN}=17V, I_{OUT}=0mA, T_J=25^{\circ}C$		2.0	6.0	mA
Quiescent Current Change	$\Delta I_Q$	$12.5V \leq V_{IN} \leq 25V$			1.5	mA
		$1mA \leq V_{IN} \leq 40mA$			0.1	mA
Output Noise Voltage	eN	$10Hz \leq f \leq 100kHz$		74		$\mu V$
Temperature coefficient of $V_{OUT}$	$\Delta V_o/\Delta T$	$I_{OUT}=5mA$		-0.8		$mV/^{\circ}C$
Ripple Rejection	RR	$15V \leq V_{IN} \leq 25V, f=120Hz, T_J=25^{\circ}C$		45		dB
Dropout Voltage	$V_D$	$T_J=25^{\circ}C$		1.7		V

### ■ ELECTRICAL CHARACTERISTICS (Cont.)

For UTC78L12 ( $V_{IN}=19V$ ,  $I_{OUT}=40mA$ ,  $0^{\circ}C < T_J < 150^{\circ}C$ ,  $C_1=0.33\mu F$ ,  $C_o=0.1\mu F$ , unless otherwise specified)

PARAMETER	SYMBOL	TEST CONDITIONS	MIN	TYP	MAX	UNIT
Output Voltage	$V_{OUT}$	$T_J=25^{\circ}C$	11.52	12.0	12.48	V
		$14.5V \leq V_{IN} \leq 27V, I_{OUT}=1mA-40mA$	11.40		12.60	V
		$14.5V \leq V_{IN} \leq V_{MAX}, I_{OUT}=1mA-70mA$	11.40		12.60	V(note 2)
Load Regulation	$\Delta V_{OUT}$	$T_J=25^{\circ}C, I_{OUT}=1mA-100mA$		25	100	mV
		$T_J=25^{\circ}C, I_{OUT}=1mA-40mA$		12	50	mV
Line regulation	$\Delta V_{OUT}$	$14.5V \leq V_{IN} \leq 27V, T_J=25^{\circ}C$		25	300	mV
		$16V \leq V_{IN} \leq 27V, T_J=25^{\circ}C$		20	250	mV
Quiescent Current	$I_Q$	$V_{IN}=19V, I_{OUT}=0mA, T_J=25^{\circ}C$		2.0	6.5	mA
Quiescent Current Change	$\Delta I_Q$	$16V \leq V_{IN} \leq 27V$			1.5	mA
		$1mA \leq V_{IN} \leq 40mA$			0.1	mA
Output Noise Voltage	eN	$10Hz \leq f \leq 100kHz$		80		$\mu V$
Temperature coefficient of $V_{OUT}$	$\Delta V_O/\Delta T$	$I_{OUT}=5mA$		-1.0		$mV/^{\circ}C$
Ripple Rejection	RR	$15V \leq V_{IN} \leq 25V, f=120Hz, T_J=25^{\circ}C$		45		dB
Dropout Voltage	$V_D$	$T_J=25^{\circ}C$		1.7		V

For UTC78L15 ( $V_{IN}=23V$ ,  $I_{OUT}=40mA$ ,  $0^{\circ}C < T_J < 150^{\circ}C$ ,  $C_1=0.33\mu F$ ,  $C_o=0.1\mu F$ , unless otherwise specified)

PARAMETER	SYMBOL	TEST CONDITIONS	MIN	TYP	MAX	UNIT
Output Voltage	$V_{OUT}$	$T_J=25^{\circ}C$	14.40	15.0	15.60	V
		$17.5V \leq V_{IN} \leq 30V, I_{OUT}=1mA-40mA$	14.25		15.75	V
		$17.5V \leq V_{IN} \leq V_{MAX}, I_{OUT}=1mA-70mA$	14.25		15.75	V(note 2)
Load Regulation	$\Delta V_{OUT}$	$T_J=25^{\circ}C, I_{OUT}=1mA-100mA$		25	150	mV
		$T_J=25^{\circ}C, I_{OUT}=1mA-40mA$		15	75	mV
Line Regulation	$\Delta V_{OUT}$	$17.5V \leq V_{IN} \leq 30V, T_J=25^{\circ}C$		25	150	mV
		$20V \leq V_{IN} \leq 30V, T_J=25^{\circ}C$		15	75	mV
Quiescent Current	$I_Q$	$V_{IN}=23V, I_{OUT}=0mA, T_J=25^{\circ}C$		2.2	6.5	mA
Quiescent Current Change	$\Delta I_Q$	$20V \leq V_{IN} \leq 30V$			1.5	mA
		$1mA \leq V_{IN} \leq 40mA$			0.1	mA
Output Noise Voltage	eN	$10Hz \leq f \leq 100kHz$		90		$\mu V$
Temperature Coefficient of $V_{OUT}$	$\Delta V_O/\Delta T$	$I_{OUT}=5mA$		-1.3		$mV/^{\circ}C$
Ripple Rejection	RR	$18.5V \leq V_{IN} \leq 28.5V, f=120Hz, T_J=25^{\circ}C$		45		dB
Dropout Voltage	$V_D$	$T_J=25^{\circ}C$		1.7		V

For UTC78L18 ( $V_{IN}=27V$ ,  $I_{OUT}=40mA$ ,  $0^{\circ}C < T_J < 150^{\circ}C$ ,  $C_1=0.33\mu F$ ,  $C_o=0.1\mu F$ , unless otherwise specified)

PARAMETER	SYMBOL	TEST CONDITIONS	MIN	TYP	MAX	UNIT
Output Voltage	$V_{OUT}$	$T_J=25^{\circ}C$	17.28	18.0	18.72	V
		$21V \leq V_{IN} \leq 33V, I_{OUT}=1mA-40mA$	17.10		18.90	V
		$21V \leq V_{IN} \leq V_{MAX}, I_{OUT}=1mA-70mA$	17.46		18.54	V(note 2)
Load Regulation	$\Delta V_{OUT}$	$T_J=25^{\circ}C, I_{OUT}=1mA-100mA$		30	180	mV
		$T_J=25^{\circ}C, I_{OUT}=1mA-40mA$		20	90	mV
Line Regulation	$\Delta V_{OUT}$	$21V \leq V_{IN} \leq 33V, T_J=25^{\circ}C$		45	300	mV
		$22V \leq V_{IN} \leq 33V, T_J=25^{\circ}C$		35	250	mV
Quiescent Current	$I_Q$	$V_{IN}=27V, I_{OUT}=0mA, T_J=25^{\circ}C$		2.2	6.5	mA
Quiescent Current Change	$\Delta I_Q$	$21V \leq V_{IN} \leq 33V$			1.5	mA
		$1mA \leq V_{IN} \leq 40mA$			0.1	mA
Output Noise Voltage	eN	$10Hz \leq f \leq 100kHz$		150		$\mu V$
Temperature Coefficient of $V_{OUT}$	$\Delta V_O/\Delta T$	$I_{OUT}=5mA$		-1.8		$mV/^{\circ}C$
Ripple Rejection	RR	$23V \leq V_{IN} \leq 33V, f=120Hz, T_J=25^{\circ}C$		45		dB
Dropout Voltage	$V_D$	$T_J=25^{\circ}C$		1.7		V

Note 1. The Maximum steady state usable output current is dependent on input voltage, heat sinking, lead length of the package and copper pattern of PCB.

2. Power dissipation  $< 0.5W$

## APPLICATION CIRCUIT

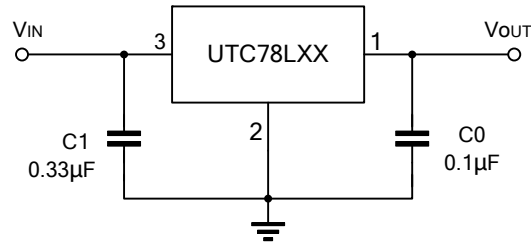

- Notes:
1. To specify an output voltage, substitute voltage value for "XX".
  2. Bypass capacitors are recommended for optimum stability and transient response and should be located as close as possible to the regulators.

## TEST CIRCUIT

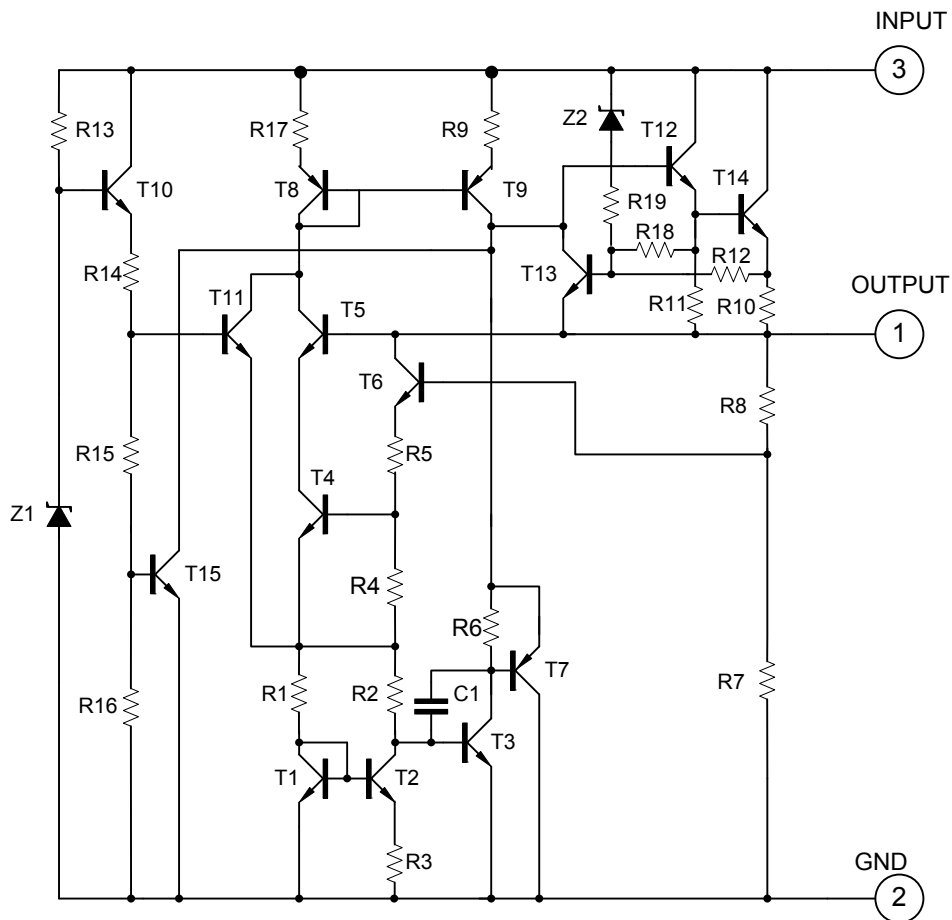

## ■ TYPICAL CHARACTERISTICS

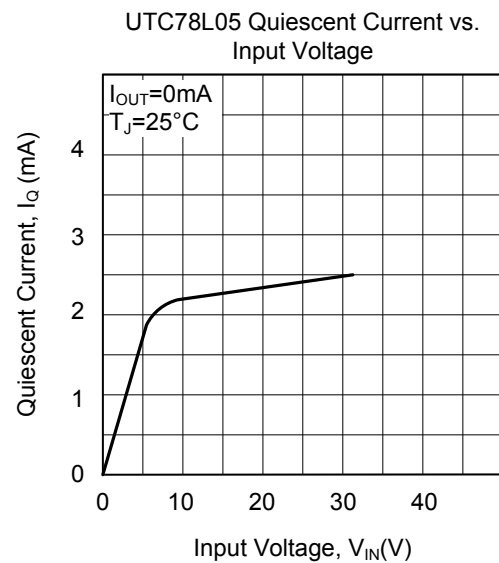
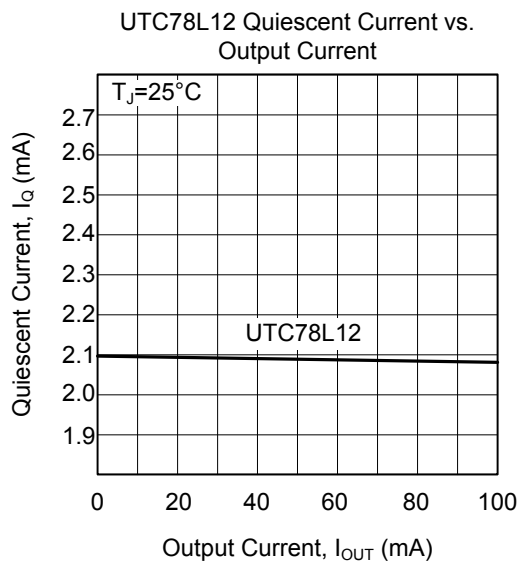
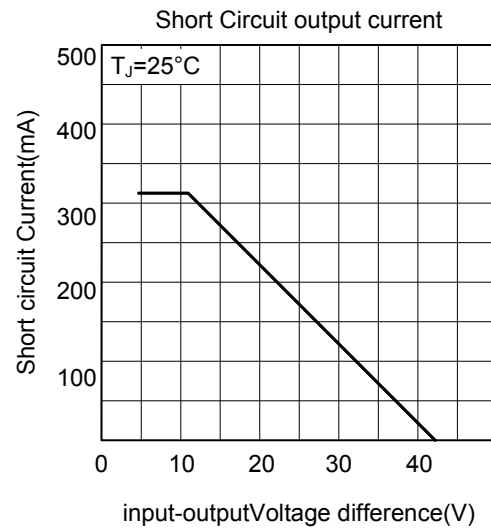
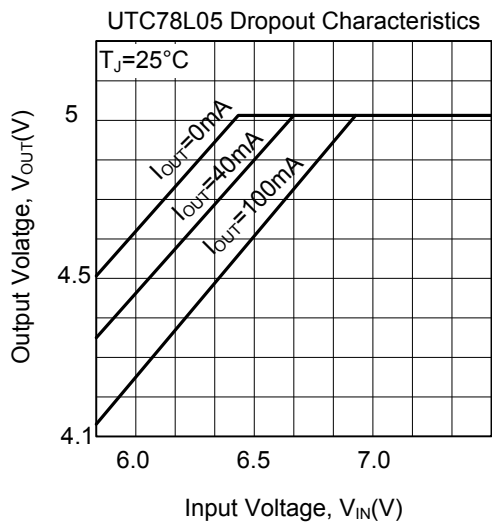
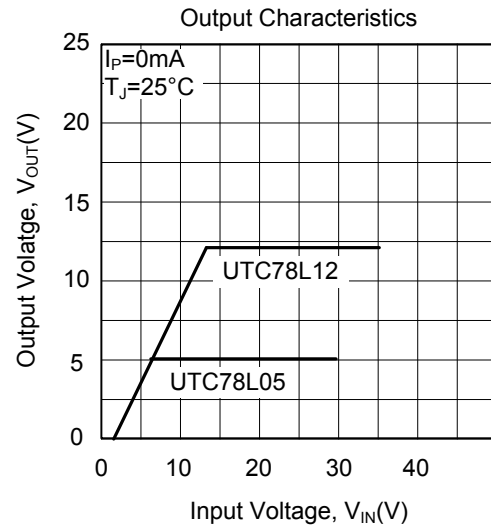
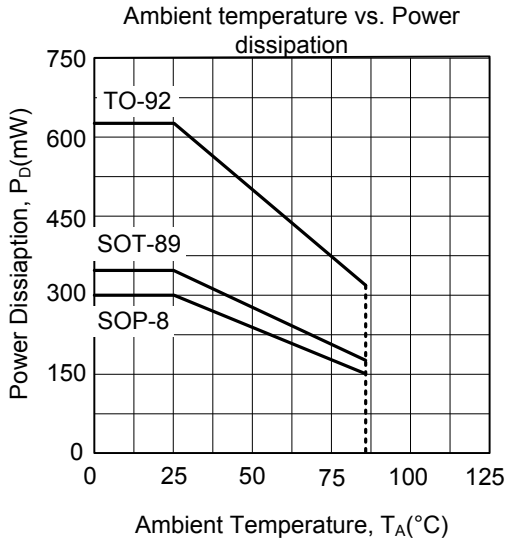

■ TYPICAL CHARACTERISTICS (Cont.)

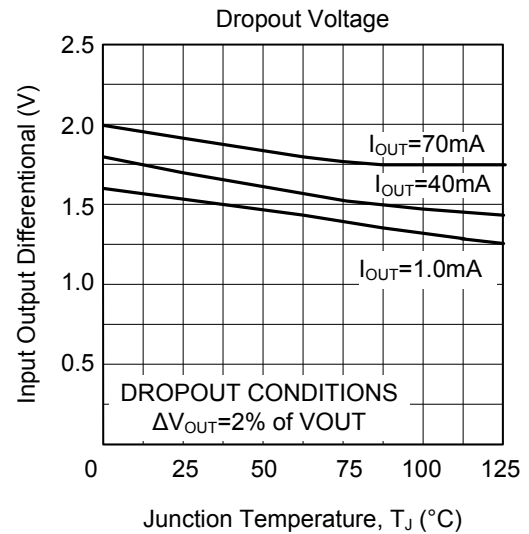
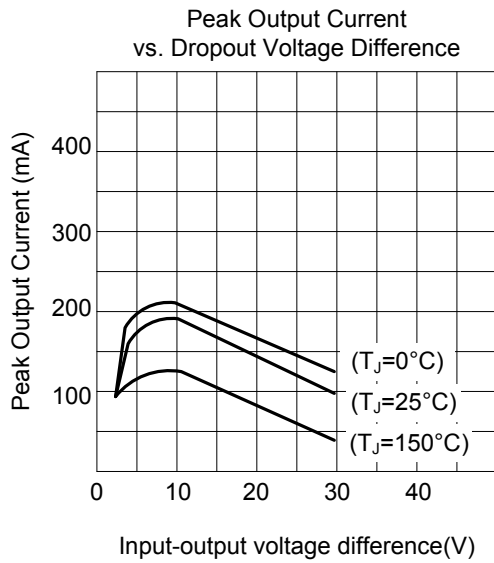

UTC assumes no responsibility for equipment failures that result from using products at values that exceed, even momentarily, rated values (such as maximum ratings, operating condition ranges, or other parameters) listed in products specifications of any and all UTC products described or contained herein. UTC products are not designed for use in life support appliances, devices or systems where malfunction of these products can be reasonably expected to result in personal injury. Reproduction in whole or in part is prohibited without the prior written consent of the copyright owner. UTC reserves the right to make changes to information published in this document, including without limitation specifications and product descriptions, at any time and without notice. This document supersedes and replaces all information supplied prior to the publication hereof.