

**KK74AC253**

**Dual 4-Input Data Selector/Multiplexer  
with 3-State Outputs  
High-Speed Silicon-Gate CMOS**

The KK74AC253 is identical in pinout to the LS/ALS253, HC/HCT253. The device inputs are compatible with standard CMOS outputs; with pullup resistors, they are compatible with LS/ALS outputs.

The Address Inputs select one of four Data Inputs from each multiplexer. Each multiplexer has an active-low Output Enable control and a three-state noninverting output.

- Outputs Directly Interface to CMOS, NMOS, and TTL
- Operating Voltage Range: 2.0 to 6.0 V
- Low Input Current: 1.0  $\mu$ A; 0.1  $\mu$ A @ 25°C
- High Noise Immunity Characteristic of CMOS Devices
- Outputs Source/Sink 24 mA

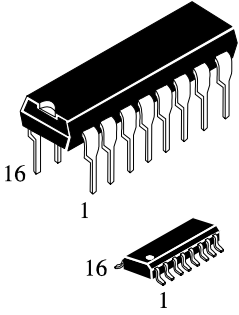

N SUFFIX  
PLASTIC

D SUFFIX  
SOIC

**ORDERING INFORMATION**  
 KK74AC253N Plastic  
 KK74AC253D SOIC  
 $T_A = -40^\circ$  to  $85^\circ$  C for all packages

**LOGIC DIAGRAM**

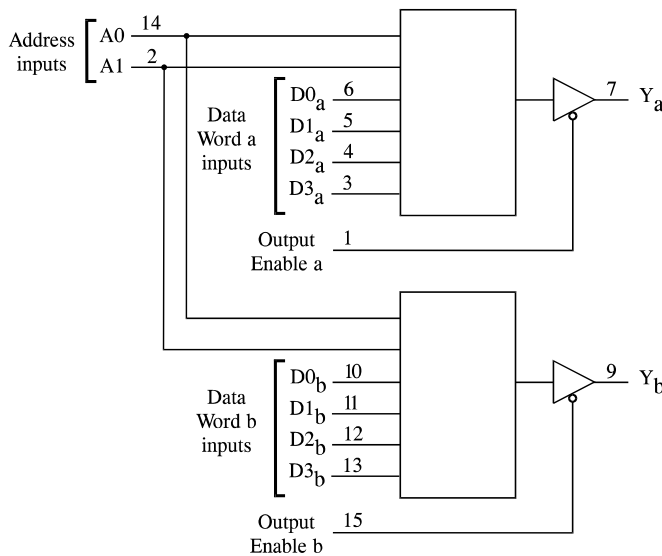

PIN 16 =  $V_{CC}$   
 PIN 8 = GND

**PIN ASSIGNMENT**

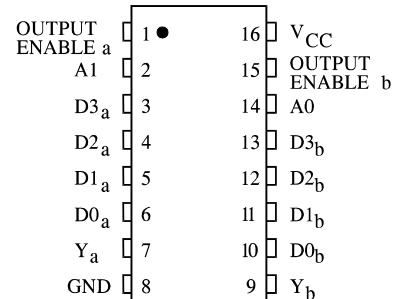

**FUNCTION TABLE**

Inputs			Output
A1	A0	Output Enable	Y
X	X	H	Z
L	L	L	D0
L	H	L	D1
H	L	L	D2
H	H	L	D3

D0,D1...D3=the level of the respective Data Input

Z = high impedance

X = don't care

**MAXIMUM RATINGS\***

Symbol	Parameter	Value	Unit
$V_{CC}$	DC Supply Voltage (Referenced to GND)	-0.5 to +7.0	V
$V_{IN}$	DC Input Voltage (Referenced to GND)	-0.5 to $V_{CC} + 0.5$	V
$V_{OUT}$	DC Output Voltage (Referenced to GND)	-0.5 to $V_{CC} + 0.5$	V
$I_{IN}$	DC Input Current, per Pin	$\pm 20$	mA
$I_{OUT}$	DC Output Sink/Source Current, per Pin	$\pm 50$	mA
$I_{CC}$	DC Supply Current, $V_{CC}$ and GND Pins	$\pm 50$	mA
$P_D$	Power Dissipation in Still Air, Plastic DIP+ SOIC Package+	750 500	mW
Tstg	Storage Temperature	-65 to +150	$^{\circ}\text{C}$
$T_L$	Lead Temperature, 1 mm from Case for 10 Seconds (Plastic DIP or SOIC Package)	260	$^{\circ}\text{C}$

\*Maximum Ratings are those values beyond which damage to the device may occur. Functional operation should be restricted to the Recommended Operating Conditions.

+Derating - Plastic DIP: - 10 mW/ $^{\circ}\text{C}$  from 65 $^{\circ}$  to 125 $^{\circ}\text{C}$   
SOIC Package: - 7 mW/ $^{\circ}\text{C}$  from 65 $^{\circ}$  to 125 $^{\circ}\text{C}$

**RECOMMENDED OPERATING CONDITIONS**

Symbol	Parameter	Min	Max	Unit
$V_{CC}$	DC Supply Voltage (Referenced to GND)	2.0	6.0	V
$V_{IN}, V_{OUT}$	DC Input Voltage, Output Voltage (Referenced to GND)	0	$V_{CC}$	V
$T_J$	Junction Temperature (PDIP)		140	$^{\circ}\text{C}$
$T_A$	Operating Temperature, All Package Types	-40	+85	$^{\circ}\text{C}$
$I_{OH}$	Output Current - High		-24	mA
$I_{OL}$	Output Current - Low		24	mA
$t_r, t_f$	Input Rise and Fall Time * (except Schmitt Inputs)			ns/V
	$V_{CC} = 3.0\text{ V}$	0	150	
	$V_{CC} = 4.5\text{ V}$	0	40	
	$V_{CC} = 5.5\text{ V}$	0	25	

\*  $V_{IN}$  from 30% to 70%  $V_{CC}$

This device contains protection circuitry to guard against damage due to high static voltages or electric fields. However, precautions must be taken to avoid applications of any voltage higher than maximum rated voltages to this high-impedance circuit. For proper operation,  $V_{IN}$  and  $V_{OUT}$  should be constrained to the range  $\text{GND} \leq (V_{IN} \text{ or } V_{OUT}) \leq V_{CC}$ .

Unused inputs must always be tied to an appropriate logic voltage level (e.g., either GND or  $V_{CC}$ ). Unused outputs must be left open.

**DC ELECTRICAL CHARACTERISTICS** (Voltages Referenced to GND)

Symbol	Parameter	Test Conditions	V <sub>CC</sub> V	Guaranteed Limits		Unit
				25 °C	-40°C to 85°C	
V <sub>IH</sub>	Minimum High-Level Input Voltage	V <sub>OUT</sub> =0.1 V or V <sub>CC</sub> -0.1 V	3.0 4.5 5.5	2.1 3.15 3.85	2.1 3.15 3.85	V
V <sub>IL</sub>	Maximum Low - Level Input Voltage	V <sub>OUT</sub> =0.1 V or V <sub>CC</sub> -0.1 V	3.0 4.5 5.5	0.9 1.35 1.65	0.9 1.35 1.65	V
V <sub>OH</sub>	Minimum High-Level Output Voltage	I <sub>OUT</sub> ≤ -50 μA	3.0	2.9	2.9	V
			4.5	4.4	4.4	
			5.5	5.4	5.4	
		*V <sub>IN</sub> = V <sub>IH</sub> or V <sub>IL</sub> I <sub>OH</sub> =-12 mA		3.0	2.56	2.46
I <sub>OH</sub> =-24 mA		4.5	3.86	3.76		
I <sub>OH</sub> =-24 mA		5.5	4.86	4.76		
V <sub>OL</sub>	Maximum Low-Level Output Voltage	I <sub>OUT</sub> ≤ 50 μA	3.0	0.1	0.1	V
			4.5	0.1	0.1	
			5.5	0.1	0.1	
		*V <sub>IN</sub> =V <sub>IH</sub> or V <sub>IL</sub> I <sub>OL</sub> =12 mA		3.0	0.36	0.44
I <sub>OL</sub> =24 mA		4.5	0.36	0.44		
I <sub>OL</sub> =24 mA		5.5	0.36	0.44		
I <sub>IN</sub>	Maximum Input Leakage Current	V <sub>IN</sub> =V <sub>CC</sub> or GND	5.5	±0.1	±1.0	μA
I <sub>OZ</sub>	Maximum Three-State Leakage Current	V <sub>IN</sub> (OE)= V <sub>IH</sub> or V <sub>IL</sub> V <sub>IN</sub> =V <sub>CC</sub> or GND V <sub>OUT</sub> =V <sub>CC</sub> or GND	5.5	±0.5	±5.0	μA
I <sub>OLD</sub>	+Minimum Dynamic Output Current	V <sub>OLD</sub> =1.65 V Max	5.5		75	mA
I <sub>OHD</sub>	+Minimum Dynamic Output Current	V <sub>OHD</sub> =3.85 V Min	5.5		-75	mA
I <sub>CC</sub>	Maximum Quiescent Supply Current (per Package)	V <sub>IN</sub> =V <sub>CC</sub> or GND	5.5	8.0	80	μA

\* All outputs loaded; thresholds on input associated with output under test.

+Maximum test duration 2.0 ms, one output loaded at a time.

Note: I<sub>IN</sub> and I<sub>CC</sub> @ 3.0 V are guaranteed to be less than or equal to the respective limit @ 5.5 V V<sub>CC</sub>

**AC ELECTRICAL CHARACTERISTICS** ( $C_L=50\text{pF}$ , Input  $t_r=t_f=3.0\text{ ns}$ )

Symbol	Parameter	$V_{CC}^*$ V	Guaranteed Limits				Unit
			25 °C		-40°C to 85°C		
			Min	Max	Min	Max	
$t_{PLH}$	Propagation Delay, Address to Output Y (Figure 1)	3.3 5.0	2.0 2.0	15.5 11.0	2.0 1.5	17.5 12.5	ns
$t_{PHL}$	Propagation Delay, Address to Output Y (Figure 1)	3.3 5.0	2.5 2.0	16.0 11.5	2.0 1.5	18.0 13.0	ns
$t_{PLH}$	Propagation Delay, Data to Output Y (Figure 1)	3.3 5.0	1.5 1.5	14.5 10.0	1.5 1.5	17.0 11.5	ns
$t_{PHL}$	Propagation Delay, Data to Output Y (Figure 1)	3.3 5.0	2.0 1.5	13.0 9.5	1.5 1.5	15.0 11.0	ns
$t_{PZH}$	Propagation Delay, Output Enable to Y (Figure 2)	3.3 5.0	1.5 1.5	8.0 6.0	1.0 1.0	8.5 6.5	ns
$t_{PZL}$	Propagation Delay, Output Enable to Y (Figure 2)	3.3 5.0	1.5 1.5	8.0 6.0	1.0 1.0	9.0 7.0	ns
$t_{PHZ}$	Propagation Delay, Output Enable to Y (Figure 2)	3.3 5.0	2.0 2.0	9.5 8.0	1.5 1.5	10.0 8.5	ns
$t_{PLZ}$	Propagation Delay, Output Enable to Y (Figure 2)	3.3 5.0	1.5 1.5	8.0 7.0	1.0 1.0	9.0 7.5	ns
$C_{IN}$	Maximum Input Capacitance	5.0	4.5		4.5		pF

$C_{PD}$	Power Dissipation Capacitance	Typical @25°C, $V_{CC}=5.0\text{ V}$		pF
		50		

\*Voltage Range 3.3 V is 3.3 V  $\pm$ 0.3 V  
Voltage Range 5.0 V is 5.0 V  $\pm$ 0.5 V

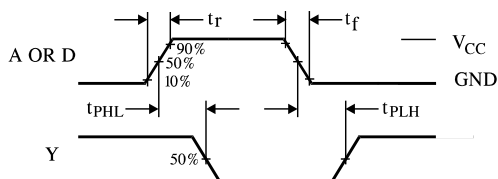

**Figure 1. Switching Waveforms**

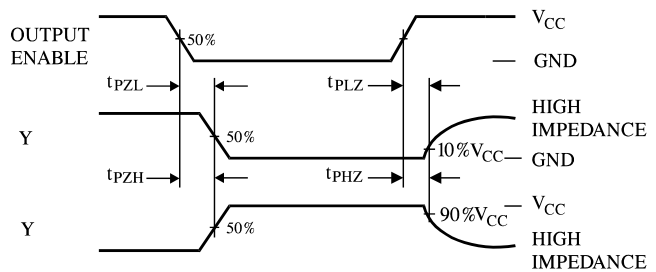

**Figure 2. Switching Waveforms**



**N SUFFIX PLASTIC DIP  
(MS - 001BB)**

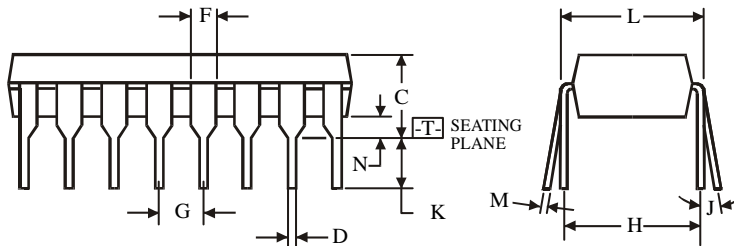
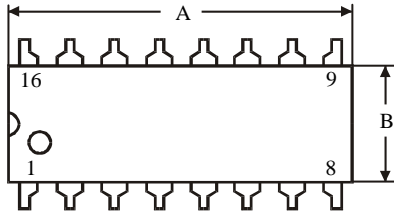
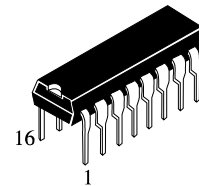

$\oplus 0.25 (0.010) \text{M} \text{T}$

**NOTES:**

- Dimensions "A", "B" do not include mold flash or protrusions.  
Maximum mold flash or protrusions 0.25 mm (0.010) per side.

Symbol	Dimension, mm	
	MIN	MAX
A	18.67	19.69
B	6.1	7.11
C		5.33
D	0.36	0.56
F	1.14	1.78
G	2.54	
H	7.62	
J	0°	10°
K	2.92	3.81
L	7.62	8.26
M	0.2	0.36
N	0.38	

**D SUFFIX SOIC  
(MS - 012AC)**

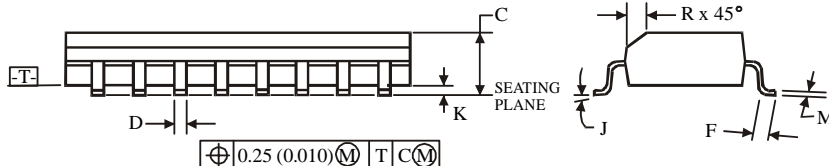
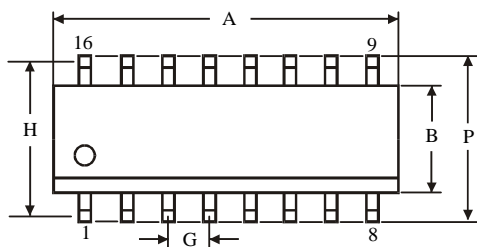
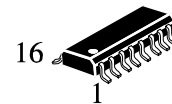

$\oplus 0.25 (0.010) \text{M} \text{T} \text{C} \text{M}$

**NOTES:**

- Dimensions A and B do not include mold flash or protrusion.
- Maximum mold flash or protrusion 0.15 mm (0.006) per side for A; for B - 0.25 mm (0.010) per side.

Symbol	Dimension, mm	
	MIN	MAX
A	9.8	10
B	3.8	4
C	1.35	1.75
D	0.33	0.51
F	0.4	1.27
G	1.27	
H	5.72	
J	0°	8°
K	0.1	0.25
M	0.19	0.25
P	5.8	6.2
R	0.25	0.5