



CA.69

Specification

Part No.	CA.69
Product Name	169 MHz VHF Ceramic Chip Monopole Antenna
Feature	25.2mm * 5.1mm * 0.8mm Efficiency 10~15% (on evaluation board) Peak Gain - approx -7 dBi (on evaluation board) Low profile Compact Size RoHS Compliant

1. Introduction

The CA.69 Ceramic Chip antenna from Taoglas 169 MHz is specifically designed for VHF 169MHz band applications. It is a high efficiency miniature SMD edge mounted antenna with small footprint requirement.

This chip antenna uses the main PCB as its ground plane, thereby increasing antenna efficiency. It is tuned for different PCB sizes by simply changing the value of the matching circuit. CA.69 antenna electrical properties are symmetrical therefore the antenna can be soldered to the board from either side.

This antenna is delivered on tape and reel. Small low frequency antennas such as CA.69 need to be carefully tuned and integrated into devices to perform optimally given the narrow band tuning required, so contact your regional Taoglas sales office for support on gerber review of your layout, advice on ground-plane layout and transmission line design.

Taoglas also recommends we test your final device prototype with CA.69 on board and provide final matching values.

Taoglas has tested the CA.69 mounted in realistic conditions in metal or semi metal meter housings with the latest high power modules from Telit and achieved read ranges of more than one hundred metres.

Applications

VHF Band Applications

2. Specification

Electrical

Center Frequency	169MHz
Bandwidth	8MHz (under -10dB Return Loss)
VSWR	2 max.
Impedance	50Ω
Polarization	Linear

Mechanical

Dimensions (mm)	25.2*5.1*0.8
Ground plane (mm)	110*55mm

Environmental

Temperature Range	-40°C to 85°C
Relative Humidity	20% to 70%

3. Return Loss

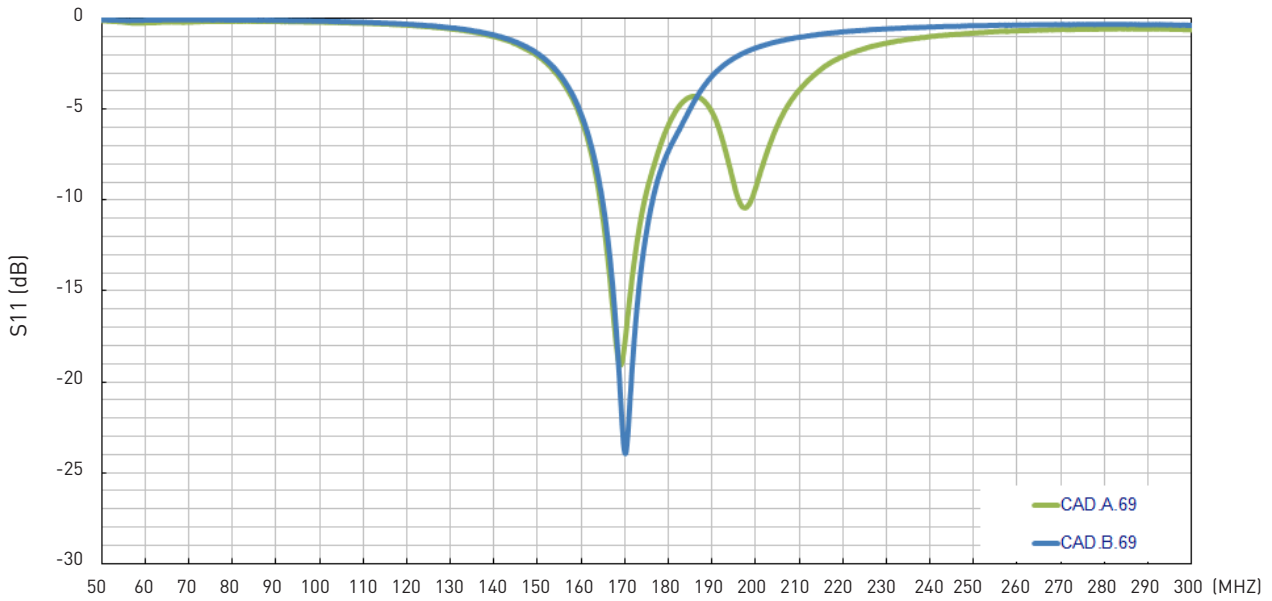

* The antenna tuning depends on different antenna ground plane application. Taoglas provides CAD.A.69 and CAD.B.69 evaluation boards to show performance when antenna is parallel mounted to the ground plane or when it is orthogonally mounted to the ground-plane.



4. Antenna Characteristics

4.1 Antenna Efficiency

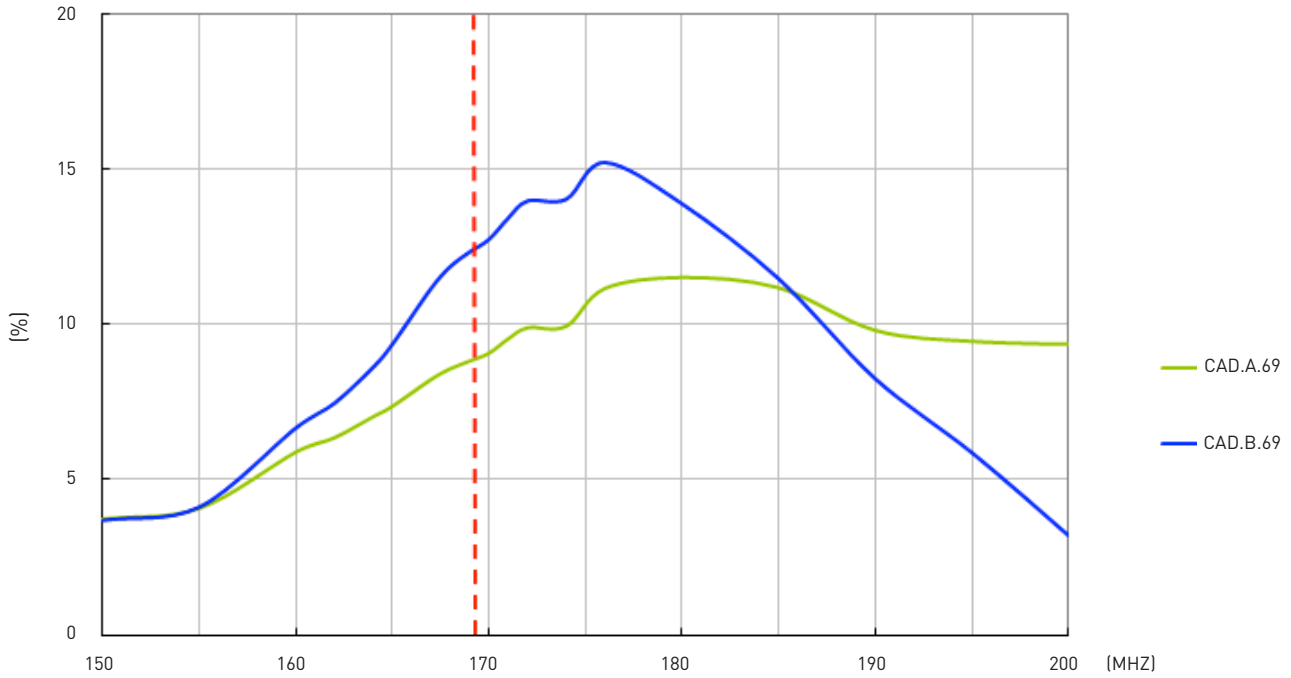

4.2 Antenna Peak Gain

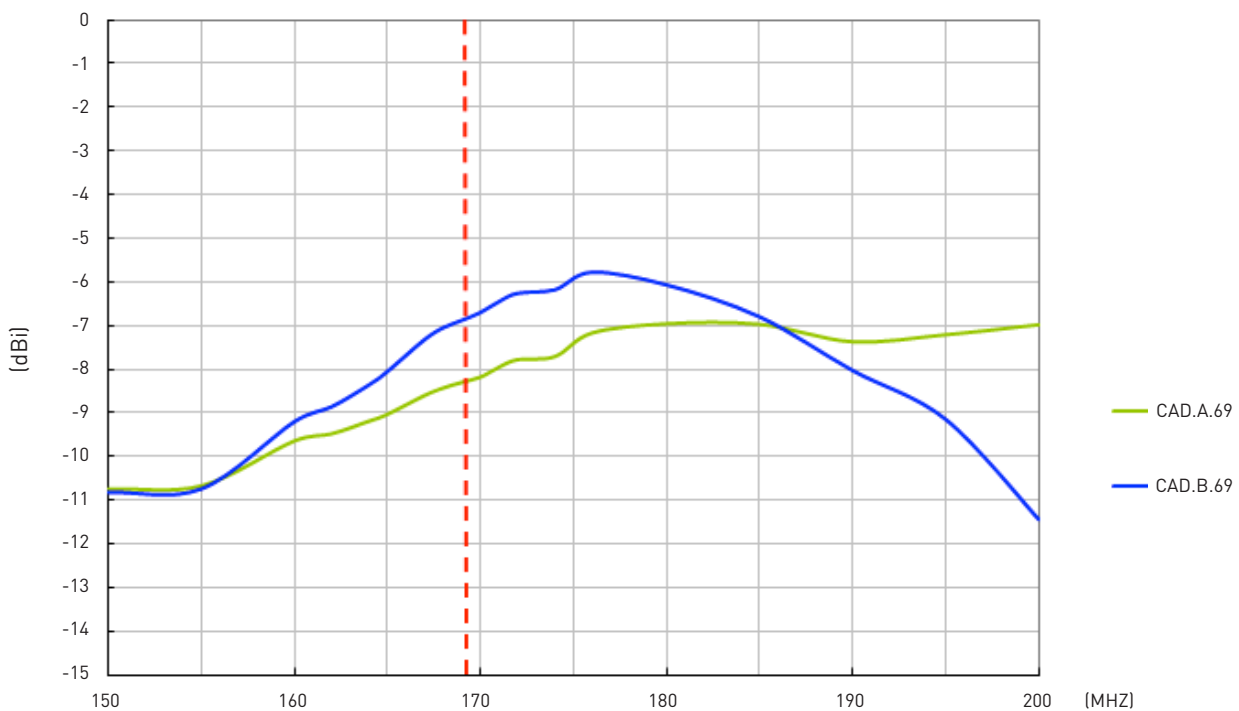

5. Antenna Radiation Pattern

CAD.A.69

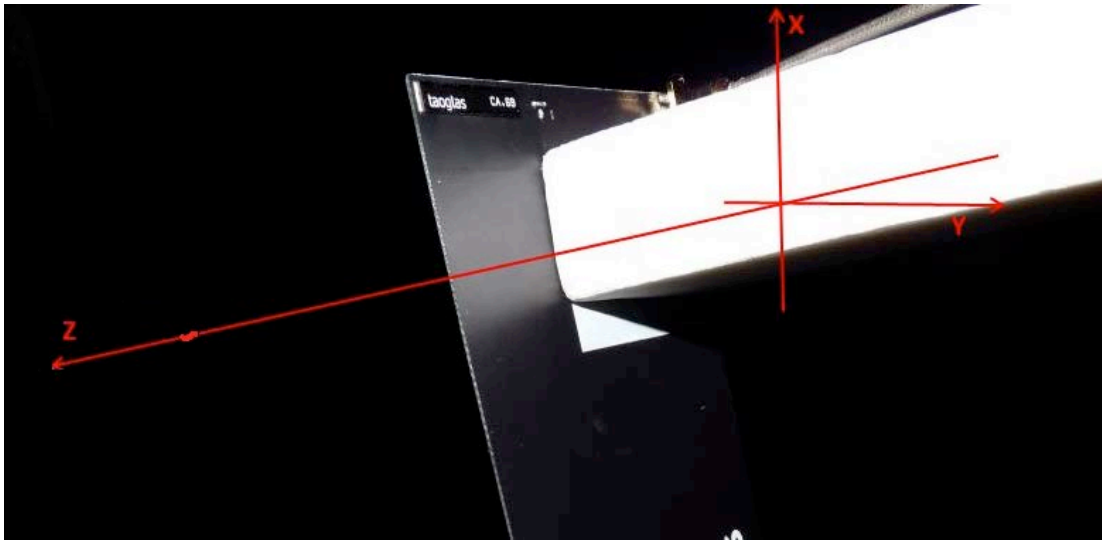

XY Plane

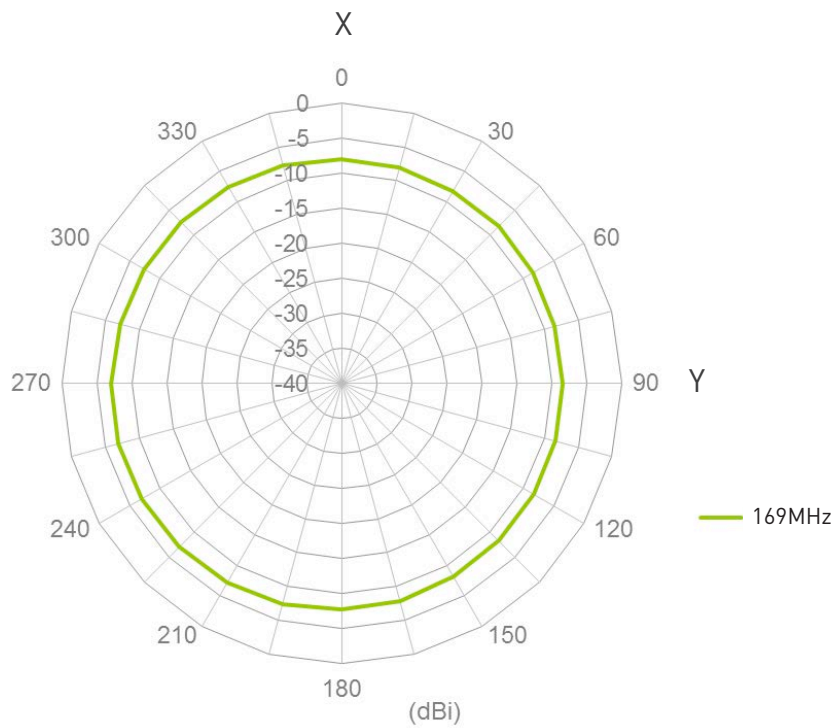

5. Antenna Radiation Pattern

XZ Plane

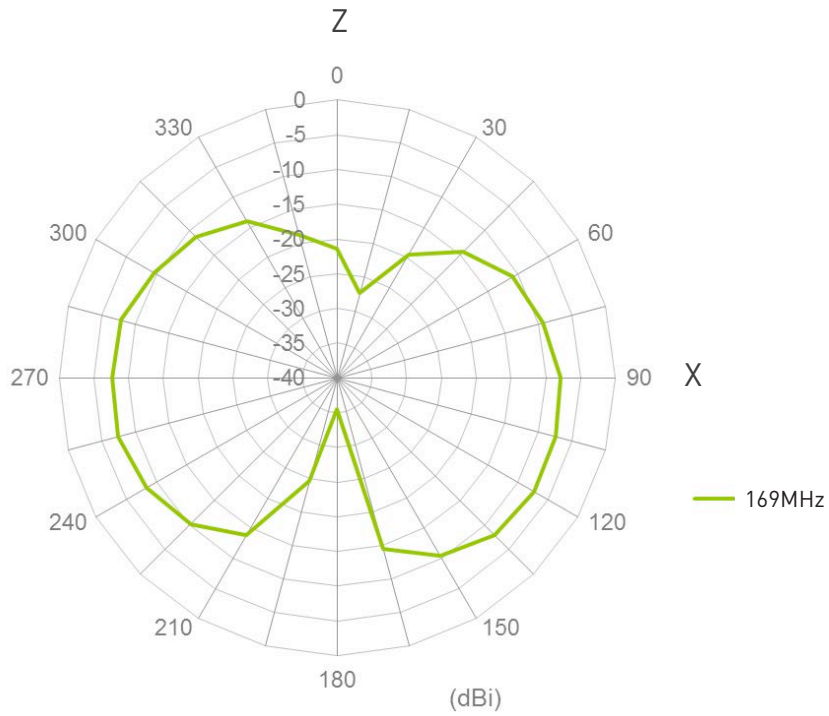

YZ Plane

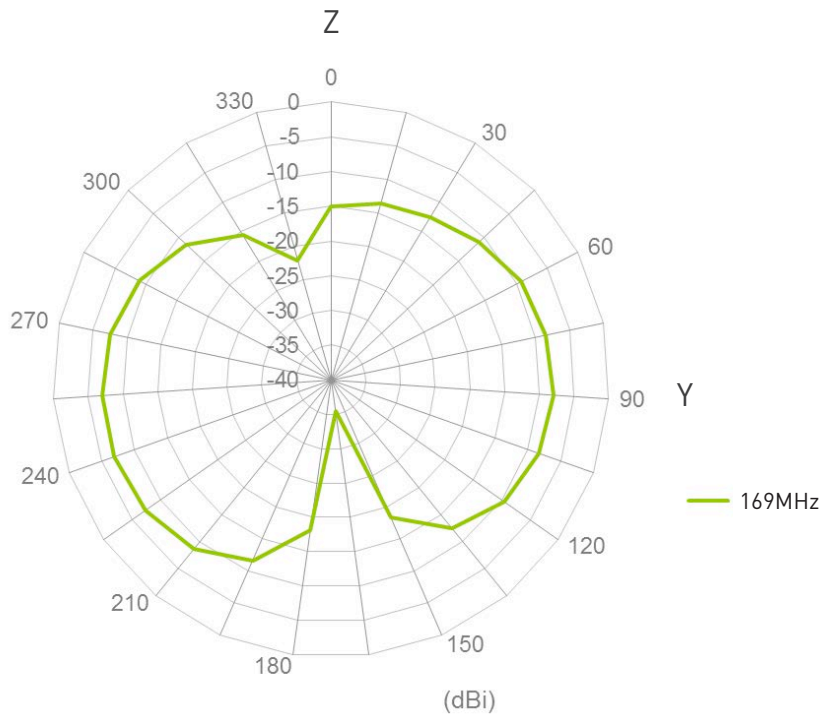

5. Antenna Radiation Pattern

CAD.B.69

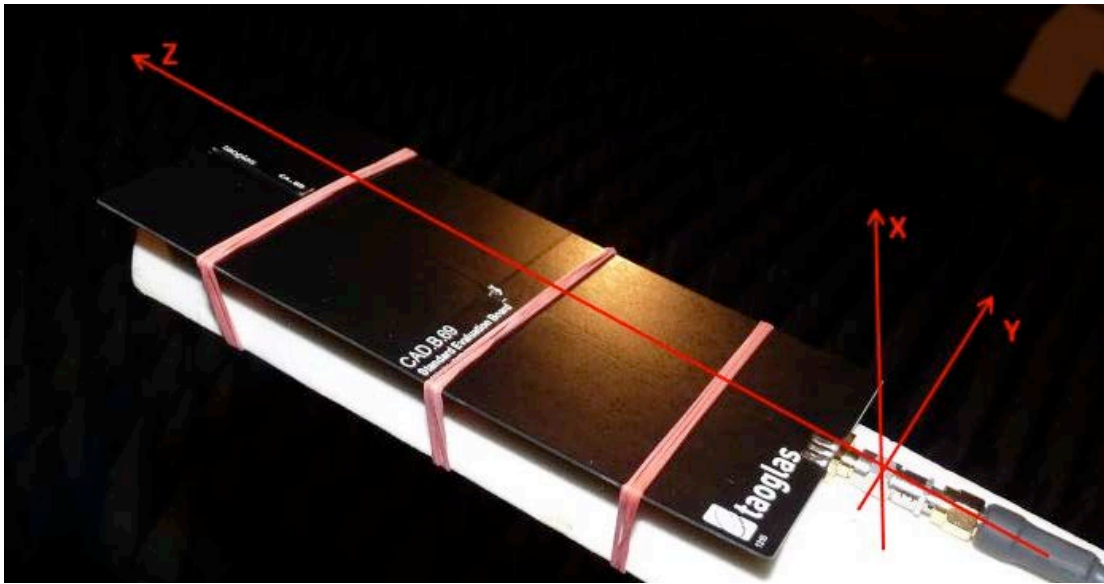

XY Plane

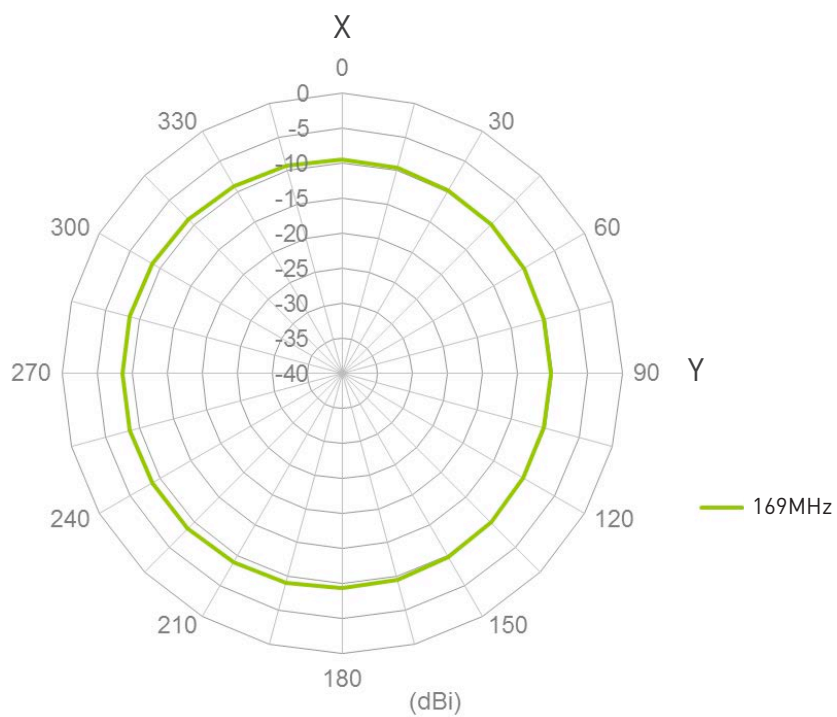

5. Antenna Radiation Pattern

XZ Plane

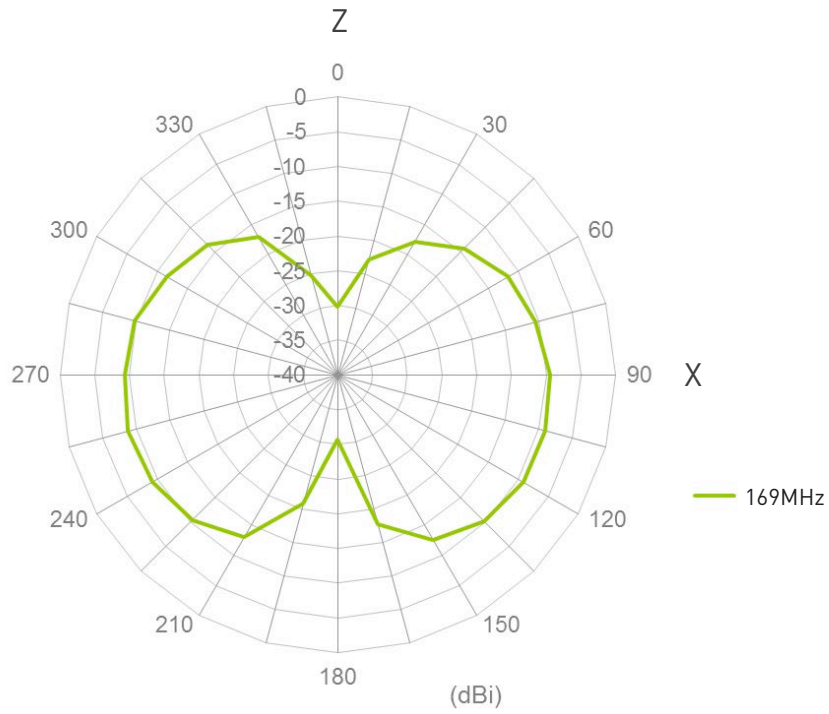

YZ Plane

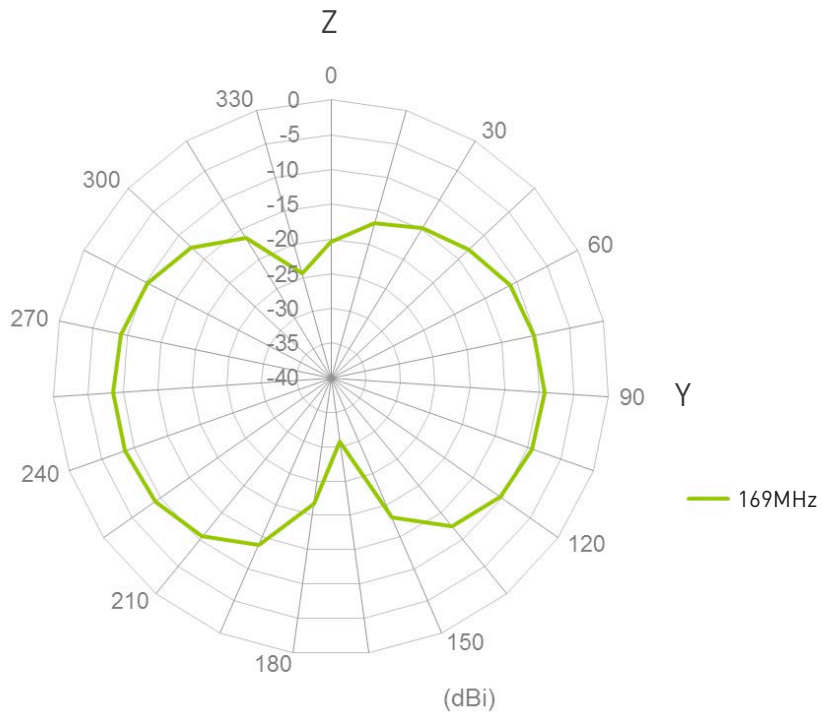

6. Mechanical Drawing

Antenna Main Body

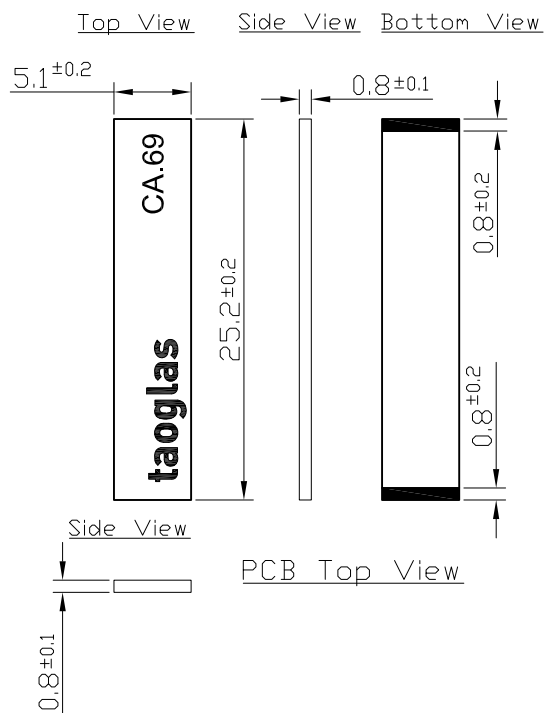

6. Mechanical Drawing

CAD.A.69 Application

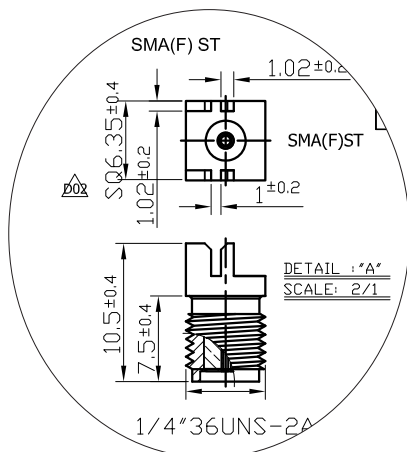
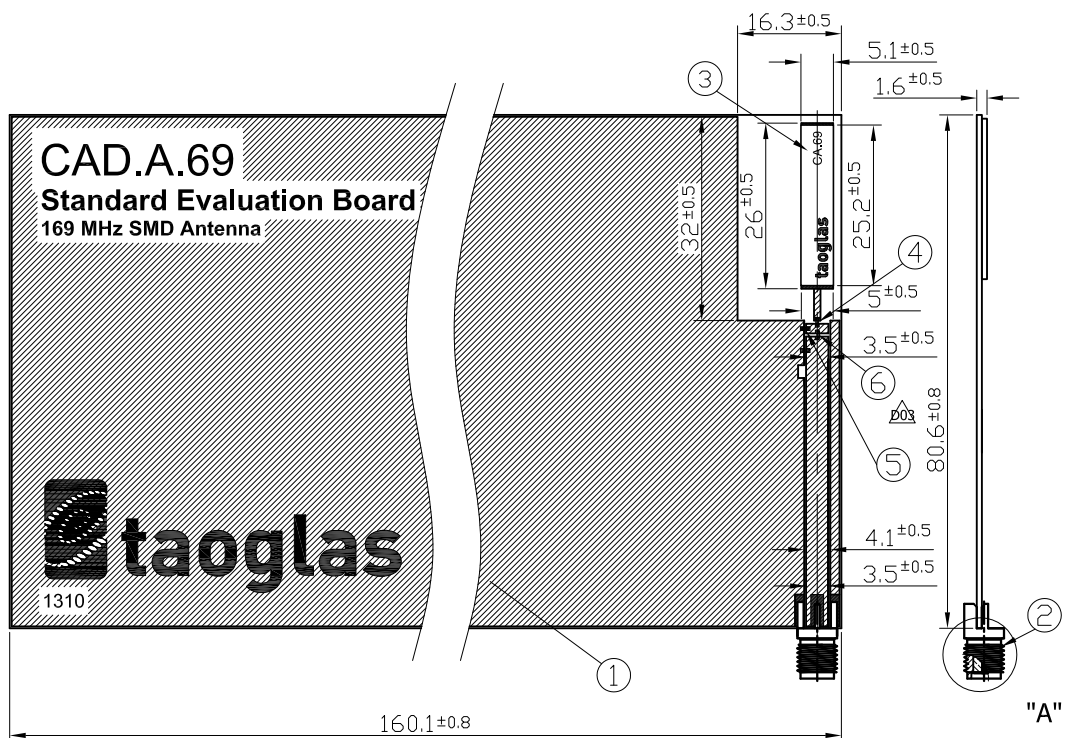

	Name	Material	Finish	QTY
1	CAD.A.69 EVB PCB	FR4 0.8t	Black	1
2	SMA(F) ST	Brass	Gold	1
3	CA.69 Antenna	FR4 0.8t	Black	1
4	Inductor (L=300nH) 0402	Ceramic	N/A	1
5	Capacitor (C=1pF) 0402	Ceramic	N/A	1
6	Inductor (L=270nH) 0402	Ceramic	N/A	1

6. Mechanical Drawing

CAD.B.69 Application

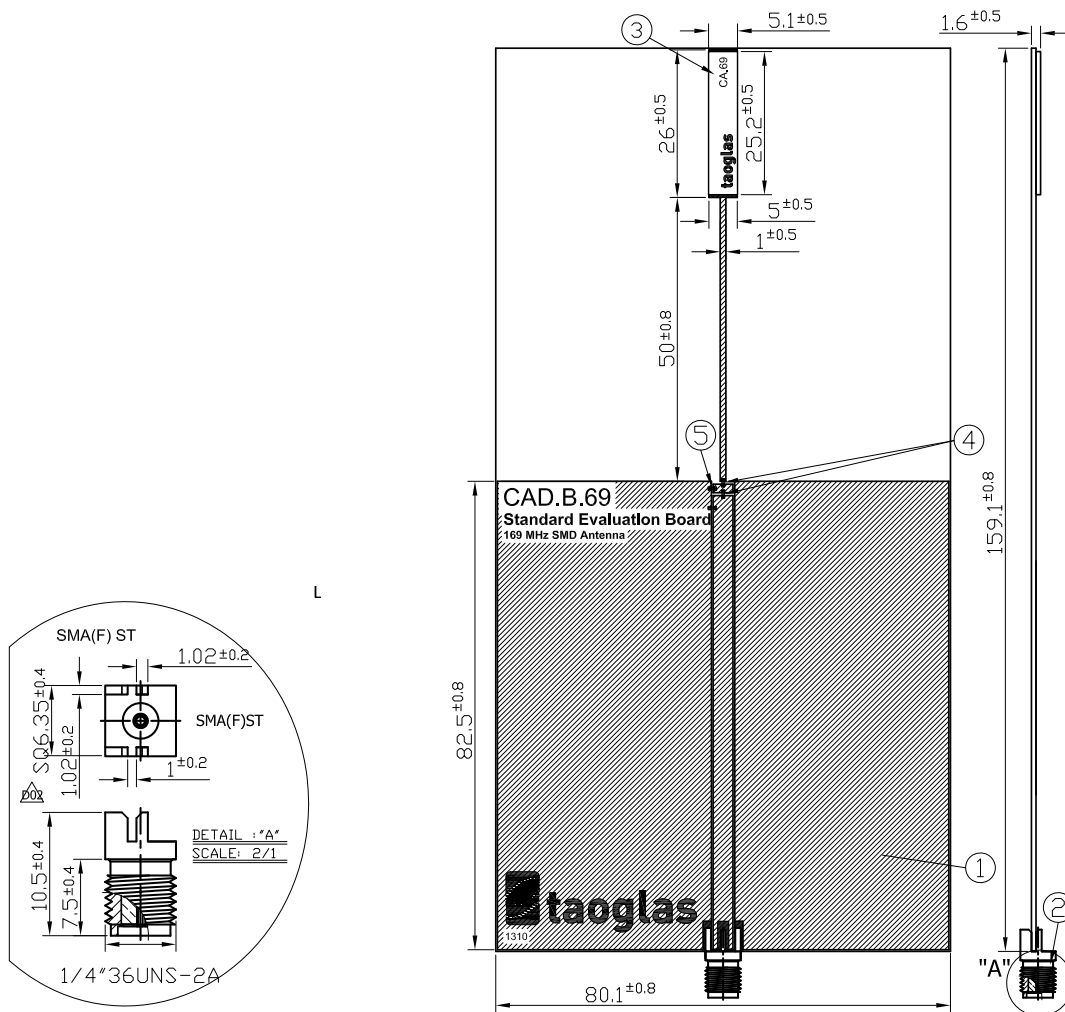

	Name	Material	Finish	QTY
1	CAD.A.69 EVB PCB	FR4 0.8t	Black	1
2	SMA(F) ST	Brass	Gold	1
3	CA.69 Antenna	FR4 0.8t	Black	1
4	Inductor (L=220nH) 0402	Ceramic	N/A	2
5	Capacitor (C=1pF) 0402	Ceramic	N/A	1

7. Layout Guide

Solder Land Pattern

FR4 0.8t PCB Foot Print

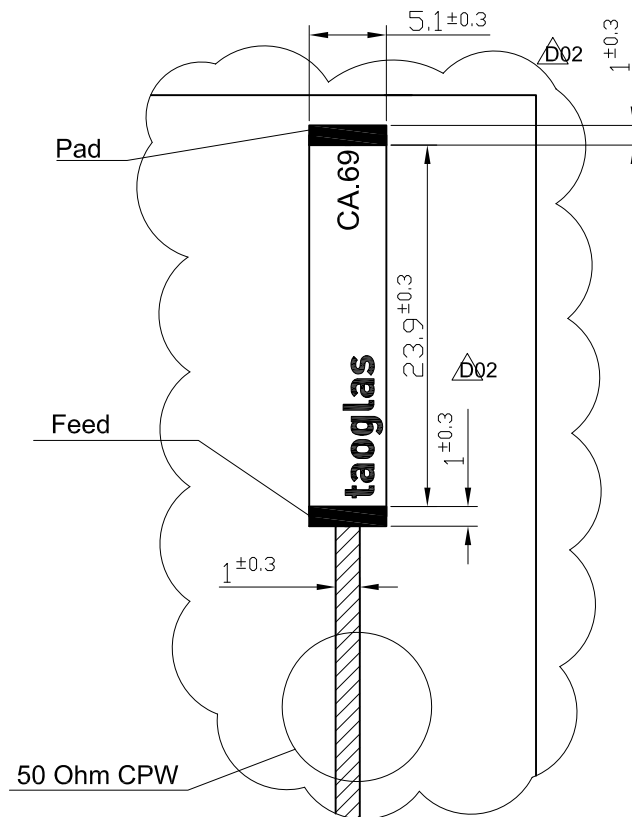

Matching Circuit:

CAD.A.69

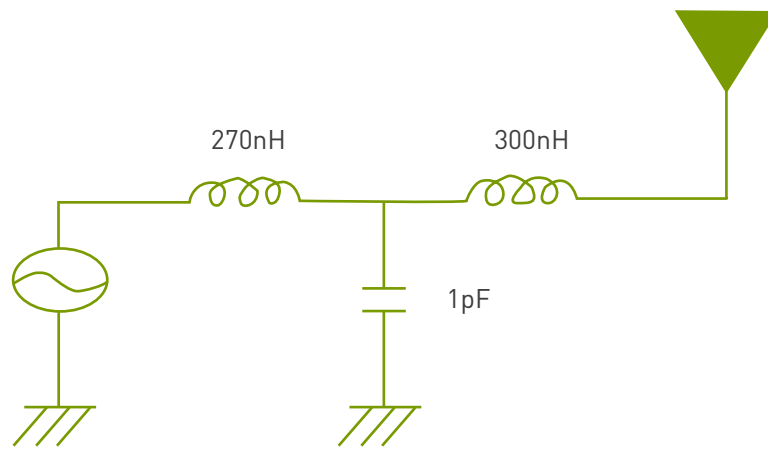

CAD.B.69

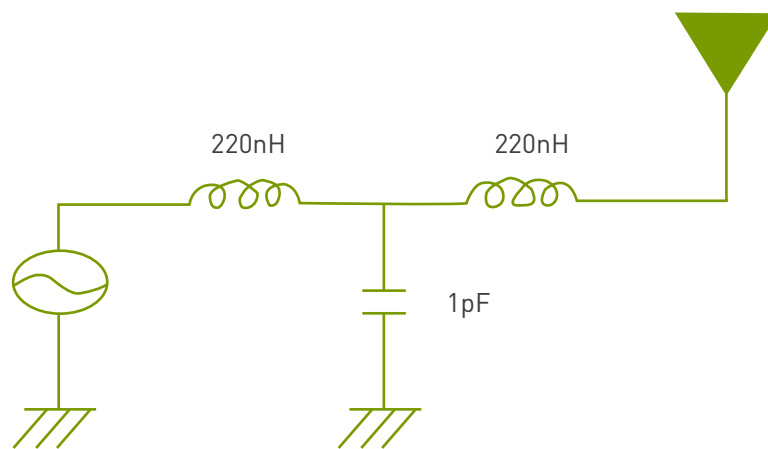

8. Soldering Conditions

Typical Soldering profile for lead-free process:

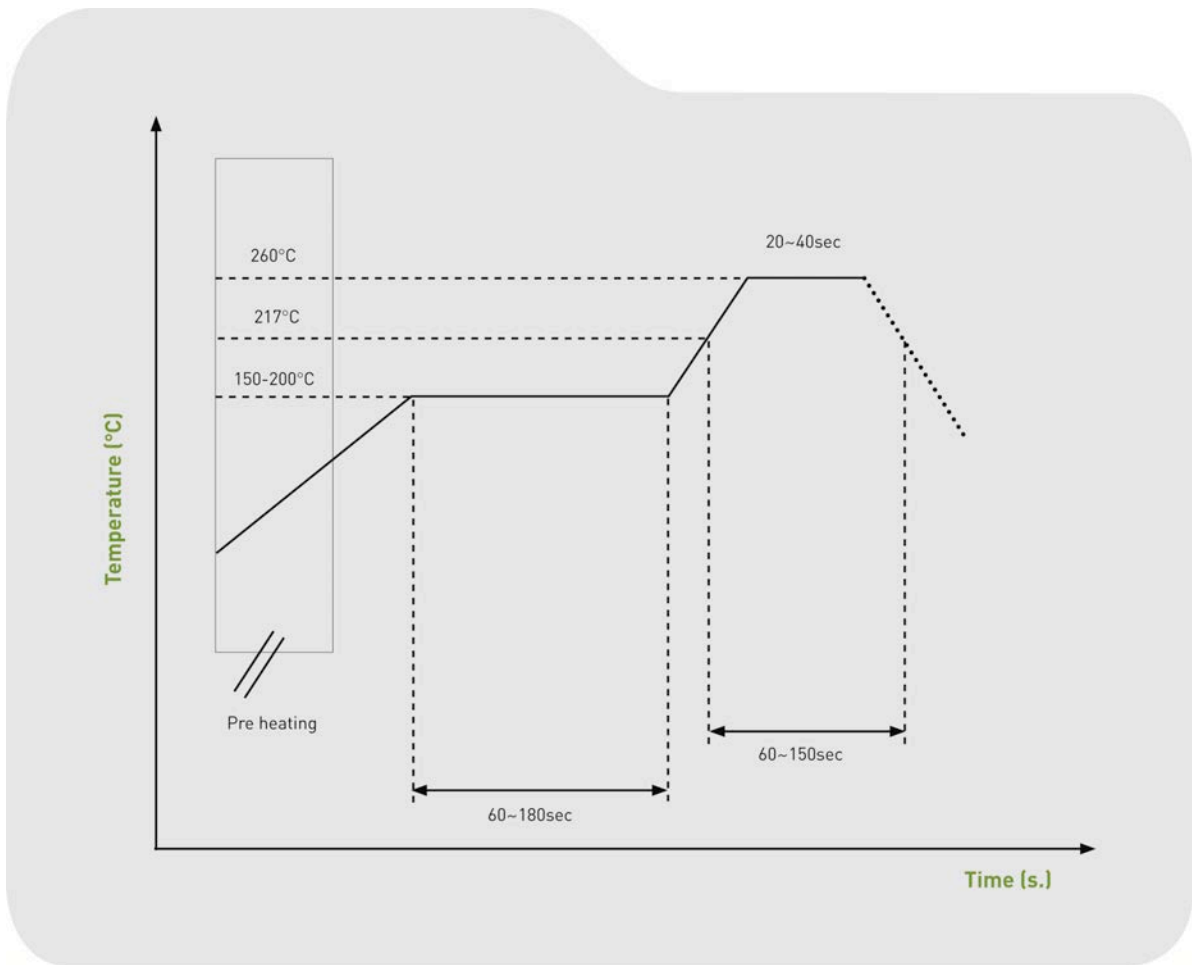

9. Packing

Quantity: 4000pcs / Reel

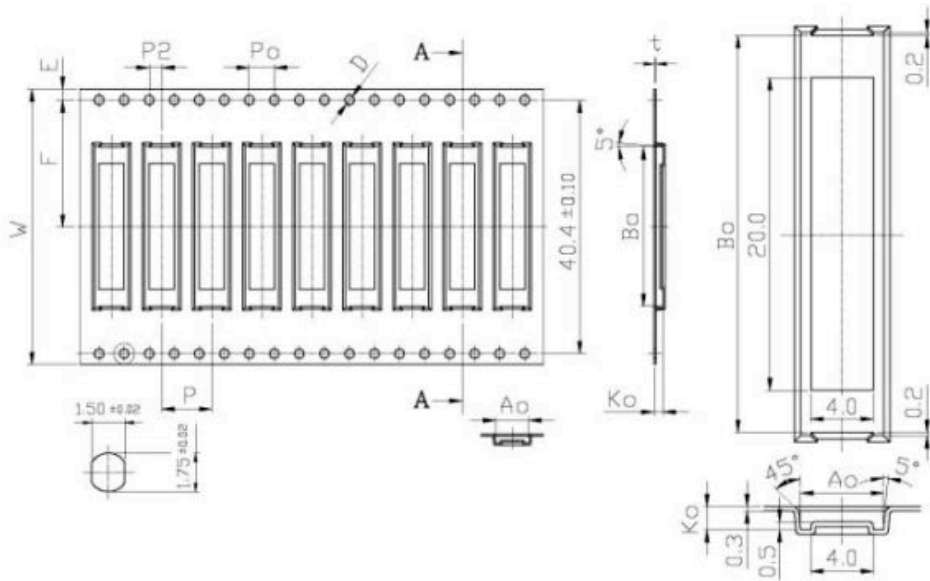

Tape

Dimensions (unit: mm)

Feature	Specification	Tolerance
W	44.00	± 0.30
P	8.00	± 0.10
E	1.75	± 0.10
F	20.20	± 0.10
P2	2.00	± 0.10
D	1.50	$+0.10 / -0.00$
D1	2.00	± 0.10
Po	4.00	± 0.10
10Po	40.00	± 0.20

Pocket Dimensions (unit: mm)

Feature	Specification	Tolerance
Ao	5.3	$+0.10$
Bo	25.45	-0.10
Ko	1.50	± 0.05
t	0.30	± 0.05

1. Cumulative tolerance of 10 pocket hole pitch: ± 0.20 mm
2. Carrier camber not to exceed 1mm in 250mm
3. Ao and Bo measured on a plane above the inside bottom of the pocket
4. Ko measured from a plane on the inside bottom of the pocket to the top surface of the carrier
5. All dimensions meet EIA-481-B requirements
6. Material – Clear non Anti-Static Polystyrene, Black Conductive Polystyrene