

## Specification

- Part No. : **TG.10.0113**
- Product Name : **Triton** - 4G/3G/2G Terminal Antenna for Cellular Gateways and Routers with Assisted GPS Hinged SMA(M)
- Features : LTE / GSM / CDMA /GPS/ DCS /PCS / WCDMA / UMTS / HSPA / GPRS / EDGE /IMT  
698MHz to 960MHz, 1710MHz to 2690Mhz  
Dipole Terminal Antenna  
Hinged SMA(M) Connector  
Dimensions: Length 168\*18\*13mm, Ø13mm  
**RoHS Compliant**



## **1. Introduction**

The TG.10 Triton dipole Antenna designed primarily for use with 3G and 4G Cellular Gateways and Routers, with assisted GPS. It does not require a ground-plane to connect to. It has a quality robust PC+ABS housing. The antenna has a SMA(M) connector. It can be used straight or hinged 90 degrees. The antenna has a wide-band high efficiency response on nearly all 4G/3G/2G frequency bands worldwide, and can also be used for other cellular and wireless applications such as GSM, and 2.4GHz Wi-Fi.

## 2. Specification

ELECTRICAL										
In free space										
Frequency (MHz)	703~803	824~894	880~960	1575.42	1710 ~1880	1850 ~1990	1920 ~2170	2305 ~2360	2490 ~2690	3400 ~3600
<b>Efficiency (%)</b>										
straight	41.82	33.71	26.83	26.17	41.01	35.76	39.76		46.48	
bent	48.78	45.62	40.51	26.82	49.05	43.56	47.78		55.37	
<b>Average Gain(dBi)</b>										
straight	-3.80	-4.74	-5.73	-5.82	-3.92	-4.48	-4.03		-3.44	
bent	-3.12	-3.41	-3.93	-5.71	-3.14	-3.62	-3.22		-2.63	
<b>Peak Gain(dBi)</b>										
straight	0.34	0.03	-0.48	-1.85	0.67	-0.07	0.23		2.04	
bent	-0.21	0.35	0.22	-2.00	1.00	0.65	1.30		3.45	
With 15cm X 9cm ground										
Frequency (MHz)	703~803	824~894	880~960	1575.42	1710 ~1880	1850 ~1990	1920 ~2170	2305 ~2360	2490 ~2690	3400 ~3600
<b>Efficiency (%)</b>										
straight	71.68	49.29	43.13	20.87	57.84	67.45	74.31		66.25	
bent	74.12	61.90	51.94	23.16	53.64	67.19	73.14		68.20	
<b>Average Gain(dBi)</b>										
straight	-1.45	-3.08	-3.66	-6.80	-2.38	-1.74	-1.30		-1.84	
bent	-1.30	-2.09	-2.86	-6.35	-2.71	-1.76	-1.36		-1.70	
<b>Peak Gain(dBi)</b>										
straight	2.85	1.20	0.19	-2.47	2.34	3.57	4.22		3.95	
bent	1.43	0.79	-0.13	-1.44	2.08	2.69	2.96		4.44	
On 30cmX30cm ground plane edge										
Frequency (MHz)	703~803	824~894	880~960	1575.42	1710 ~1880	1850 ~1990	1920 ~2170	2305 ~2360	2490 ~2690	3400 ~3600
<b>Efficiency (%)</b>										
straight	57.56	41.53	42.09	18.06	75.91	71.83	68.52		57.08	
bent	57.30	48.37	42.12	20.37	72.62	71.93	70.21		58.98	
<b>Average Gain(dBi)</b>										
straight	-2.41	-3.82	-3.76	-7.43	-1.20	-1.44	-1.65		-2.50	
bent	-2.42	-3.19	-3.76	-6.90	-1.39	-1.43	-1.54		-2.36	
<b>Peak Gain(dBi)</b>										
straight	2.96	0.68	-0.01	-3.02	3.37	2.83	2.82		3.17	
bent	0.61	-0.78	-0.87	-2.61	3.49	4.63	4.76		3.12	

On 30cmX30cm ground plane center										
Frequency (MHz)	703~803	824~894	880~960	1575.42	1710 ~1880	1850 ~1990	1920 ~2170	2305 ~2360	2490 ~2690	3400 ~3600
<b>Efficiency (%)</b>										
straight	42.15	28.00	20.35	24.88	39.11	49.92	55.35		47.74	
bent	27.52	21.92	15.49	24.23	61.22	64.56	62.92		56.43	
<b>Average Gain(dBi)</b>										
straight	-3.76	-5.65	-6.92	-6.04	-4.09	-3.04	-2.58		-3.33	
bent	-5.63	-6.67	-8.12	-6.15	-2.14	-1.90	-2.02		-2.52	
<b>Peak Gain(dBi)</b>										
straight	-0.06	-0.66	-1.81	-2.50	0.98	2.01	2.33		2.07	
bent	-0.31	-2.93	-4.79	1.22	4.11	5.42	4.94		4.70	
Impedance		50Ω								
Polarization		Linear								
Radiation Pattern		Omni								
Input power		5 W								
MECHANICAL										
Dimensions	Length 168*18*13mm,Φ13mm									
Casing	PC+ABS									
Connector	Hinged SMA Male									
Weight	24g									
Recommended Torque for Mounting	0.9 N·m									
Max Torque for Mounting	1.176 N·m									
ENVIRONMENTAL										
Temperature Range	-40°C to 85°C									
Humidity	Non-condensing 65°C 95% RH									

\*All the bent testing are at 90 degrees bent.

LTE BANDS			
Band Number	LTE / LTE-Advanced / WCDMA / HSPA / HSPA+ / TD-SCDMA		
	Uplink	Downlink	Covered
1	UL: 1920 to 1980	DL: 2110 to 2170	✓
2	UL: 1850 to 1910	DL: 1930 to 1990	✓
3	UL: 1710 to 1785	DL: 1805 to 1880	✓
4	UL: 1710 to 1755	DL: 2110 to 2155	✓
5	UL: 824 to 849	DL: 869 to 894	✓
7	UL: 2500 to 2570	DL: 2620 to 2690	✓
8	UL: 880 to 915	DL: 925 to 960	✓
9	UL: 1749.9 to 1784.9	DL: 1844.9 to 1879.9	✓
11	UL: 1427.9 to 1447.9	DL: 1475.9 to 1495.9	✗
12	UL: 699 to 716	DL: 729 to 746	✓
13	UL: 777 to 787	DL: 746 to 756	✓
14	UL: 788 to 798	DL: 758 to 768	✓
17	UL: 704 to 716	DL: 734 to 746 (LTE only)	✓
18	UL: 815 to 830	DL: 860 to 875 (LET only)	✓
19	UL: 830 to 845	DL: 875 to 890	✓
20	UL: 832 to 862	DL: 791 to 821	✓
21	UL: 1447.9 to 1462.9	DL: 1495.9 to 1510.9	✗
22	UL: 3410 to 3490	DL: 3510 to 3590	✗
23	UL: 2000 to 2020	DL: 2180 to 2200 (LTE only)	✓
24	UL: 1625.5 to 1660.5	DL: 1525 to 1559 (LTE only)	✗
25	UL: 1850 to 1915	DL: 1930 to 1995	✓
26	UL: 814 to 849	DL: 859 to 894	✓
27	UL: 807 to 824	DL: 852 to 869 (LTE only)	✓
28	UL: 703 to 748	DL: 758 to 803 (LTE only)	✓
29	UL: -	DL: 717 to 728 (LTE only)	✓
30	UL: 2305 to 2315	DL: 2350 to 2360 (LTE only)	✓
31	UL: 452.5 to 457.5	DL: 462.5 to 467.5 (LTE only)	✗
32	UL: -	DL: 1452 - 1496	✗
35		1850 to 1910	✓
38		2570 to 2620	✓
39		1880 to 1920	✓
40		2300 to 2400	✓
41		2496 to 2690	✓
42		3400 to 3600	✗
43		3600 to 3800	✗

\*Covered bands represent an efficiency greater than 20%

### 3. Antenna Characteristics

#### 3.1. Testing Setup

In free space



Antenna straight



Antenna bent

On 15 X 9cm ground plane

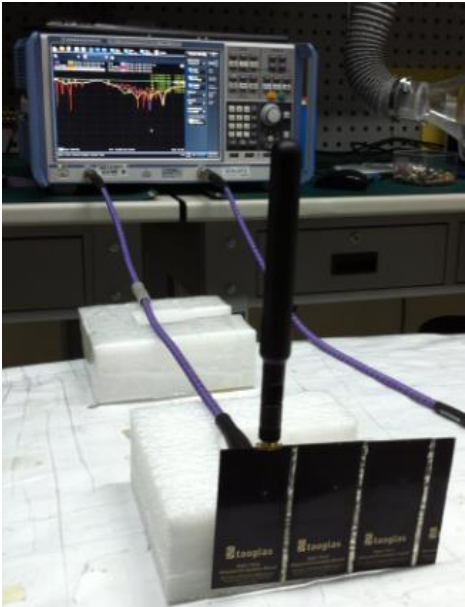

Antenna straight

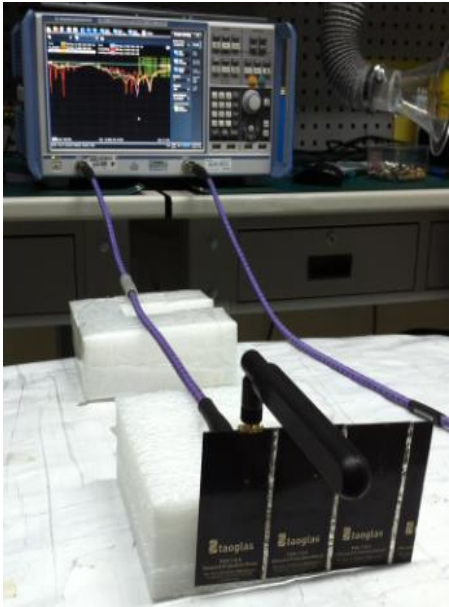

Antenna bent

On 30cm X 30cm ground plane edge



Antenna straight



Antenna bent

On 30cm X 30cm ground plane center



Antenna straight

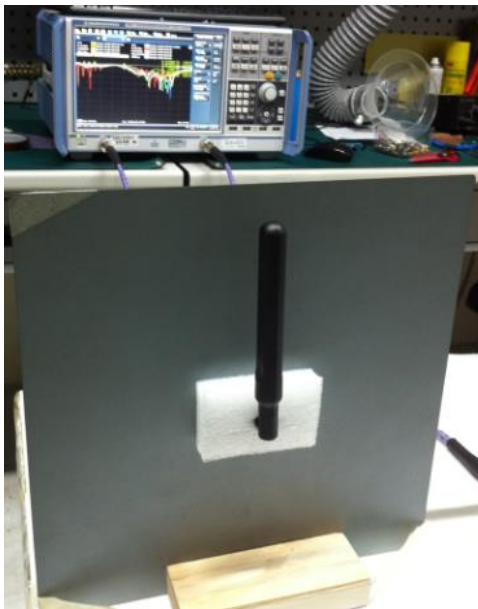

Antenna bent





## 3.2. Return Loss

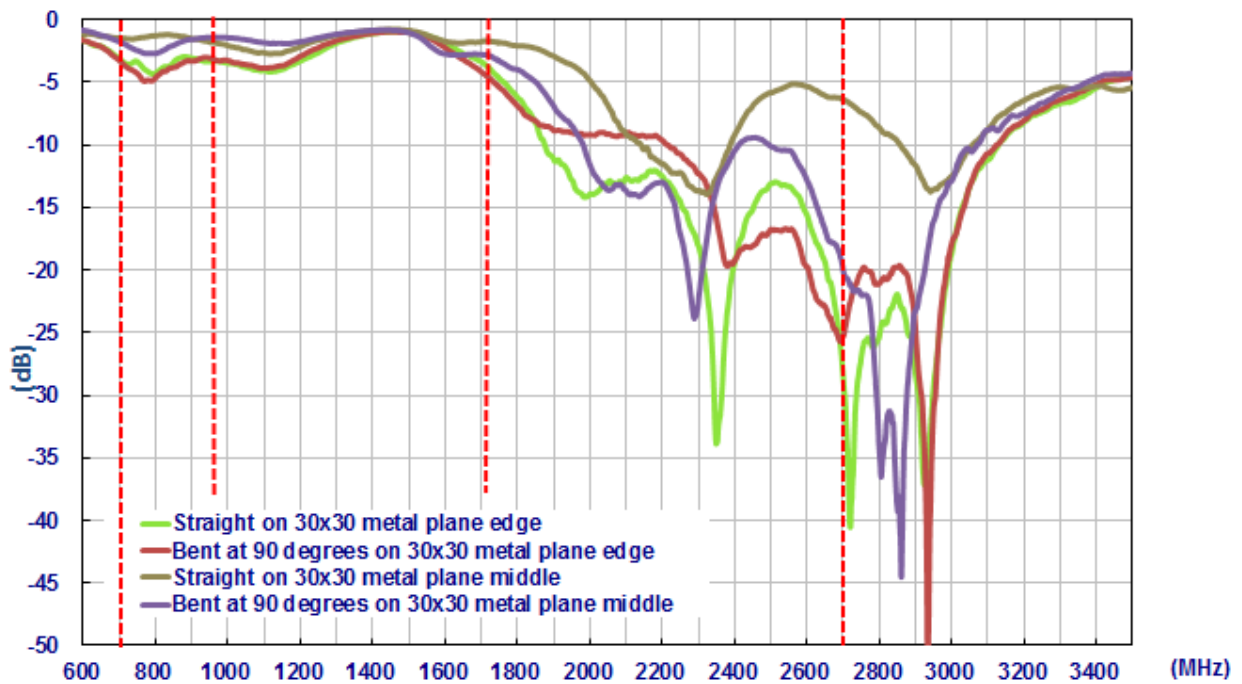
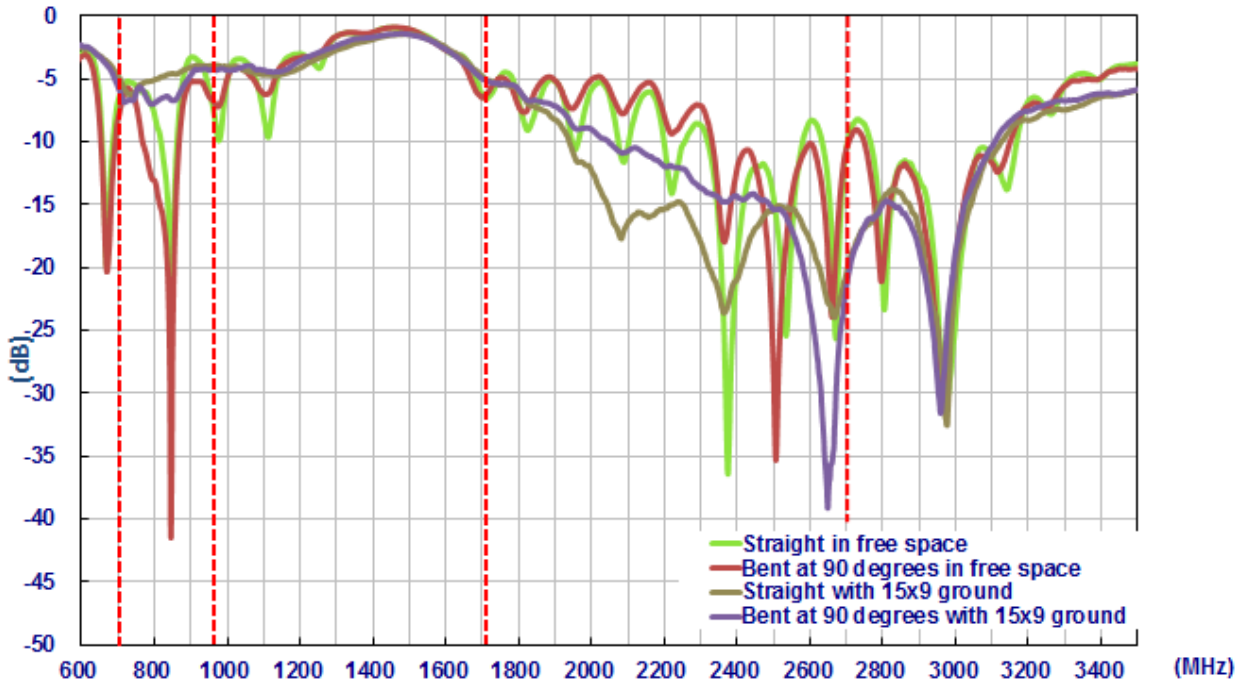



**3.3. Peak Gain**

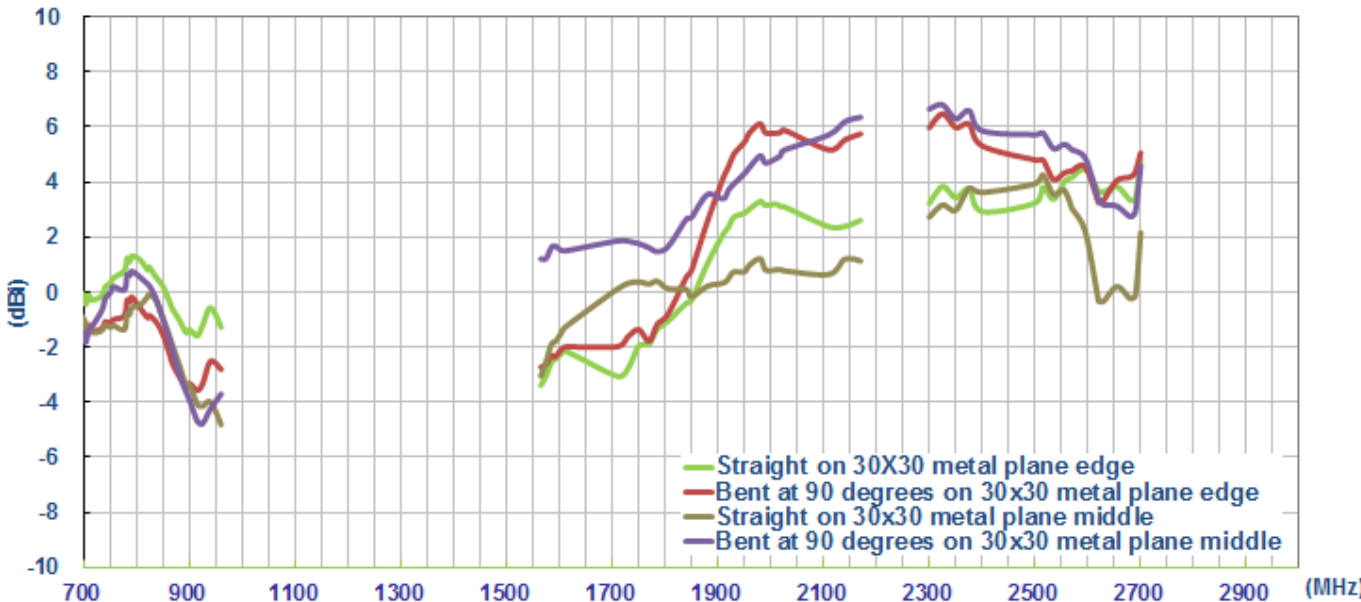
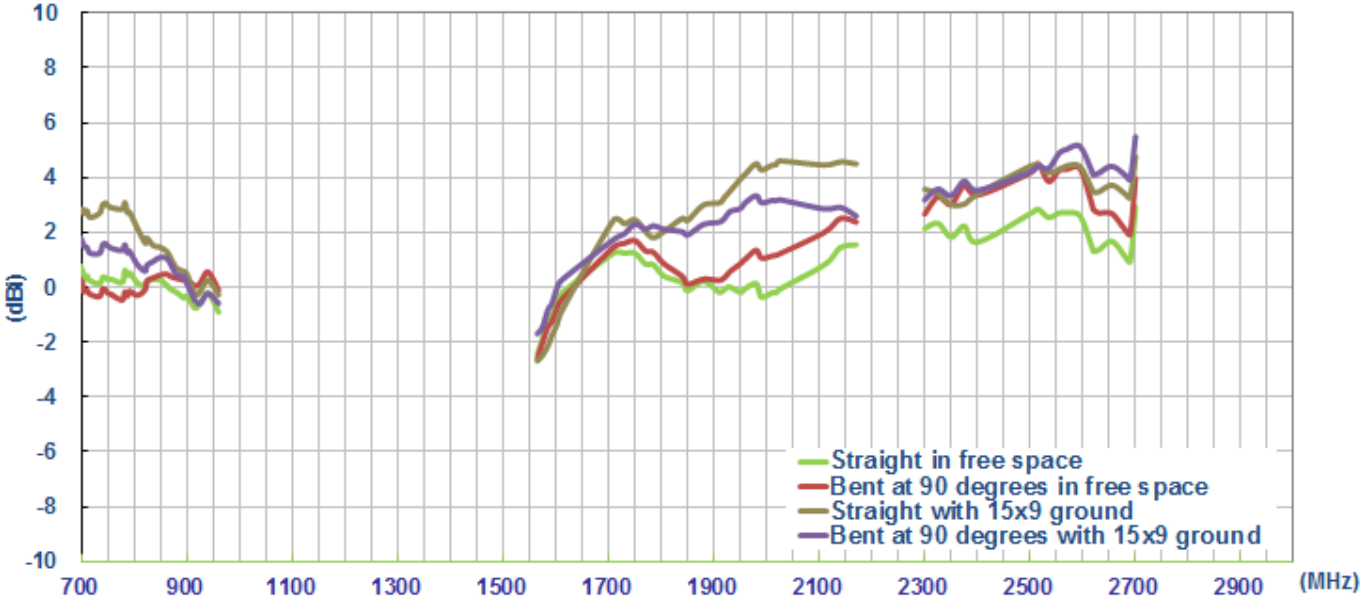

**3.4. VSWR**

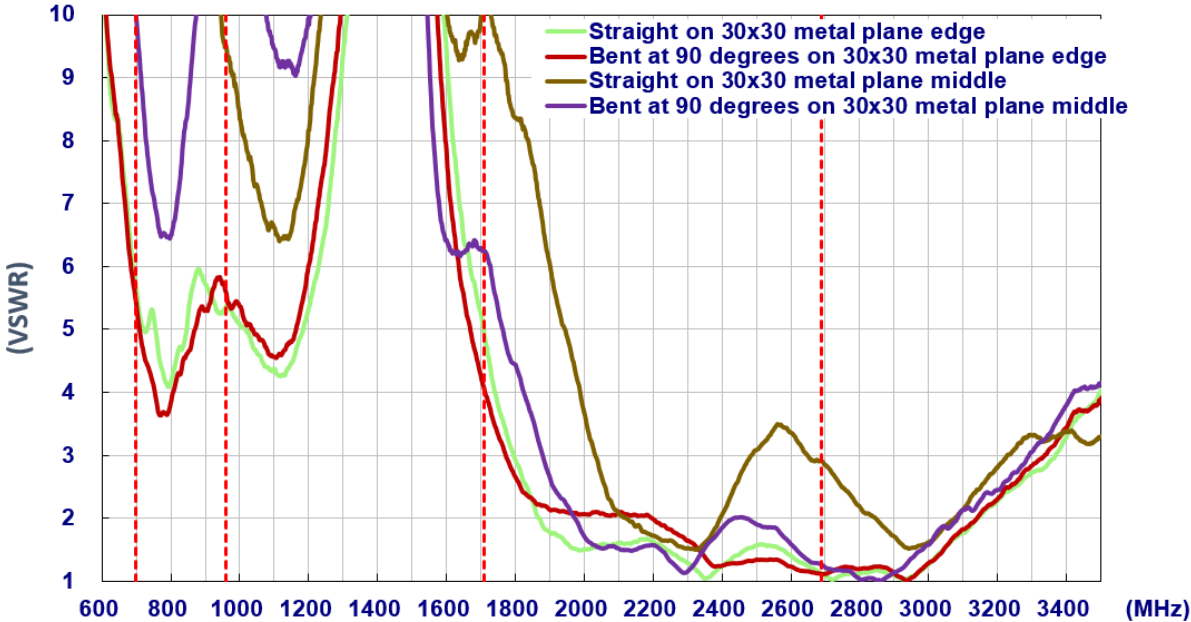
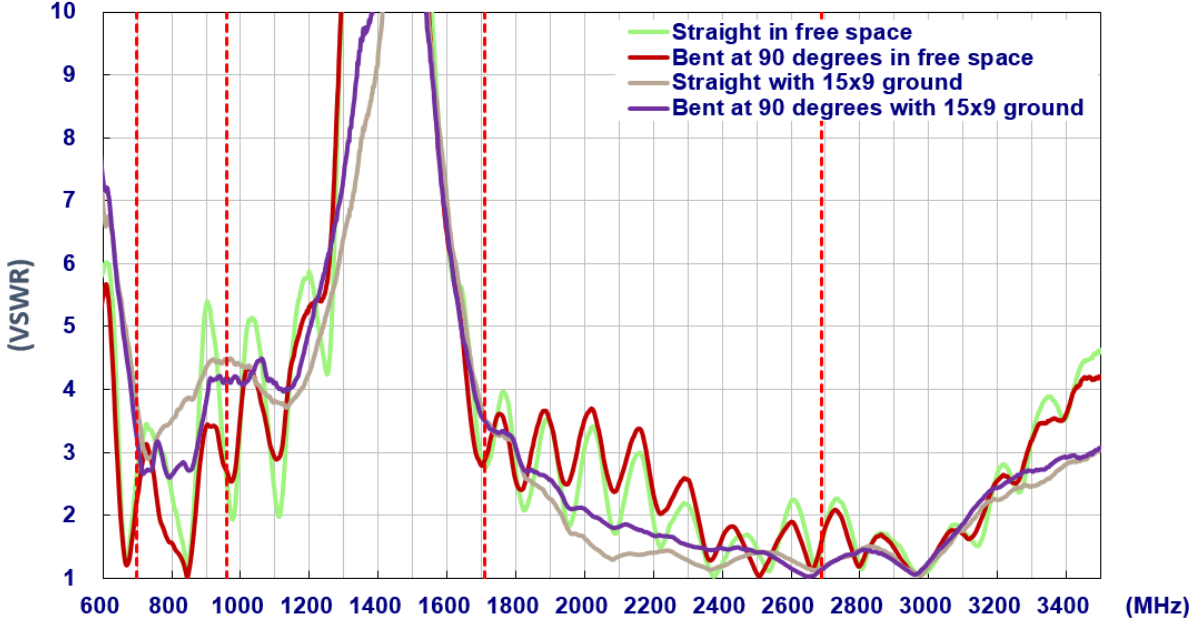



## 3.5. Efficiency

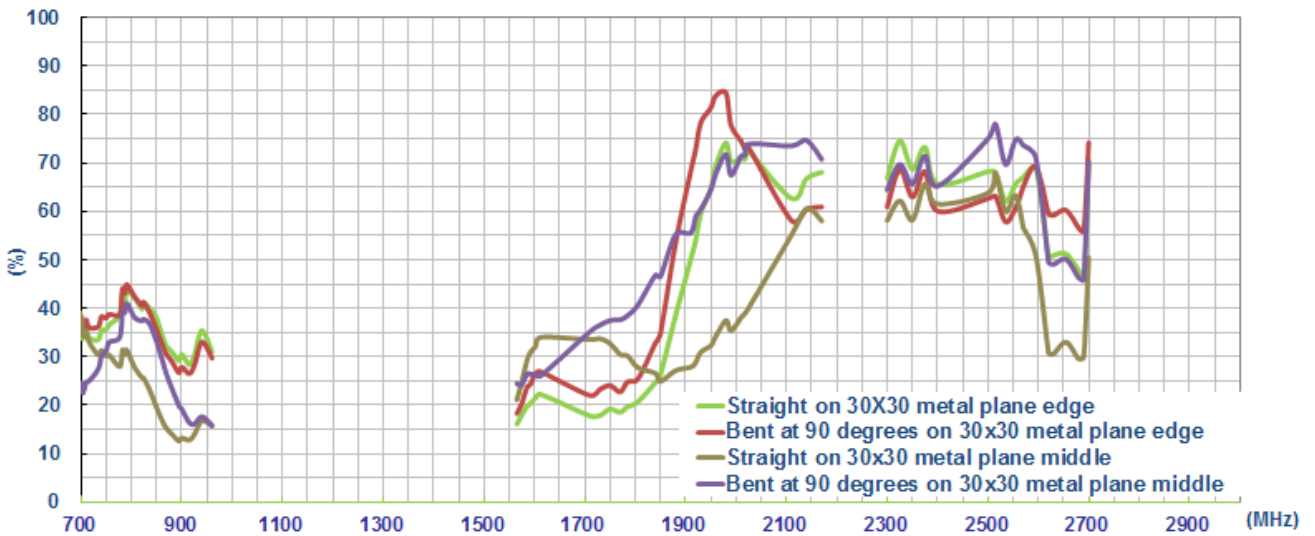
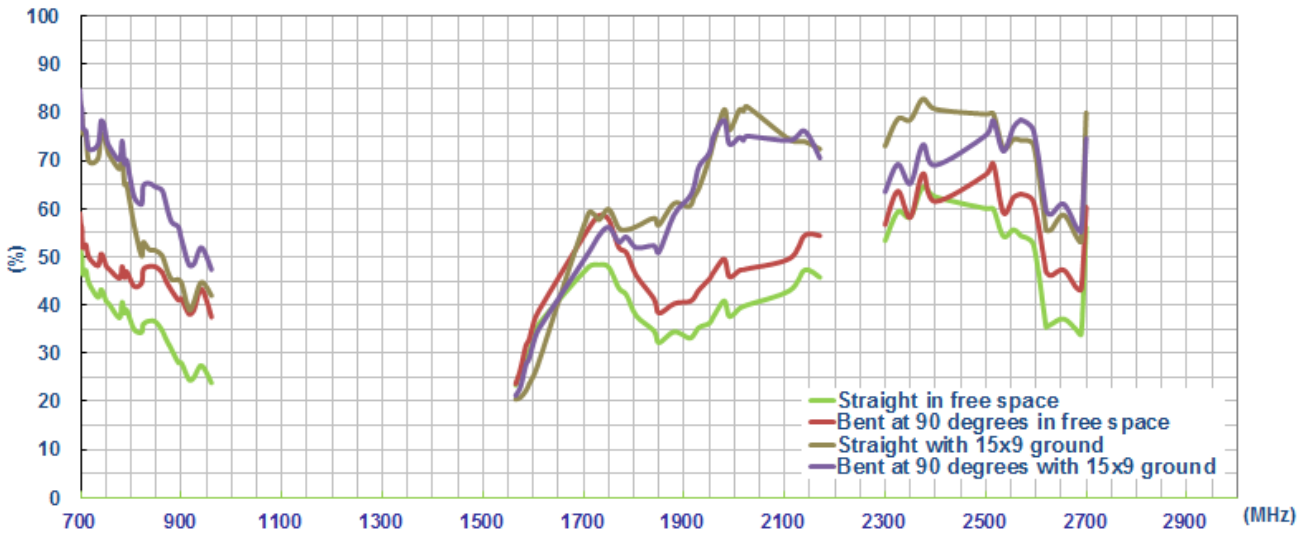



## 3.6. Average Gain

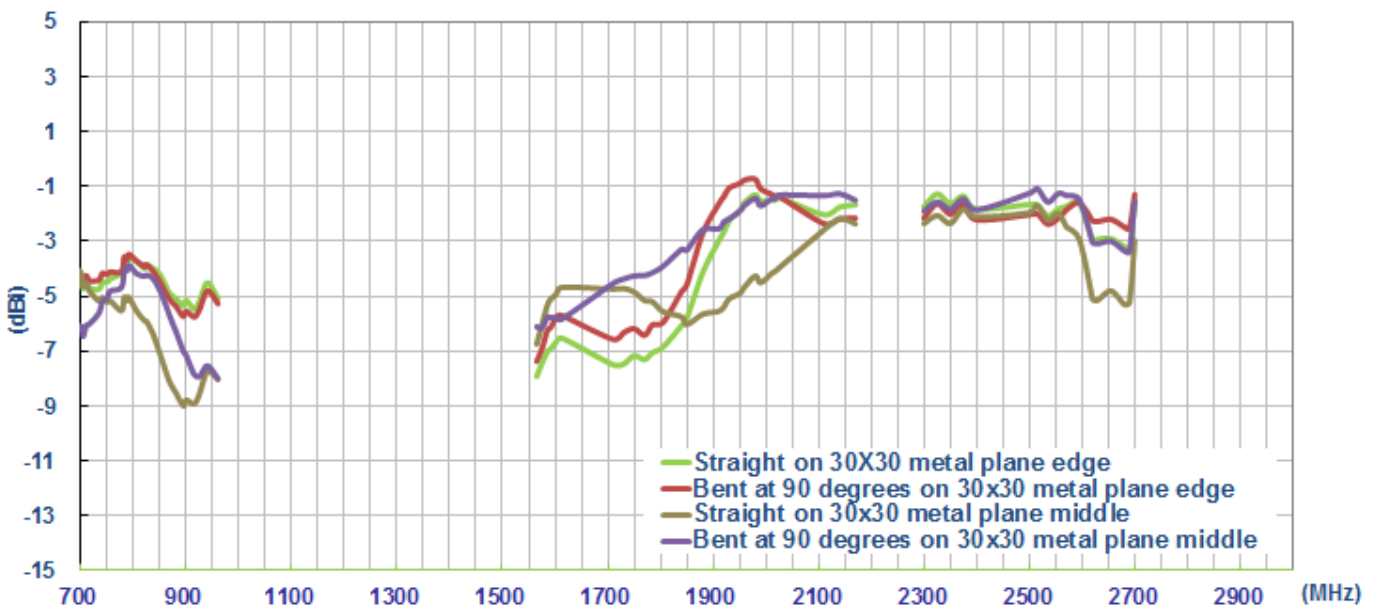
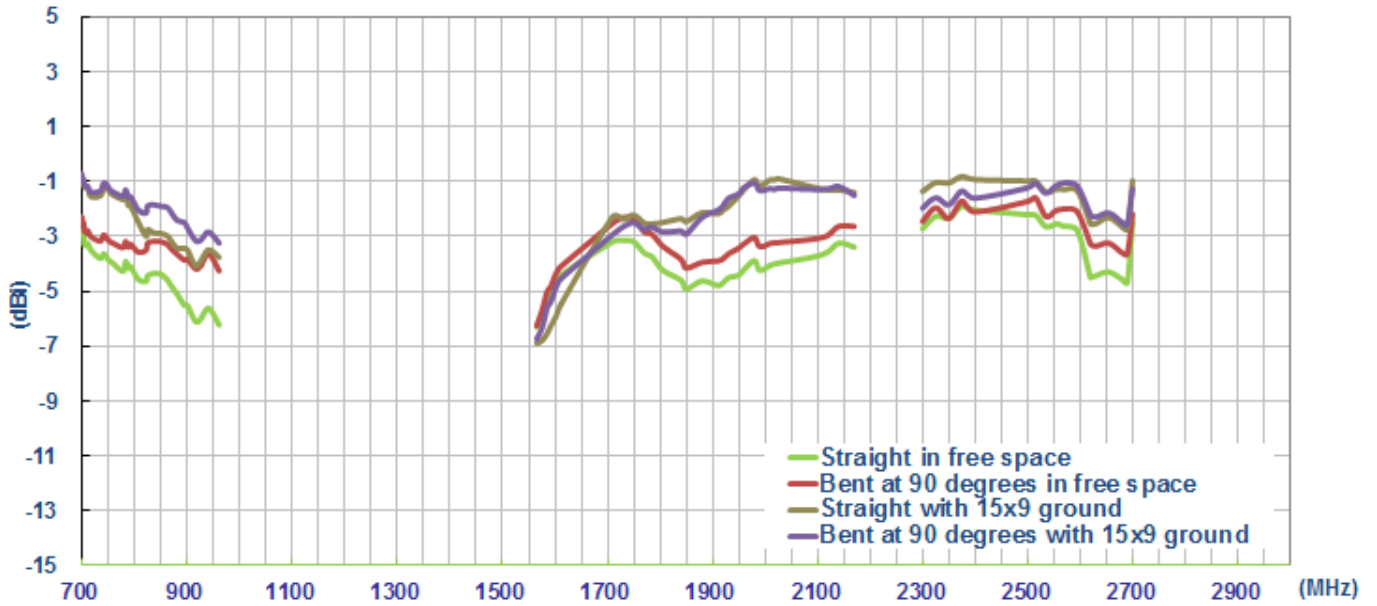

## 4. Antenna Radiation Patterns

### 4.1. Antenna Setup – Straight In Free Space

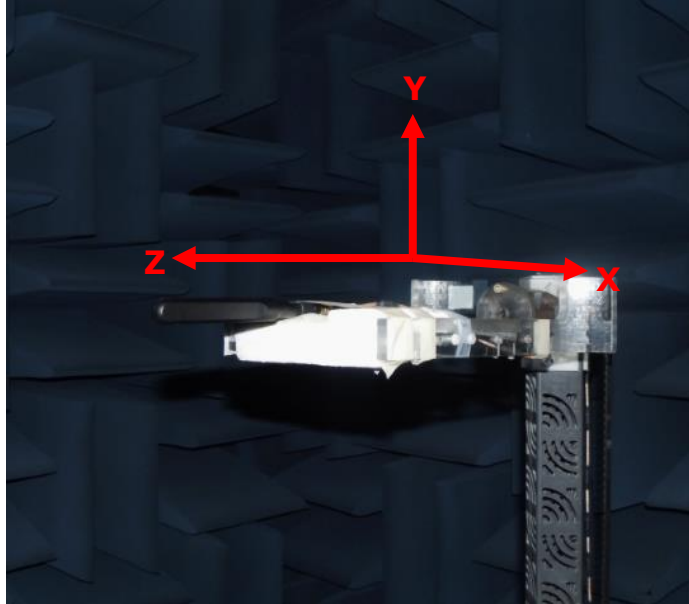

Antenna straight in free space



## 4.2. Antenna Radiation Patterns

XY Plane

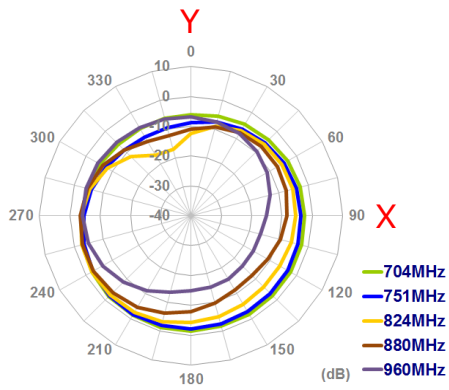

XZ Plane

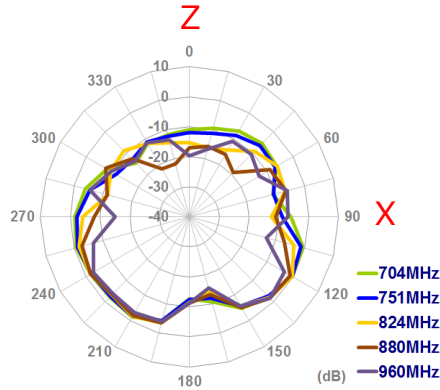

YZ Plane

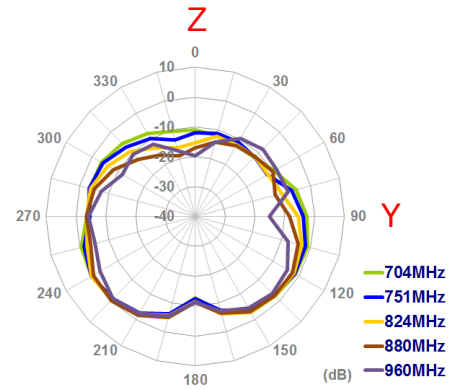

Y

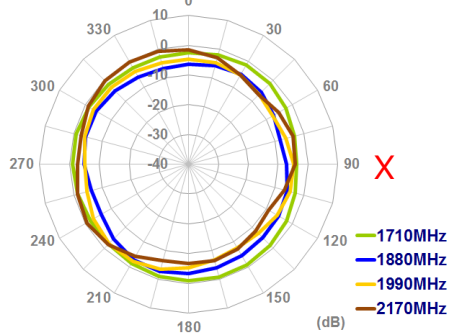

Z

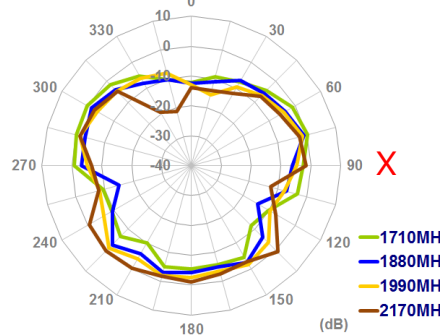

Z

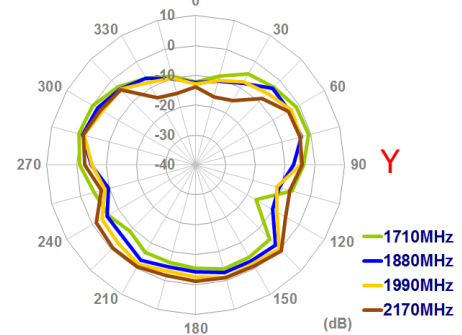

Y

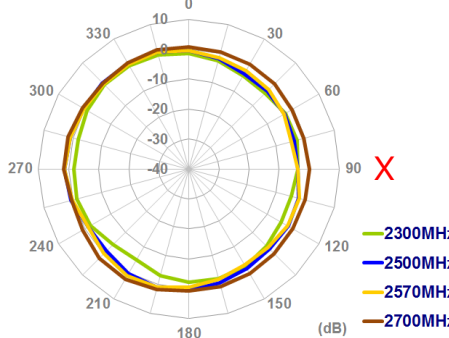

Z

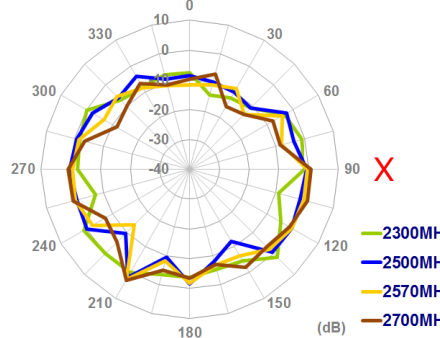

Z

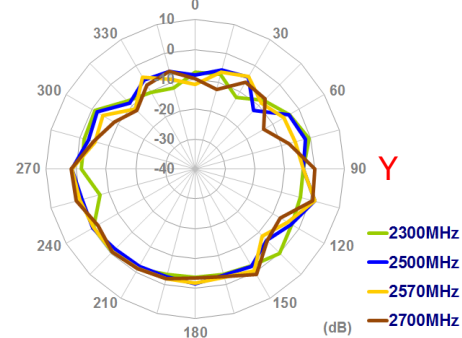

### 4.3. Antenna Setup – Bent At 90 Degrees In Free Space

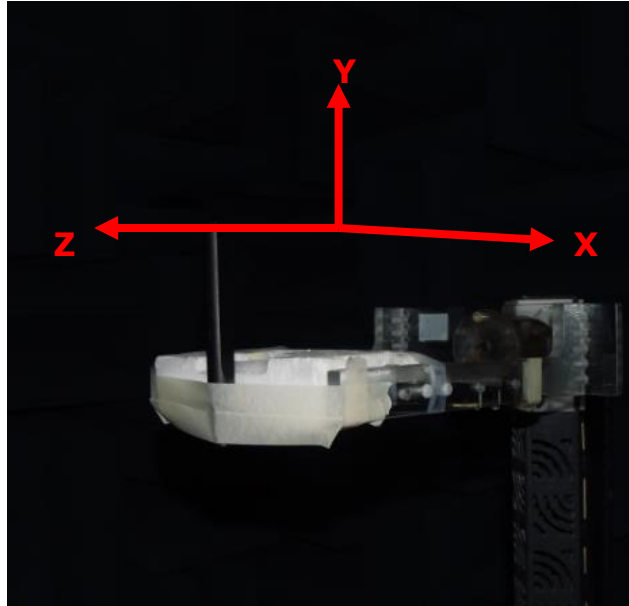

Antenna bent 90 degrees in free space



### 4.4. Antenna Radiation Patterns

XY Plane

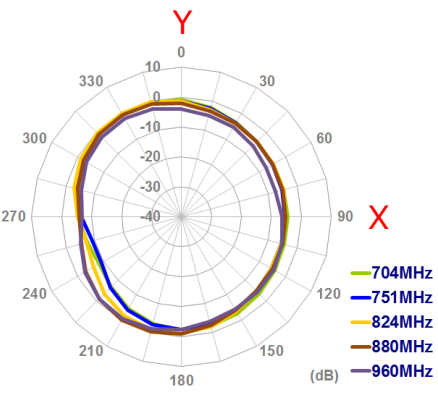

XZ Plane

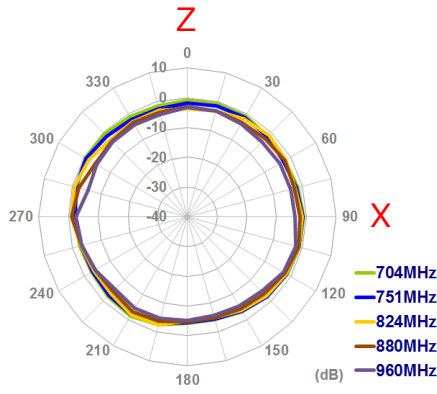

YZ Plane

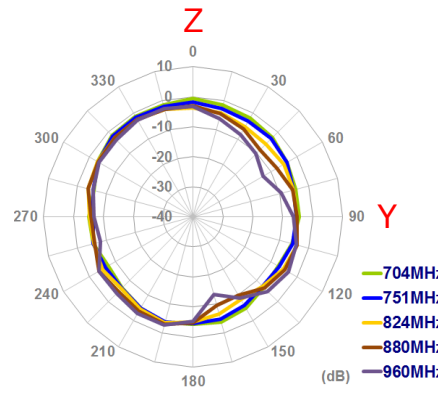

XY Plane

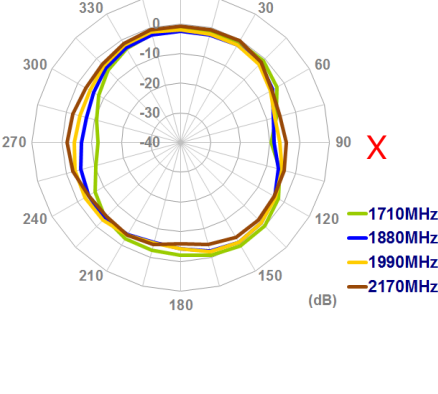

XZ Plane

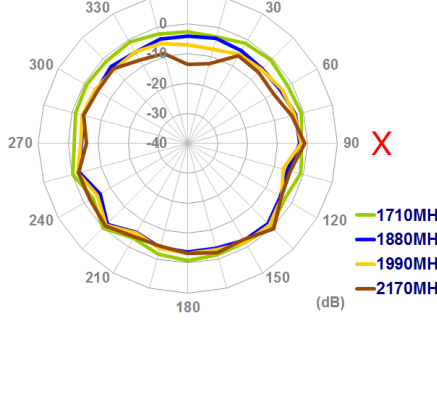

YZ Plane

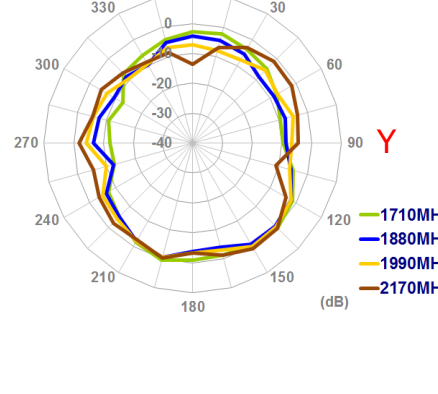

XY Plane

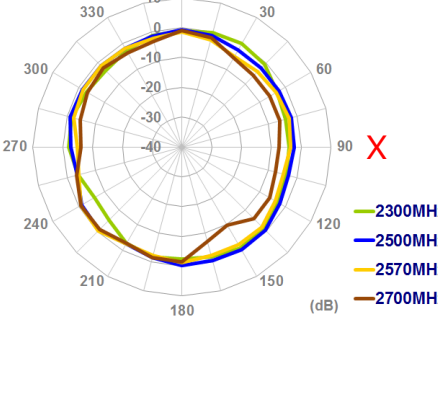

XZ Plane

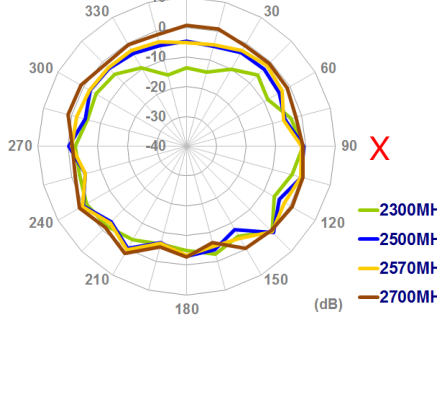

YZ Plane

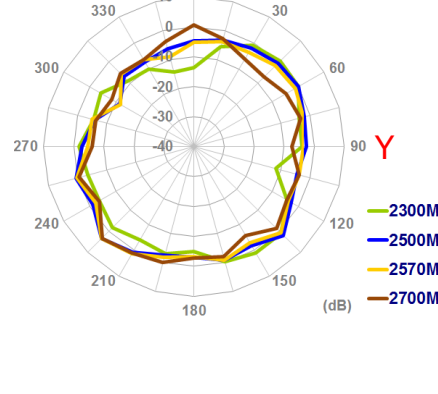

#### 4.5. Antenna Setup – Straight With 15cmX9cm Ground Plane

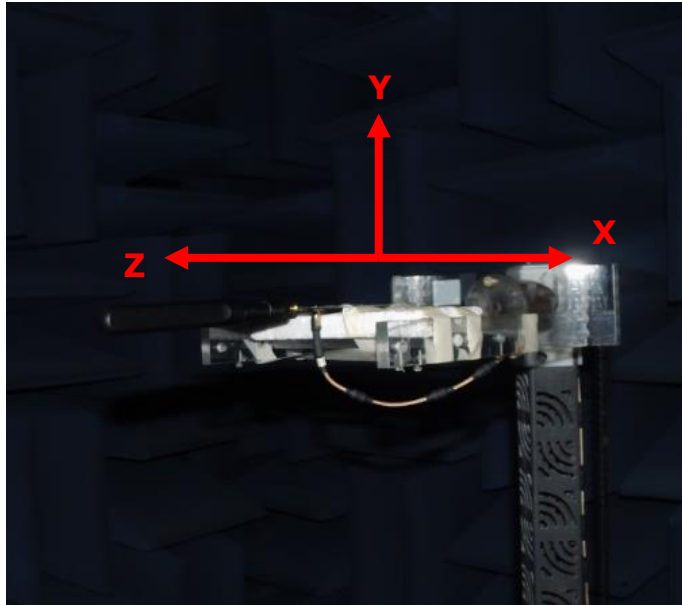

Antenna Straight with 15cm X 9cm ground plane

**4.6. Antenna Radiation Patterns**

XY Plane

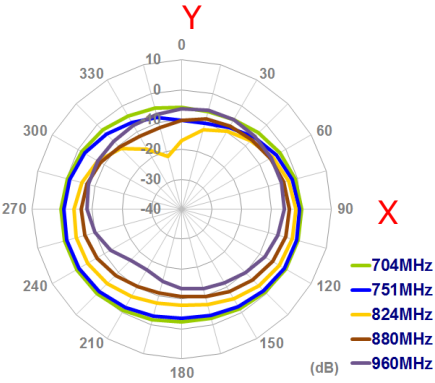

XZ Plane

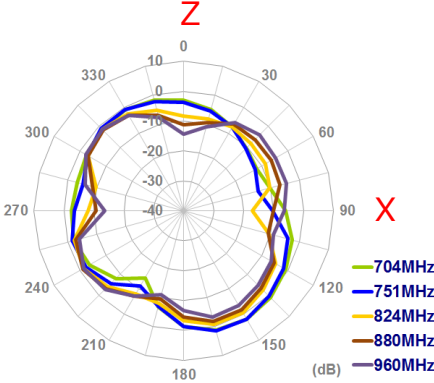

YZ Plane

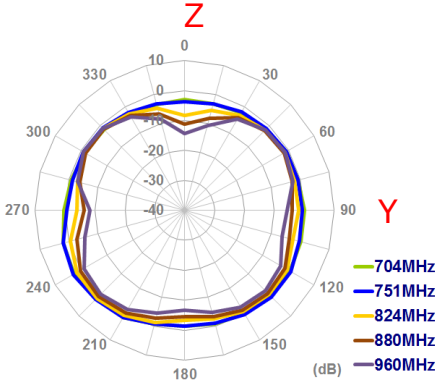

XY Plane

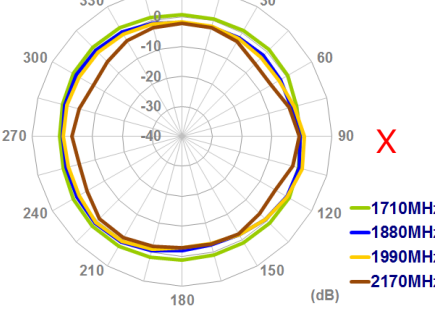

XZ Plane

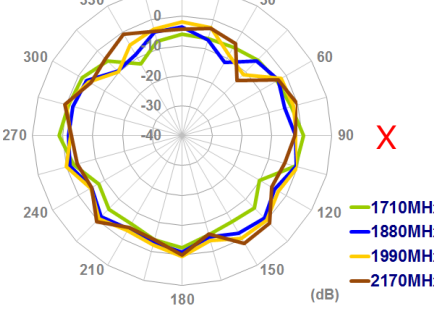

YZ Plane

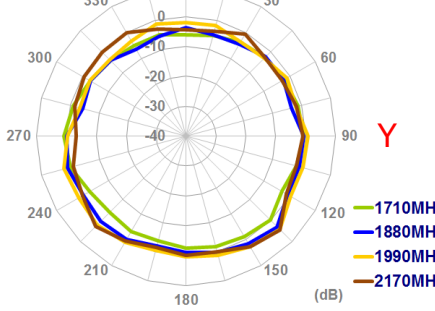

XY Plane

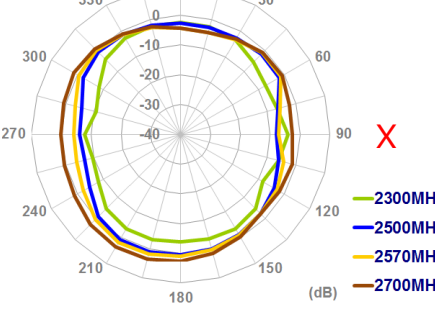

XZ Plane

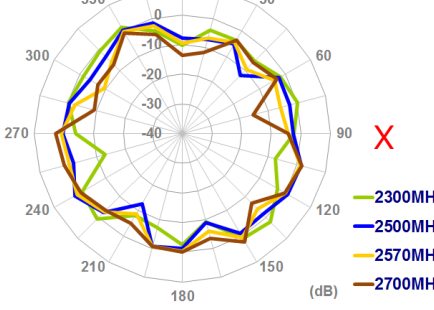

YZ Plane

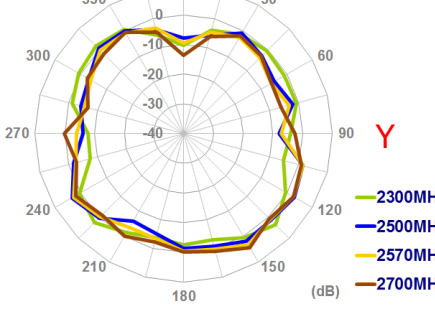

#### 4.7. Antenna Setup – Bent At 90 Degrees With 15cm X 9cm Ground Plane

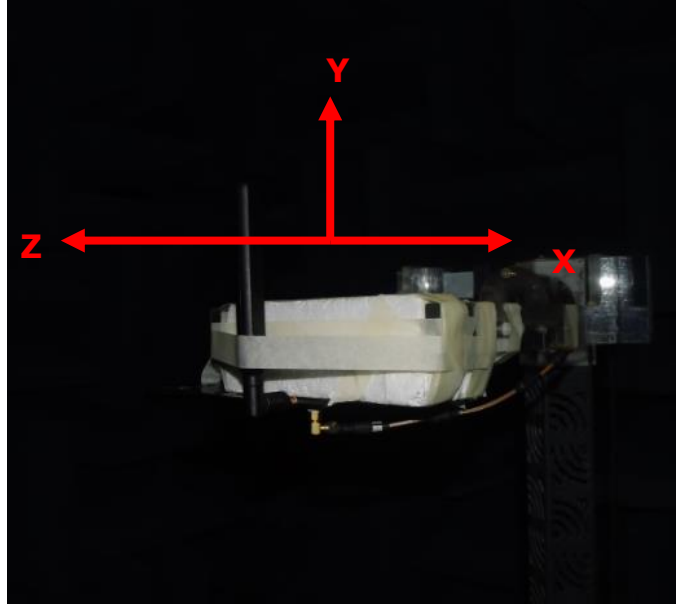

Antenna bent 90 degrees with 15cm X 9cm ground plane

**4.8. Antenna Radiation Patterns**

XY Plane

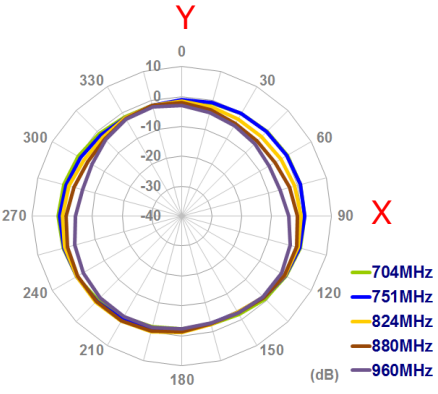

XZ Plane

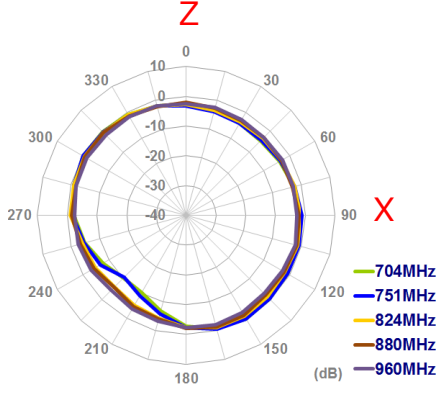

YZ Plane

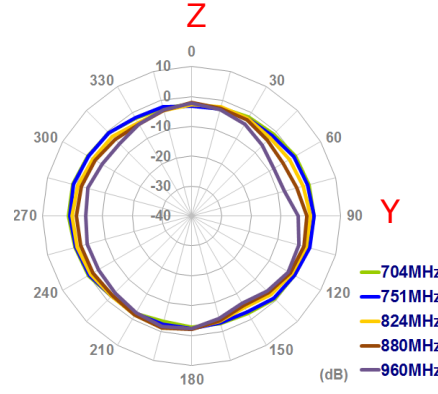

Y

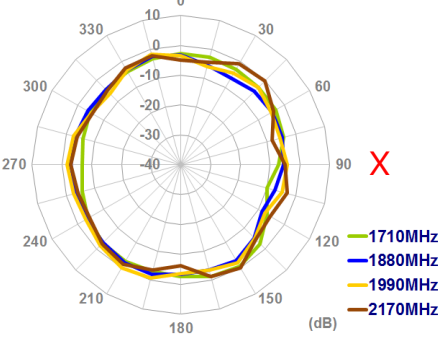

Z

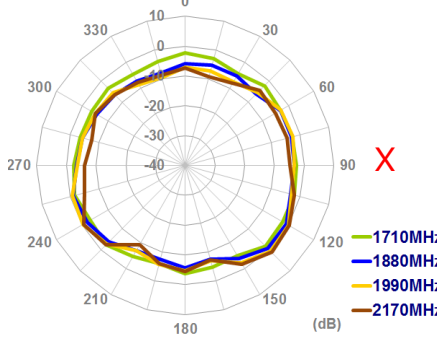

Z

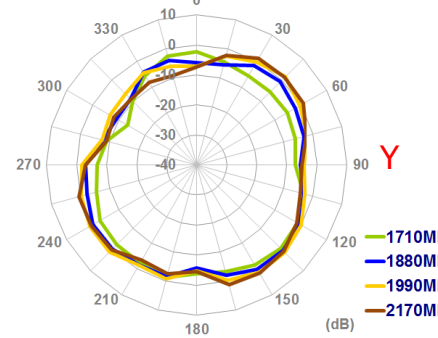

Y

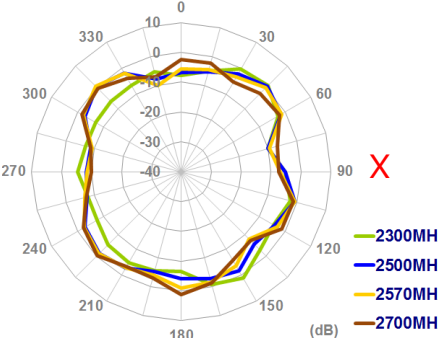

Z

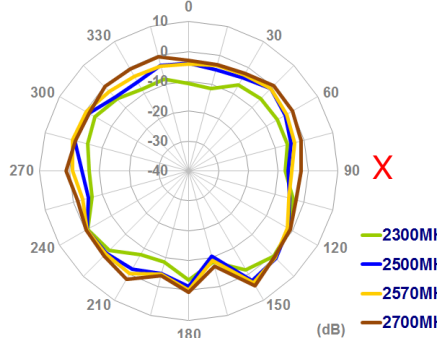

Z

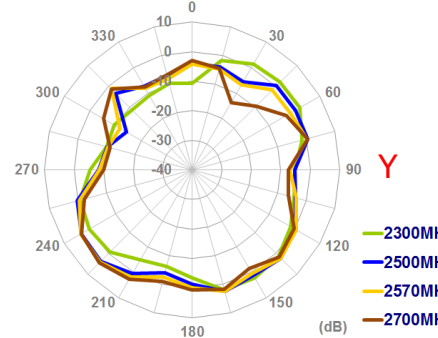



**TAOGLAS®**

#### **4.9. Antenna Setup – Straight With 30cm X 30cm Ground Plane Edge**

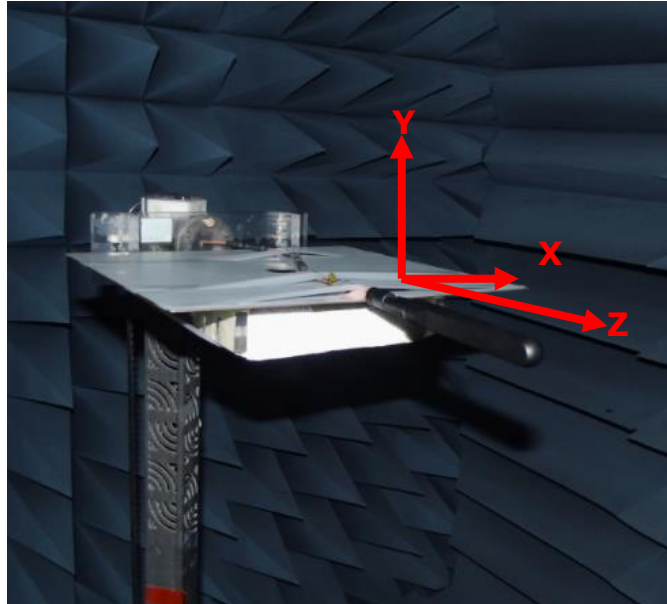

**Antenna straight with 30cm X 30cm ground plane edge**





## 4.10. Antenna Radiation Patterns

XY Plane

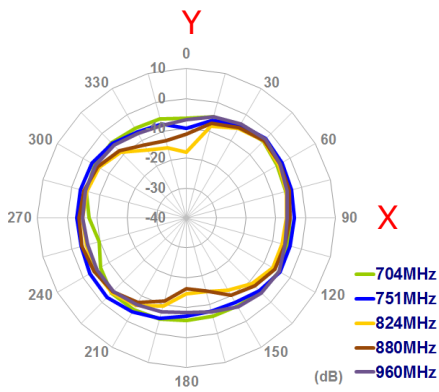

XZ Plane

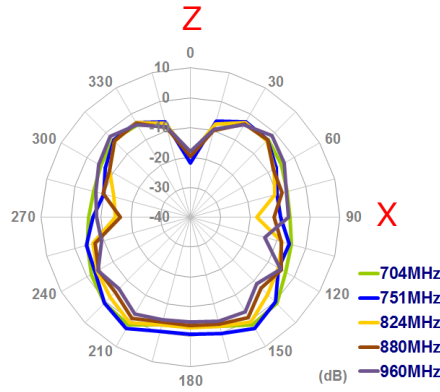

YZ Plane

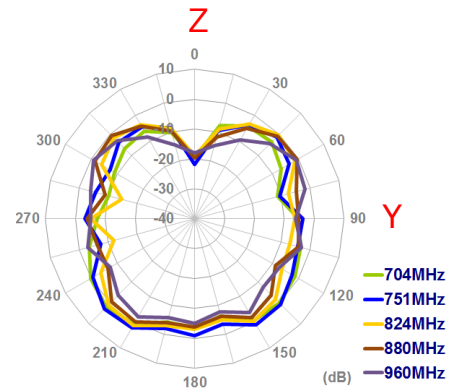

XY Plane

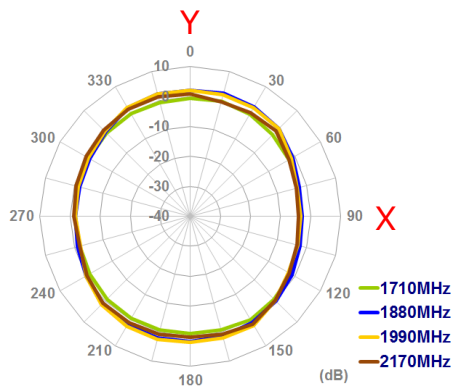

XZ Plane

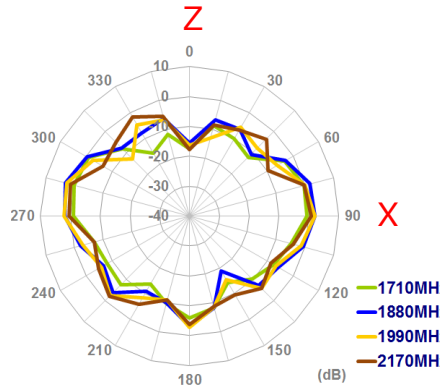

YZ Plane

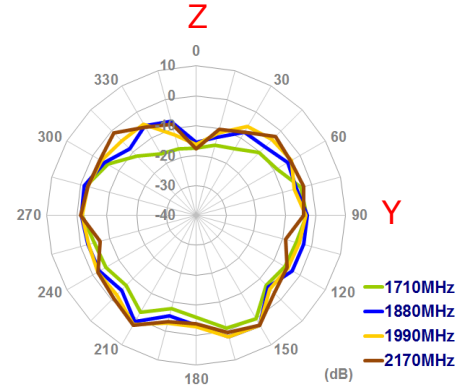

XY Plane

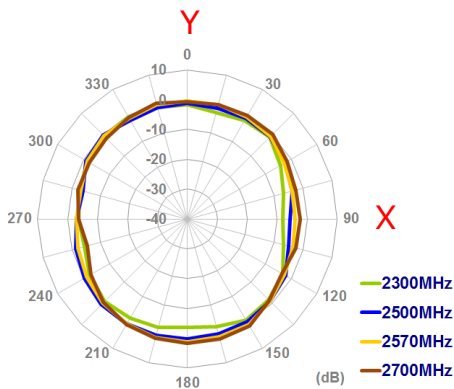

XZ Plane

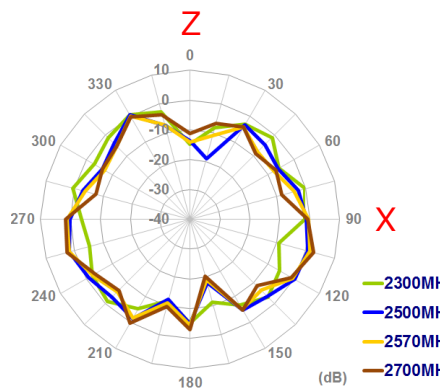

YZ Plane

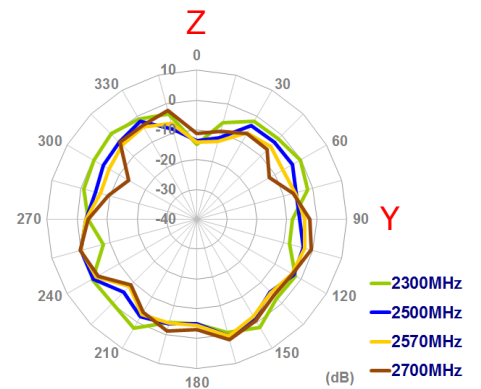



#### 4.11. Antenna Setup – Bent At 90 Degrees With 30 X 30cm Ground Plane Edge

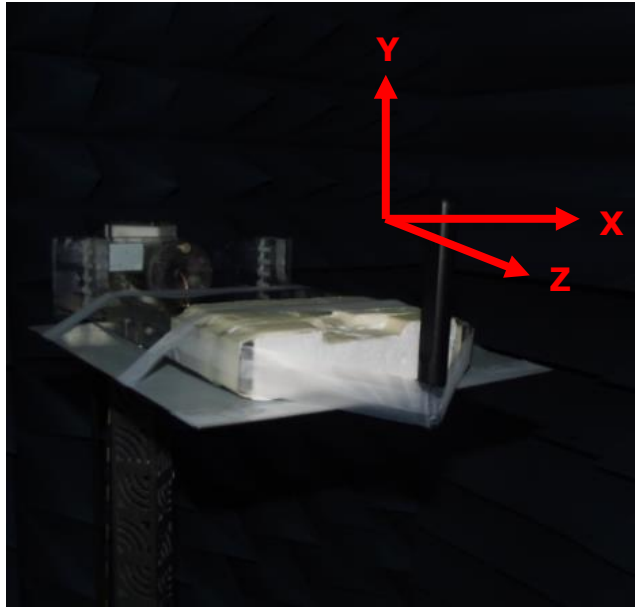

Antenna bent 90 degrees with 30cm X 30cm ground plane edge

**4.12. Antenna Radiation Patterns**

XY Plane

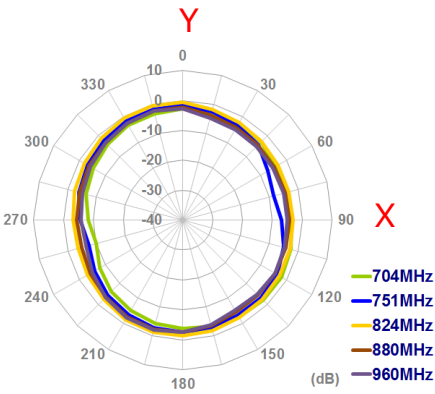

XZ Plane

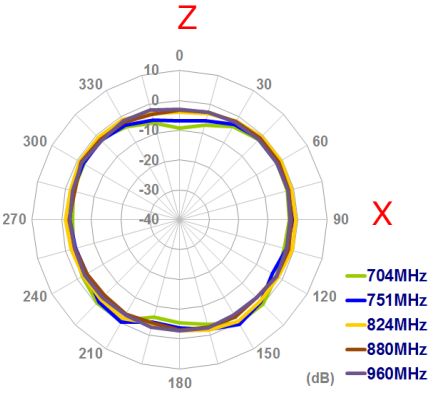

YZ Plane

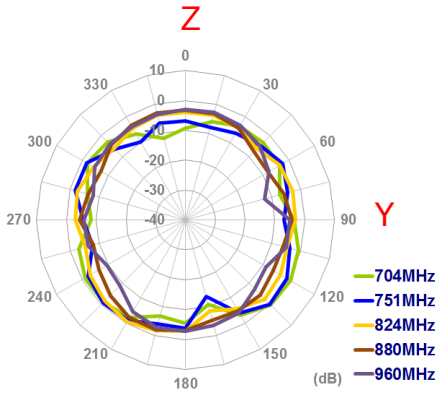

Y

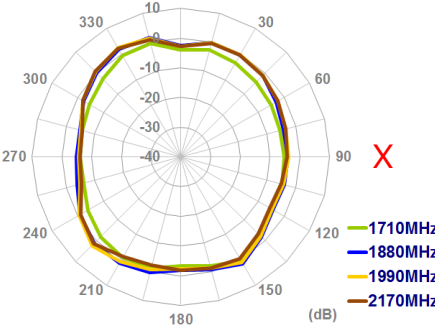

Z

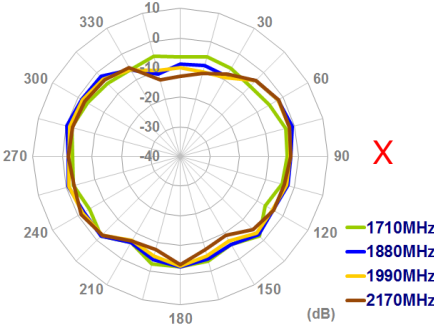

Z

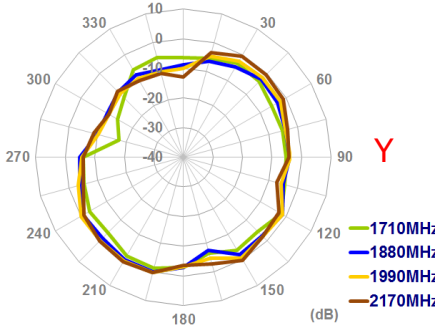

Y

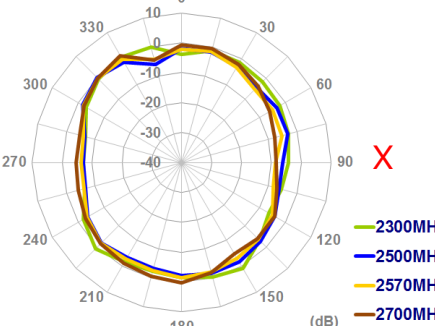

Z

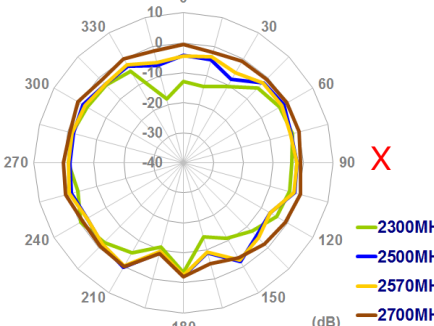

Z

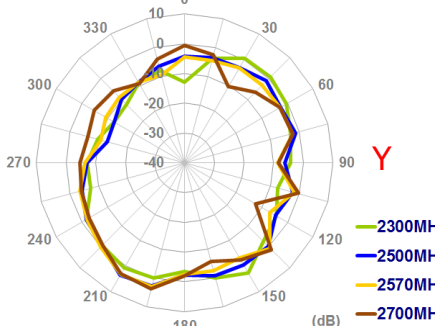

#### 4.13. Antenna Setup – Straight with 30cm X 30cm Ground Plane Center

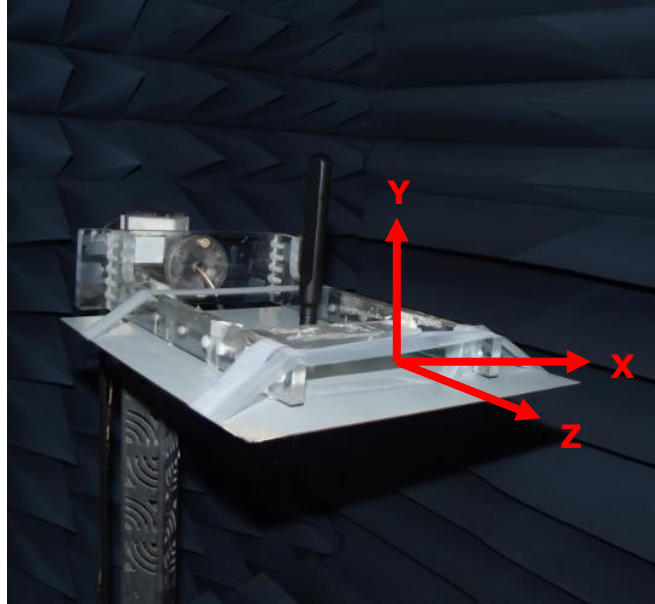

**Antenna straight with 30cm x 30cm ground plane center**



## 4.14. Antenna Radiation Patterns

XY Plane

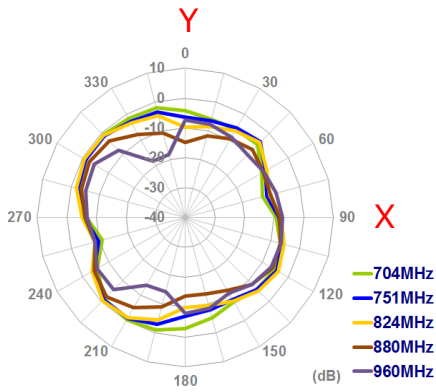

XZ Plane

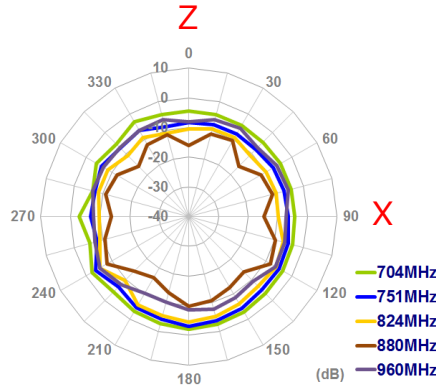

YZ Plane

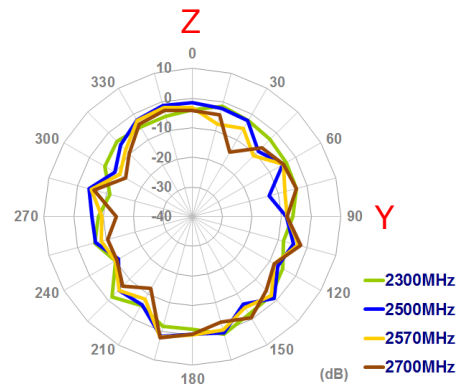
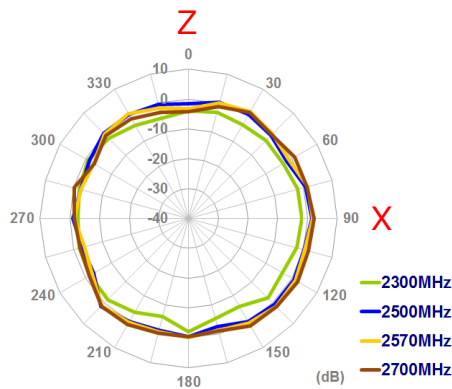
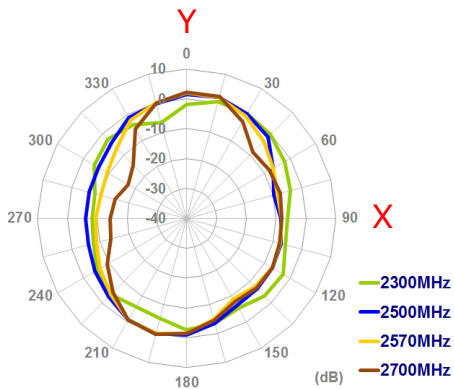
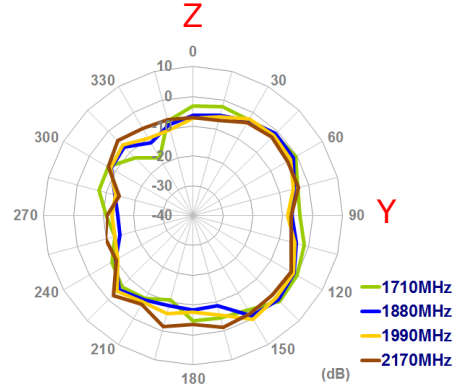
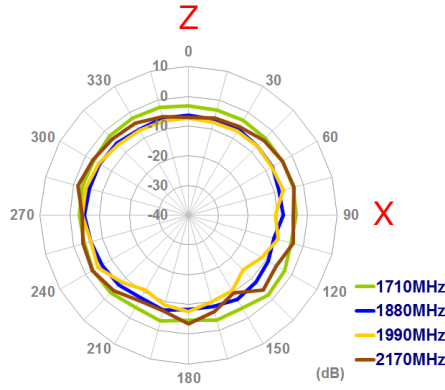
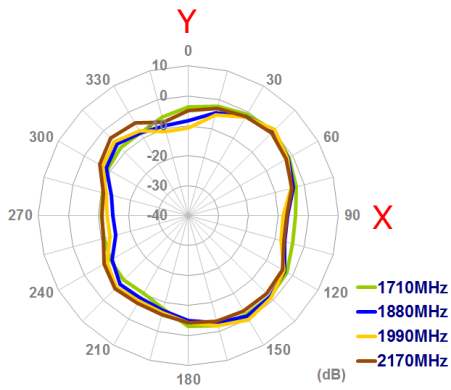
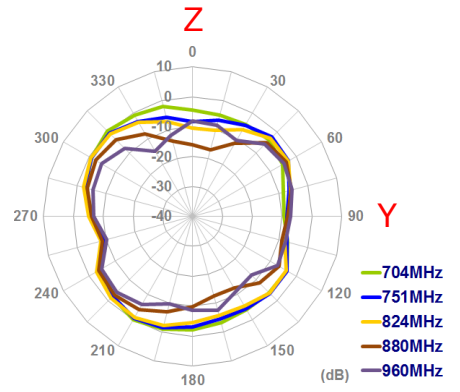

#### 4.8 Antenna Setup – bent At 90 Degrees With 30cm X 30cm Ground Plane Center

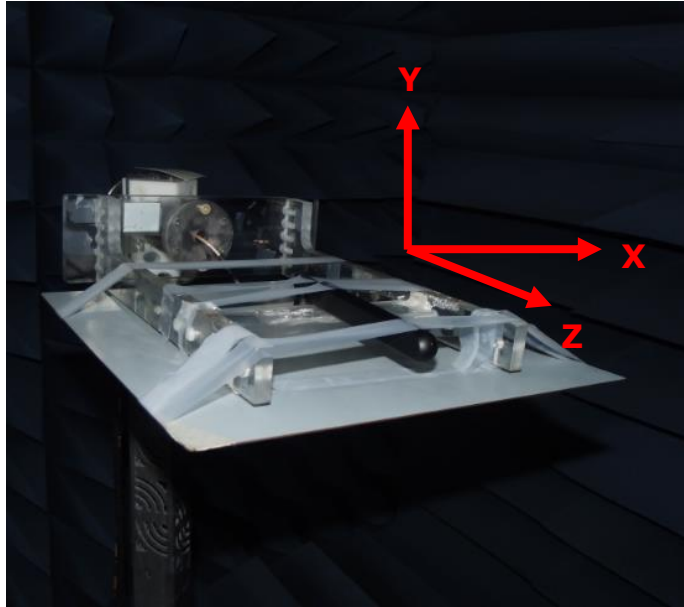

Antenna bent 90 degrees with 30cm x 30cm ground plane center

**4.15. Antenna Radiation Patterns**

XY Plane

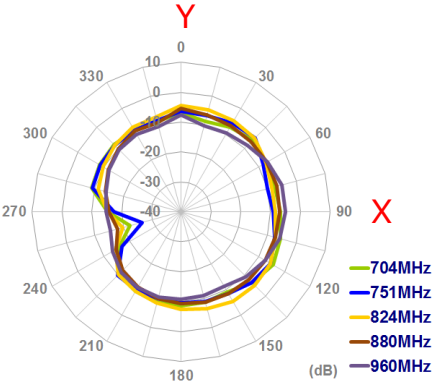

XZ Plane

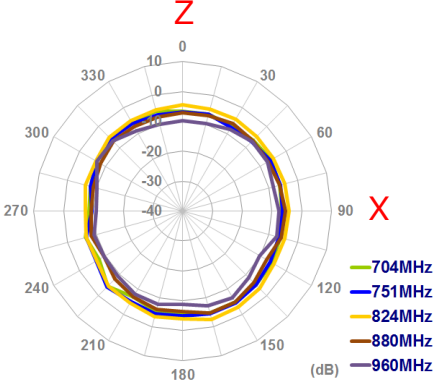

YZ Plane

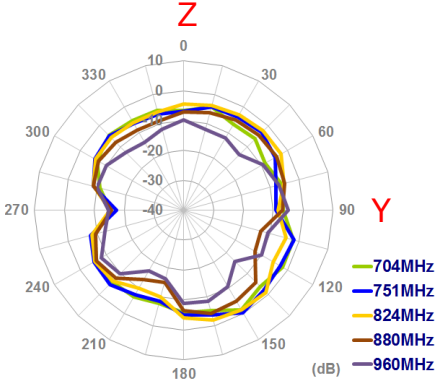

Y

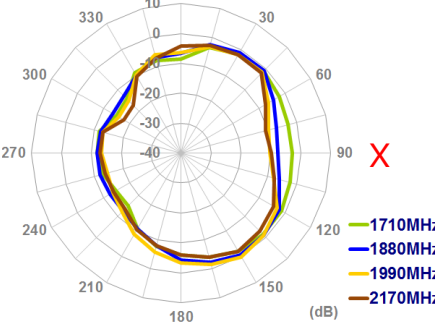

Z

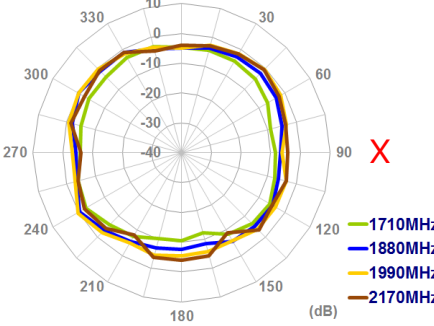

Z

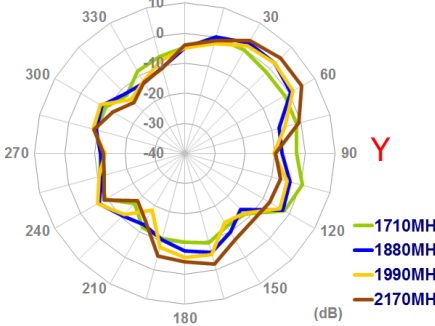

Y

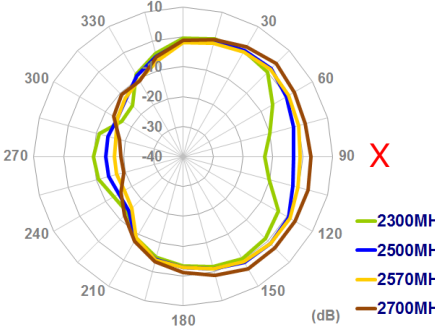

Z

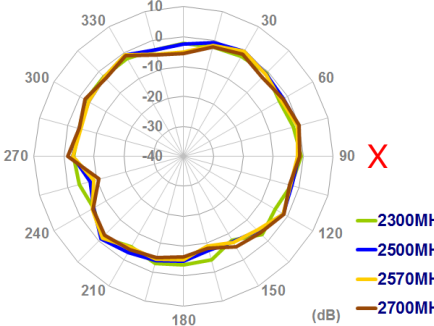

Z

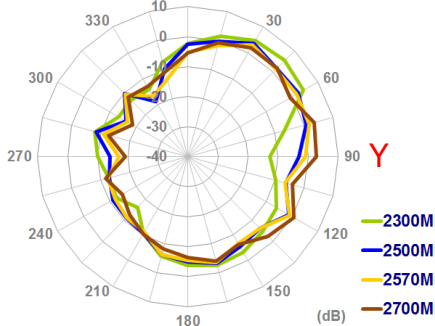



## 5. Drawing

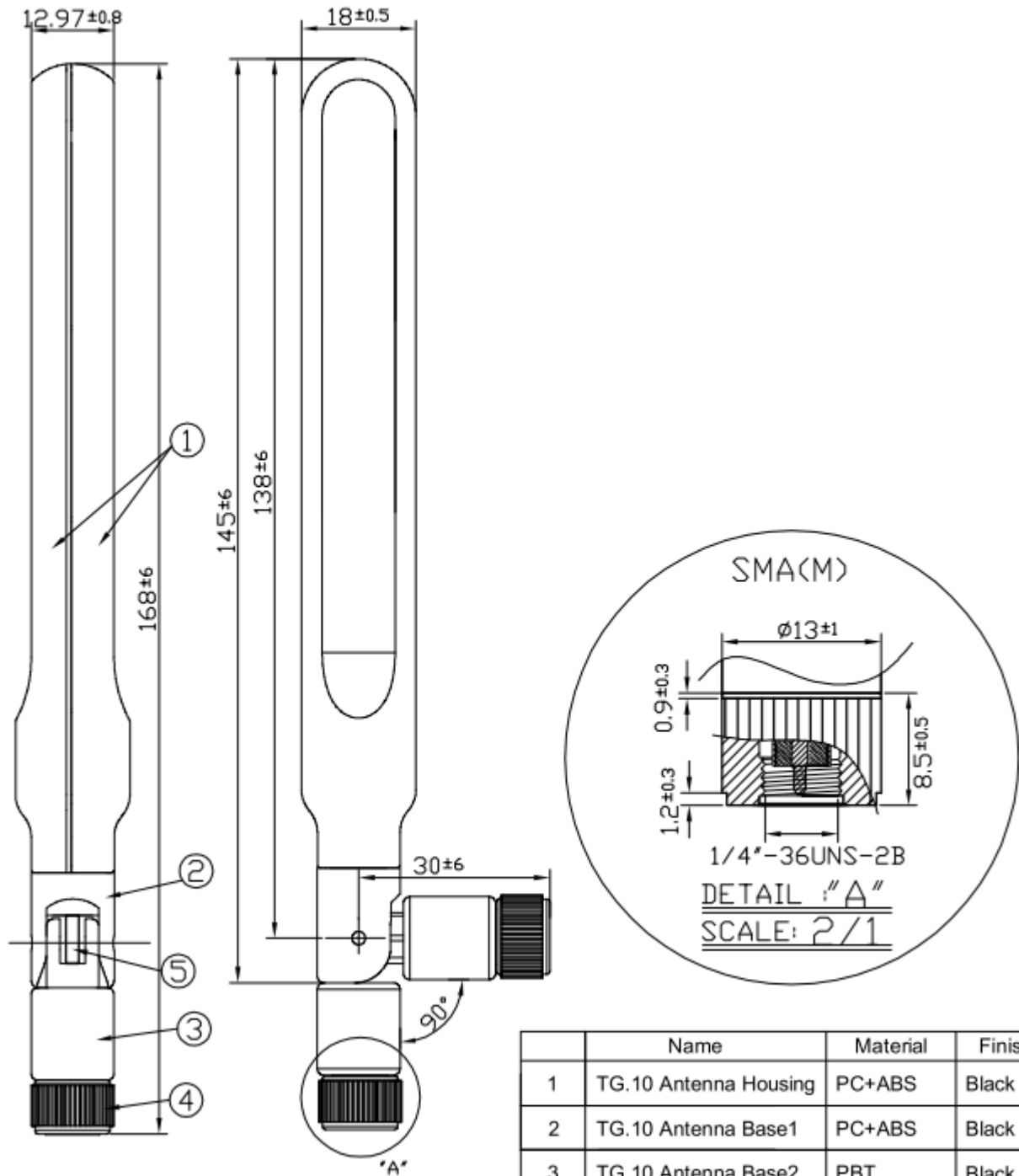

	Name	Material	Finish	QTY
1	TG.10 Antenna Housing	PC+ABS	Black	2
2	TG.10 Antenna Base1	PC+ABS	Black	1
3	TG.10 Antenna Base2	PBT	Black	1
4	SMA(M)	Brass	Black	1
5	RG178 Cable	RG178	Brown	1





# TAOGLAS®

## 6. Packaging

10pc TG.10.0113 per PE Bag  
Bag Dimensions - 260\*105mm  
Weight - 0.23Kg



50pc TG.10.0113 per SPQ Bag  
Bag Dimensions - 270\*420mm  
Weight - 1.2Kg

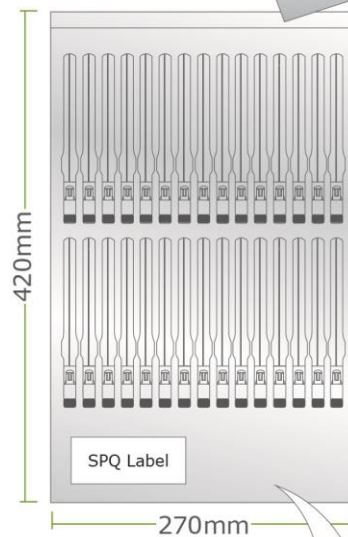

300pcs TG.10.0113 per Carton  
Carton Dimensions - 400\*330\*220mm  
Weight - 8Kg

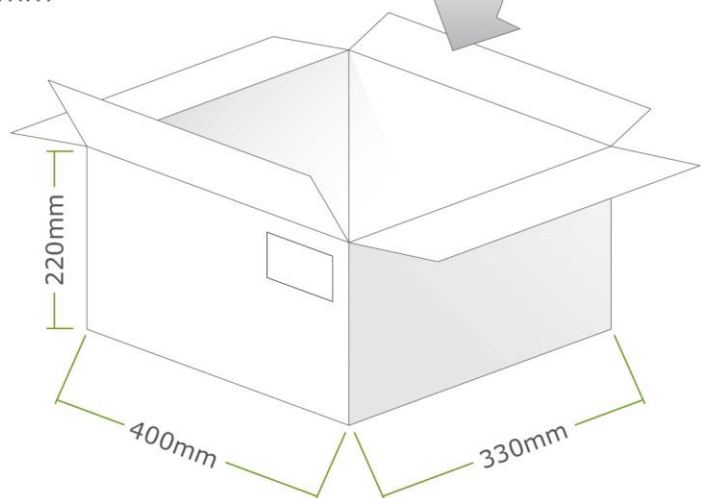

## 7. Installation

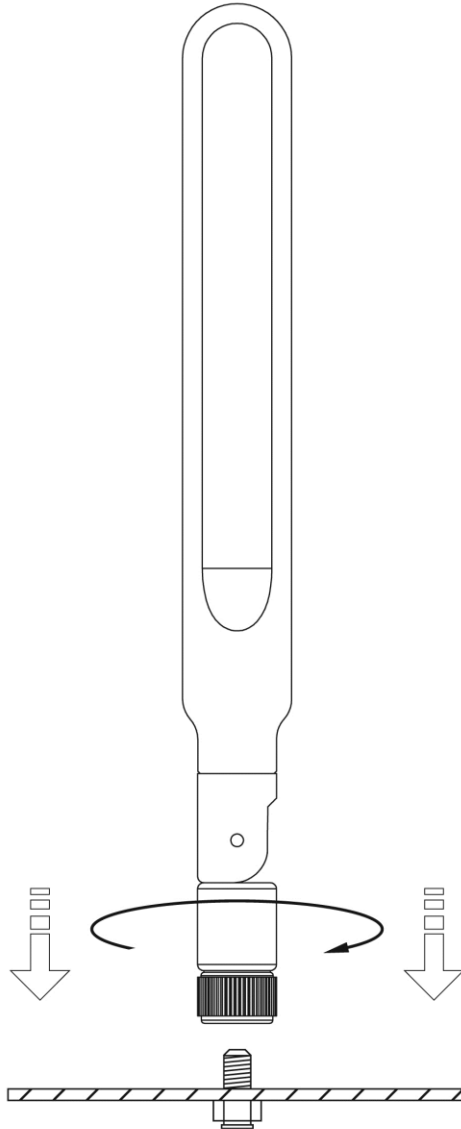

Recommended torque for mounting is 0.9 N·m  
Maximum torque for mounting is 1.176 N·m

Taoglas makes no warranties based on the accuracy or completeness of the contents of this document and reserves the right to make changes to specifications and product descriptions at any time without notice. Taoglas reserves all rights to this document and the information contained herein.

Reproduction, use or disclosure to third parties without express permission is strictly prohibited.

Copyright © Taoglas Ltd.