

IEC Appliance Inlet C20, Screw-on Mounting, Rear Side, PCB Terminal



See below:
[Approvals and Compliances](#)

Description

- Panel Mount :
- Screw-on mounting , from rear-side
- Appliance Inlet , Pin temperature 70 °C , Protection class I
- For PCB mounting

References

We recommend for new applications the type [GSP4](#)

Weblinks

[pdf datasheet](#), [html-datasheet](#), [General Product Information](#), [Distributor-Stock-Check](#), [Accessories](#), [Detailed request for product](#), [Microsite](#)

Technical Data

Ratings IEC	16 A / 250 VAC; 50 Hz	appliance inlet/-outlet	C20 acc. to IEC 60320-1
Ratings UL/CSA	20 A / 250 VAC; 60 Hz		UL 60320-1, CSA C22.2 no. 60320-1
Dielectric Strength	> 3 kVAC between L-N > 1.5 kVAC between L/N-PE (1 min/50 Hz)		(for cold conditions) pin-temperature 70 °C, 16 A, Protection Class I
Allowable Operation Temperature	-25 °C to 70 °C		
IP-Protection	from front side IP 20 acc. to IEC 60529		
Insulation cover	Suitable for appliances with protection class I acc. to IEC 61140		
Terminal	For PCB mounting Solder terminal straight		
Material: Housing	Thermoplastic, black, UL 94V-0		

Approvals and Compliances

Detailed information on product approvals, code requirements, usage instructions and detailed test conditions can be looked up in [Details about Approvals](#)

Approvals

The approval mark is used by the testing authorities to certify compliance with the safety requirements placed on electronic products.

Approval Reference Type: 1601

Approval Logo	Certificates	Certification Body	Description
	KEMA Approvals	KEMA	Certificate Number:
	UL Approvals	UL	UL File Number: E96454
	CQC Approvals	CQC	CCC Certificate Number:

Product standards

Product standards that are referenced

Organization	Design	Standard	Description
	Designed according to	IEC 60320-1	Appliance couplers for household and similar general purposes
	Designed according to	UL 60320-1	Standard for Attachment Plugs and Receptacles
	Designed according to	CSA C22.2 no. 60320-1	General Use Receptacles, Attachment Plugs, and Similar Wiring Devices





Application standards

Application standards where the product can be used

Organization	Design	Standard	Description
	Designed for applications acc.	IEC/UL 60950	IEC 60950-1 includes the basic requirements for the safety of information technology equipment.

Compliances

The product complies with following Guide Lines

Identification	Details	Initiator	Description
	CE declaration of conformity	SCHURTER AG	The CE marking declares that the product complies with the applicable requirements laid down in the harmonisation of Community legislation on its affixing in accordance with EU Regulation 765/2008.
	RoHS	SCHURTER AG	EU Directive RoHS 2011/65/EU
	China RoHS	SCHURTER AG	The law SJ / T 11363-2006 (China RoHS) has been in force since 1 March 2007. It is similar to the EU directive RoHS.
	REACH	SCHURTER AG	On 1 June 2007, Regulation (EC) No 1907/2006 on the Registration, Evaluation, Authorization and Restriction of Chemicals 1 (abbreviated as "REACH") entered into force.

Dimensions [mm]

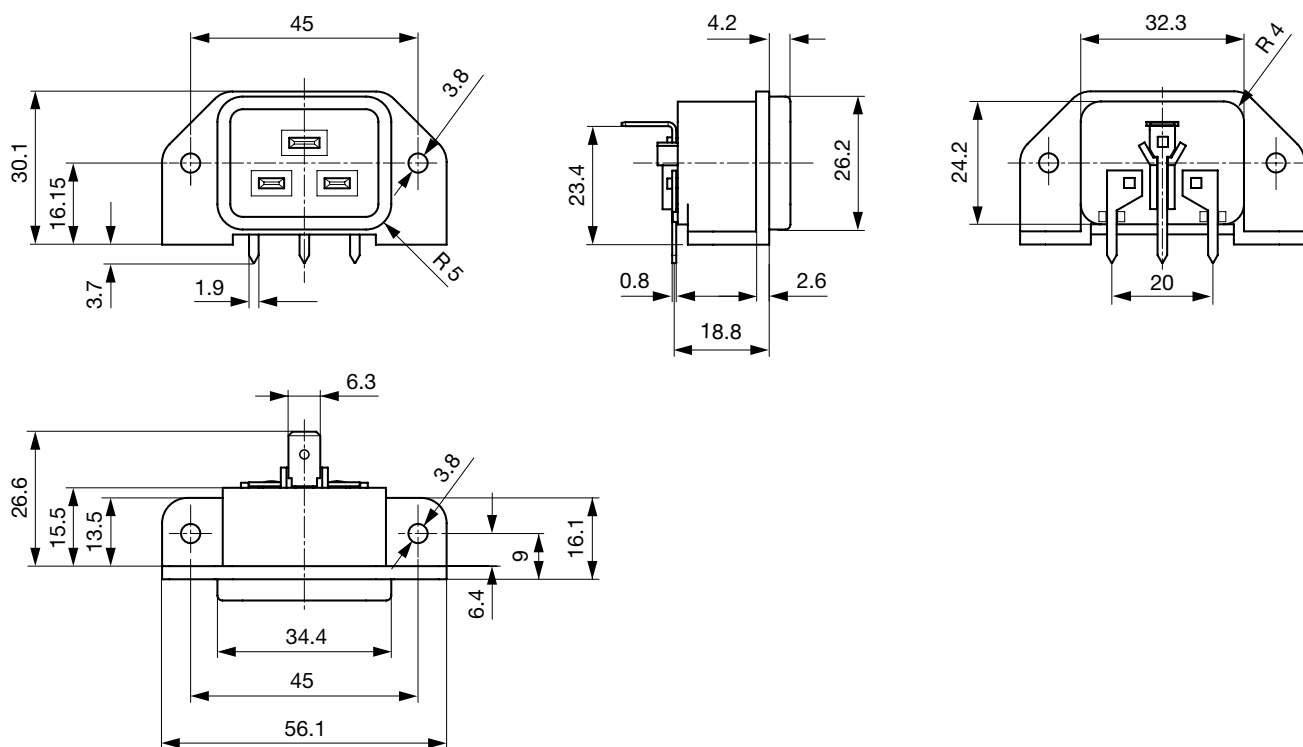

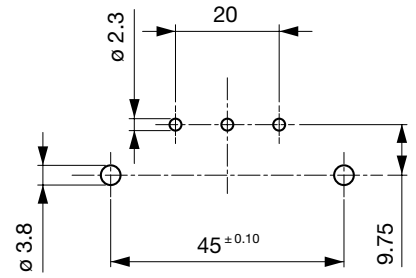
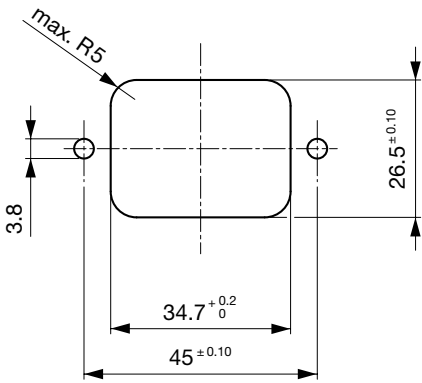

Panel cut-out and Drilling diagram

Config. Code

1601 - H - A B C 0 - D - E I

The characters are placeholders for the correspondingly keys of selections from the key tables.

1601 - H - A B C 0 - D - E I = Type

Type	Configuration key
protection class I	X

1601 - H - A B C 0 - D - E I = Terminals

Terminal L	Configuration key
PCB-terminal standard 	4

1601 - H - A B C 0 - D - E I = Terminals

Terminal N	Configuration key
PCB-terminal standard	4

Symbols similar as in table A

1601 - H - A B C 0 - D - E I = Terminals

Terminal Ground	Configuration key
PCB-terminal long (additional quick-connect terminal 6.3 x 0.8 mm)	6

Symbols similar as in table A

1601 - H - A B C 0 - D - E I = Color

Color	Configuration key
Black	A

1601 - H - A B C 0 - D - E I = Style

Style	Configuration key
flange with through holes	2

1601 - H - A B C 0 - D - E I = Additional Terminals

Additional Terminals	Configuration key
without additional terminal on L and N	0
additional quick connect terminal 6.3 x 0.8 mm on L and N	9

All Variants

Terminals L / N	Terminal Ground	Color	Additional Terminals	Config. Code	Order Number
PCB-terminal standard	PCB-terminal long (additional quick-connect terminal 6.3 x 0.8 mm)	Black	additional quick connect terminal 6.3 x 0.8 mm on L and N	1601-X-4460-A-29	6163.0018
PCB-terminal standard	PCB-terminal long (additional quick-connect terminal 6.3 x 0.8 mm)	Black	without additional terminal on L and N	1601-X-4460-A-20	6163.0019

The listed variants should be available from stock. Other versions on request www.schurter.com/contact

Most Popular.

Availability for all products can be searched real-time: <https://www.schurter.com/en/Stock-Check/Stock-Check-SCHURTER>

Packaging unit 50 Pcs

Mating Outlets/Connectors

Category / Description



Connector Overview complete

IEC Connector C19, Rewireable, Straight	4795
IEC Connector C19, Rewireable, Angled	4790
IEC Connector C19, Rewireable, Straight	0104U

[Connector further types to 1601](#)



Power Supply Cord Overview complete

Cord Sets 16 A, Europlug, 2.5 m, Connector IEC C19, H05VV-F3G1.5, black	6004.0395
Cord Sets 16 A, Interconnection, 1.0 m, Connector IEC C19, H05VV-F3G1.5, black	6020.0392
Cord Sets 16 A, Interconnection, 2.0 m, Connector IEC C19, H05VV-F3G1.5, black	6020.0394
Cord Sets 16 A, North America, 2.5 m, Connector IEC C19, SJT 3x14 AWG, black	6009.5195

[Power Supply Cord further types to 1601](#)

Mating Outlets/Connectors shuttered



Power Cord Overview complete

Overview Power Cord with IEC Appliance Connector C19, V-Lock, straight	VAC19KS
------------------------------------------------------------------------	---------

[Power Cord further types to 1601](#)