

ACPF-7003

High Rx and Image Rejection Tx Filter for US PCS Band



Data Sheet

General Description

The ACPF-7003 is a high rejection full band transmit filter designed for US PCS handsets. Its performance rivals split-band surface acoustic wave (SAW) transmit filters. Since a single filter provides the rejection, no switches are required, saving board space and external components, eliminating switch loss, and reducing programming complexity. Furthermore, with 25dB rejection at 1830 MHz, it is a true split band replacement.

The ACPF-7003 FBAR transmit filter utilizes Avago Technologies' Microcap bonded-wafer chip scale packaging technology. This process allows the ultra small filters to be assembled into a Molded Chip on Board (MCOB) Module.

In typical cellular phone architectures, the transmit filter fits between the driver amplifier and the power amplifier. This filter reduces the noise in the Rx band being amplified by the transmit chain, enhancing receiver sensitivity. High rejection keeps unwanted signals out of the receive path.

Avago Technologies' thin-Film Bulk Acoustic Resonator (FBAR) technology makes possible high-Q filters at a fraction their usual size.

Features

- High rejection from a single filter with no switches required
- True split band replacement
- Passband: 1850-1910 MHz
- 35 dB min Attenuation, 1930-1990 MHz
- 2.5 dB Typical Insertion Loss
- 25dB image rejection at 1830 MHz
- Space saving solution
 - Small footprint: 1.6 x 2.0-mm solution
 - Low profile package: 0.9 mm high (Typ)
 - 1.0mm (Max)

Applications

- US PCS band handsets
- Wireless Data terminals

Electrical Specifications, $Z_0=50\ \Omega$

Symbol	Parameters	Units	+25° C			-30° to +85° C		
			Min	Typ	Max	Min	Typ	Max
f	Passband [1850.6 - 1909.4]	MHz						
IL	Insertion Loss 1850.6-1855 MHz	dB		2.0	3.5			3.5
IL	Insertion Loss 1855-1905 MHz	dB		1.5	2.5			2.5
IL	Insertion Loss 1905-1909.4 MHz	dB		2.5	3.0			3.0
D S21	Ripple, 1850-1910 MHz	dB			2.5			
S21	Min Rejection, 1930.6-1990 MHz	dB	35	45		35	45	
S21	Min Rejection 10 -1715 MHz	dB	25			25		
S21	Min Rejection 1715 - 1785 MHz	dB	25			25		
S21	Min Rejection 1785 - 1830 MHz	dB	25			25		
S21	Min Rejection 1990 - 2500 MHz	dB	30			30		
S21	Min Rejection 2500 - 3820 MHz	dB	22			22		
S21	Min Rejection 3820 - 5730 MHz	dB	15			15		
S11, S22	In-band return loss	dB	10	13		10	13	
Pin max	Safe Input Power Level	dBm	20			20		

Absolute Maximum Ratings^[2]

Parameter	Unit	Value
Operating temperature ^[1]	°C	-30 to +85
Storage temperature ^[1]	°C	-40 to +125

Notes:

1. Temperature is defined at case T_C , the temperature of the underside of the filter where it makes contact with the circuit board.
2. Specifications are guaranteed over the given temperature range. Operation in excess of any one of these conditions may result in permanent damage to the device.

Typical Performance (25 C, Zo = 50 Ohms)

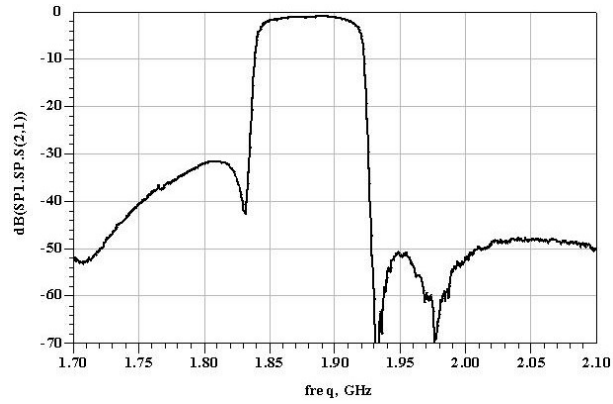

Figure 1. Attenuation (dB) vs. frequency

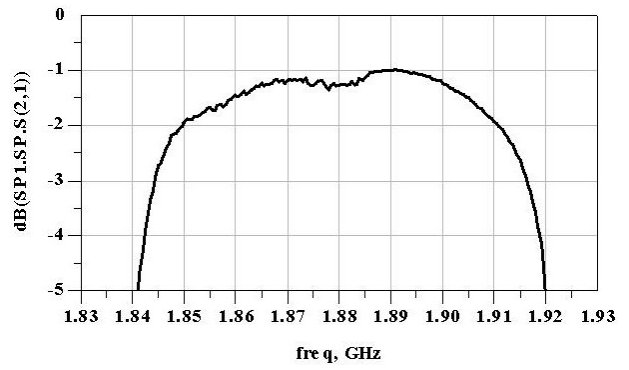

Figure 2. Insertion Loss (dB) vs. frequency

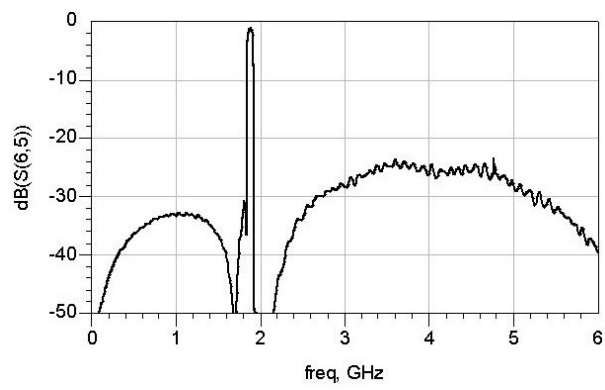

Figure 3. Attenuation (dB) vs. frequency (broadband)

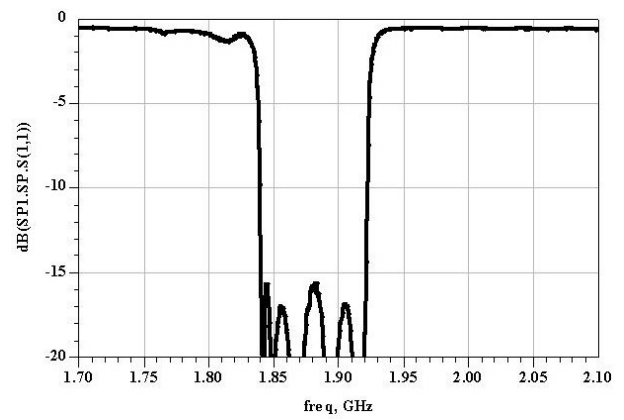

Figure 4. Return Loss (dB) vs. frequency

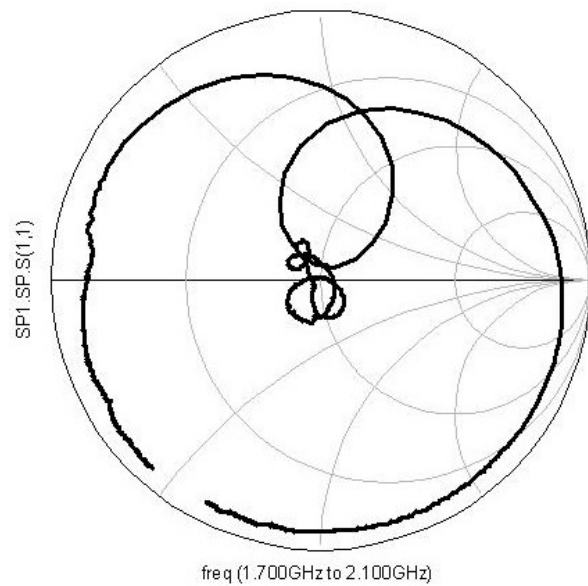

Figure 5. S(1,1)

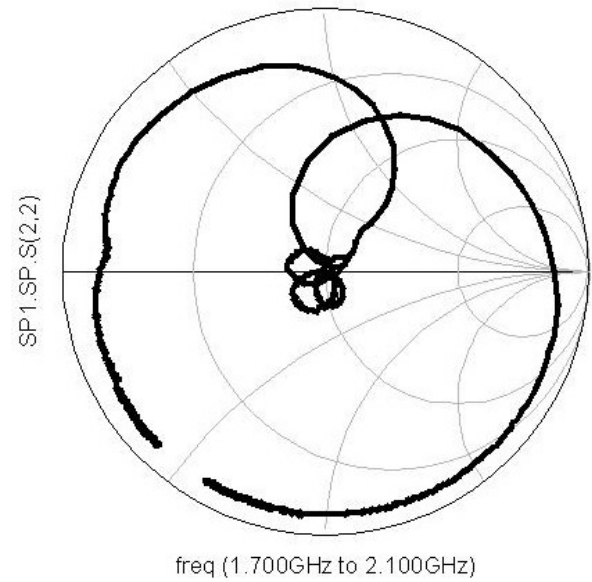

Figure 6. S(2,2)

PCB Interface & Mounting instructions

Mounting Consideration and board description

The ACPF-7003 FBAR filter has one input (Pin 1), one output (Pin 3) and two grounds (Pins 2 and 4.)

- Demo board uses 3 mil Getek Microstrip.

The demo board uses CPWG transmission lines for high isolation between the two ports. It uses via holes to connect the CPWG line from the underside of the board to the filter mounting pads on top.

Note: For best performance, try to reproduce this board stack up closely.
If Ground-Signal-Ground (GSG) type board is used, better return loss can be achieved since it eliminates connector mismatch.

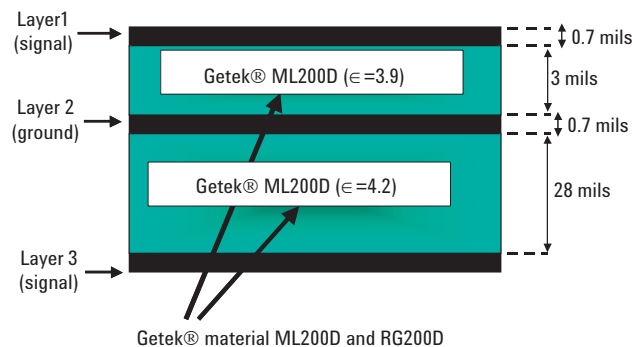

Figure 7. Board stack up description

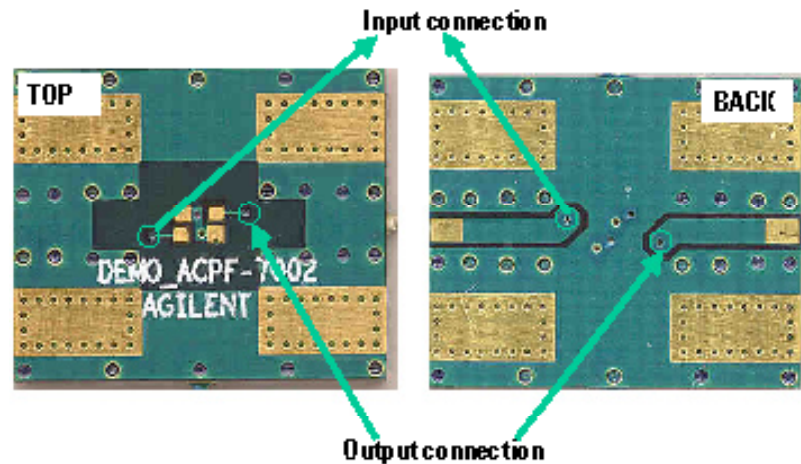

Figure 8. PCB Footprint pad

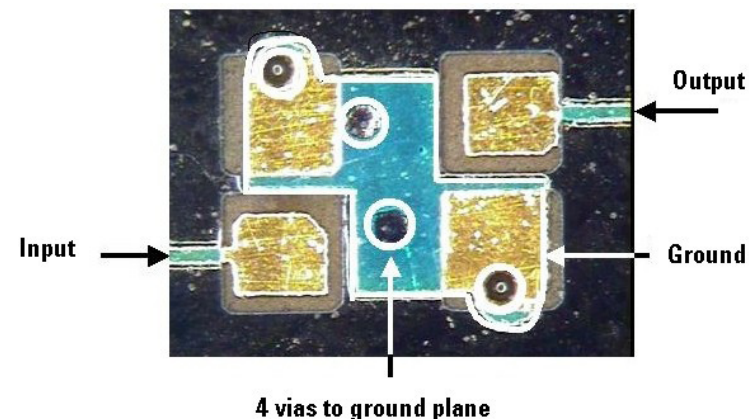

Figure 9. Closer look at the recommended board footprint and soldermask

Demo boards

Demo boards are available for sampling. (See board drawing in Figures 7, 8, and 9.)

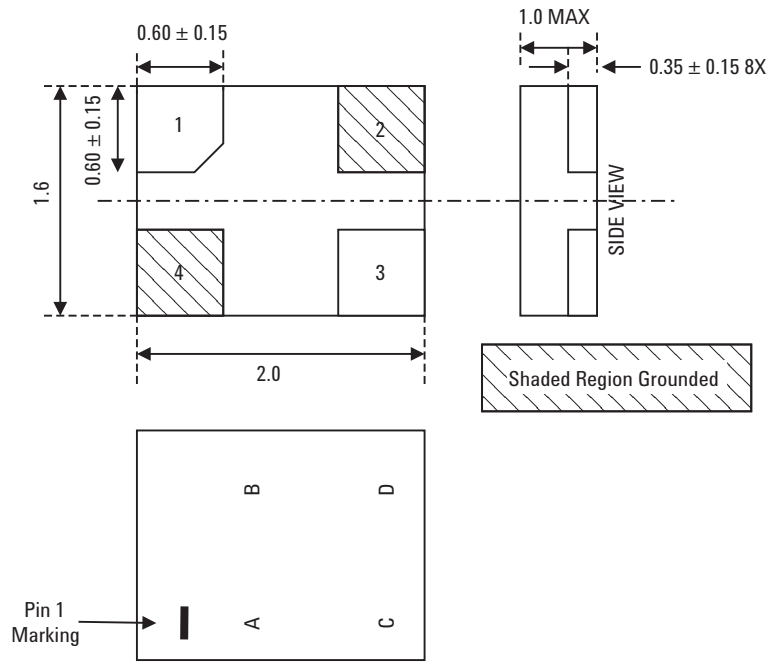

Figure 10. Detailed Bottom, Side and Top view of Package (dimensions in mm)

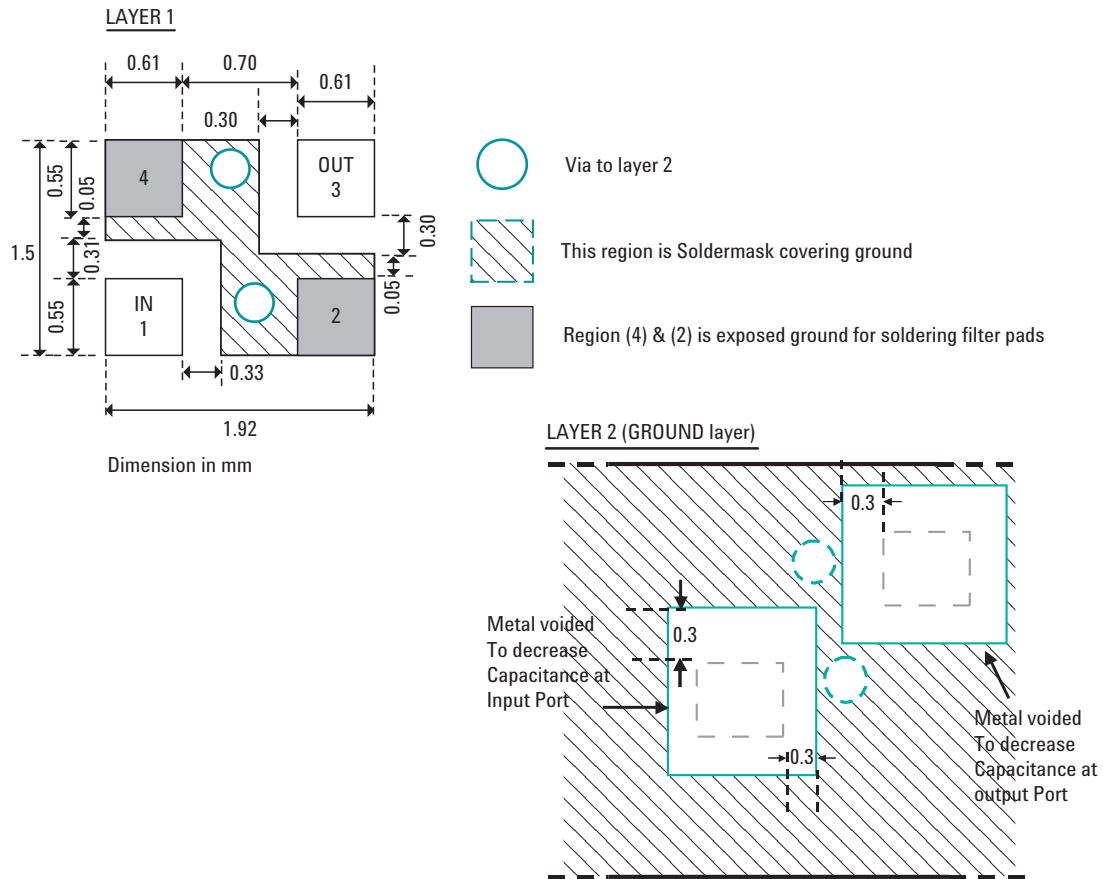

Figure 11. Suggested PCB layers

Alloy type	Melting temperature (°C)	Recommended working temperature (°C)	Alloy type	Melting temperature (°C)	Recommended working temperature (°C)
Sn42Bi58	138	160 - 180	Sn95.8Ag3.5Cu0.7	217	235 - 255
Sn43Pb43Bi14	144 - 163	165 - 185	Sn96.5Ag3.5	221	240 - 260
Sn63Pb37	183	200 - 240	Sn100	232	260 - 280
Sn60Pb40	186	200 - 240	Sn95Sb5	235	260 - 280
Sn91/Zn9	199	200 - 240	Sn97Cu3	240	260 - 300
Sn96.2Ag2.5Cu0.8Sb0.5	216	235 - 255			

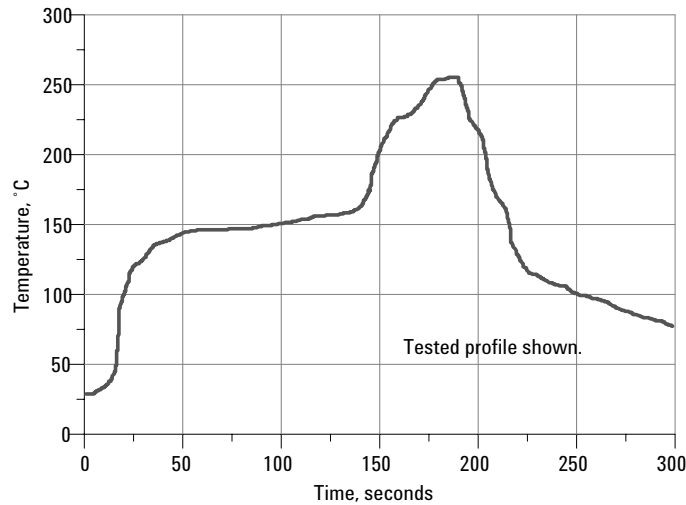
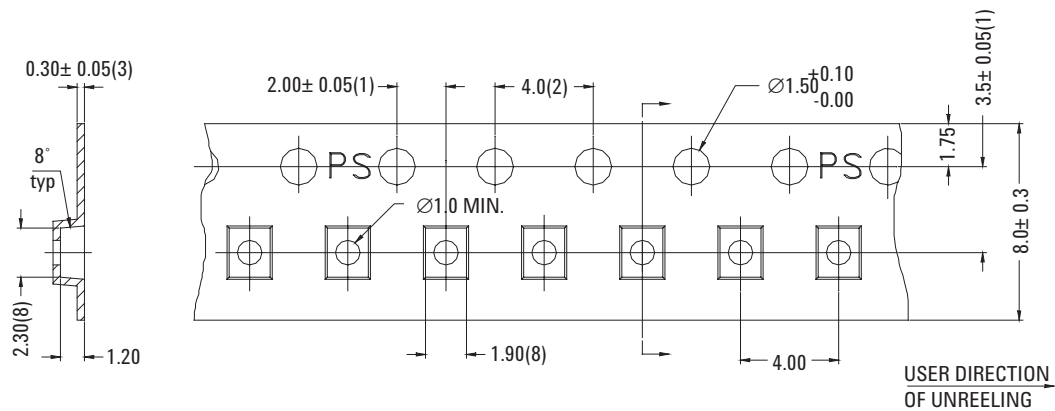

Figure 12. Recommended solder profile



NOTE:

1. MEASURED FROM THE CENTRELINE OF THE SPROCKET HOLE TO THE CENTRELINE OF THE POCKET HOLE AND FROM THE CENTRELINE OF THE SPROCKET HOLE TO THE CENTERLINE OF THE POCKET
2. CUMULATIVE TOLERANCE OF 10 SPROCKET HOLES IS ± 0.20
3. THIS THICKNESS IS APPLICABLE AS MEASURED AT THE EDGE OF THE TAPE.
4. MATERIAL: BLACK POLYSTYRENE
5. ALL DIMENSIONS IN MM.
6. ALLOWABLE CAMBER TO BE 1MM PER 250MM IN LENGTH
7. UNLESS OTHERWISE SPECIFIED TOLERANCE ± 0.10 .
8. MEASUREMENT POINT TO BE 0.3 FROM BOTTOM POCKET.
9. SURFACE RESISITIVITY FROM 1.0×10^5 TO 1.0×10^8 HOMS/SQ

Figure 13. Carrier tape drawing

Ordering Information

ACPF-7003-BLK = Bulk option,
100 pieces per antistatic bag

ACPF-7003-TR1 = Tape and reel option,
3000 pieces per 7-inch reel

For product information and a complete list of distributors, please go to our web site: www.avagotech.com

Avago, Avago Technologies, and the A logo are trademarks of Avago Technologies, Pte. in the United States and other countries.
Data subject to change. Copyright © 2006 Avago Technologies Pte. All rights reserved.
5989-3923EN - April 7, 2006

