



Spec. No.	PS-DS-S56124/S56125A9
Rev.	A

PRODUCT SPECIFICATION

Model No:CSS-S56124A9/S56125A9

Descriptions:

- 0.56 Inch Single Digit SMD Display
- Emitting Color : Super Bright Amber



CUSTOMER APPROVED SIGNATURES	APPROVED BY	CHECKED BY	PREPARED BY

CHINA SEMICONDUCTOR CORPORATION
Address:2FL. NO.909,Chung-Cheng Road,
Chung-Ho City Taipei Hsien,Taiwan.

Tel:886-2-2223-9696
Fax:886-2-2223-9377

OPTO PLUS TECHNOLOGIES CO.,LTD
Address:696 Shun jiang Rd.,Ji Shan St.Shaoxing,
ZheJiang,China

Tel:86-0575-88623888
Fax:86-0575-88623112



Model No : CSS-S56124/S56125A9

Features -

1. 0.56 inch (14.2mm) digit height.
2. Qualified according to JEDEC moisture sensitivity Level 2a.
3. RoHS compliant.
4. Low power consumption.
5. Easy mounting on P.C. board.

Device Selection Guide -

Model No.	Chip		Description
	Material	Emitting Color	
CSS-S56124A9	AlGaInP	Super Bright Amber	Common Anode
CSS-S56125A9	AlGaInP	Super Bright Amber	Common Cathode

Mechanical Dimensions -

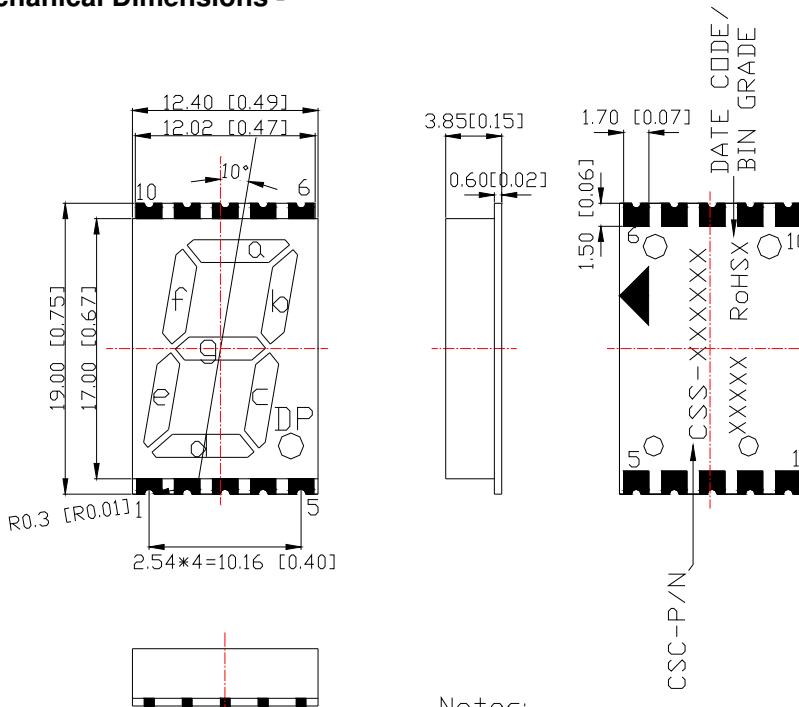

Notes:

All dimensions are in millimeters [inches], and tolerance is ± 0.25 [0.010] unless otherwise noted.



Model No : CSS-S56124/S56125A9

Internal Circuit Diagrams -

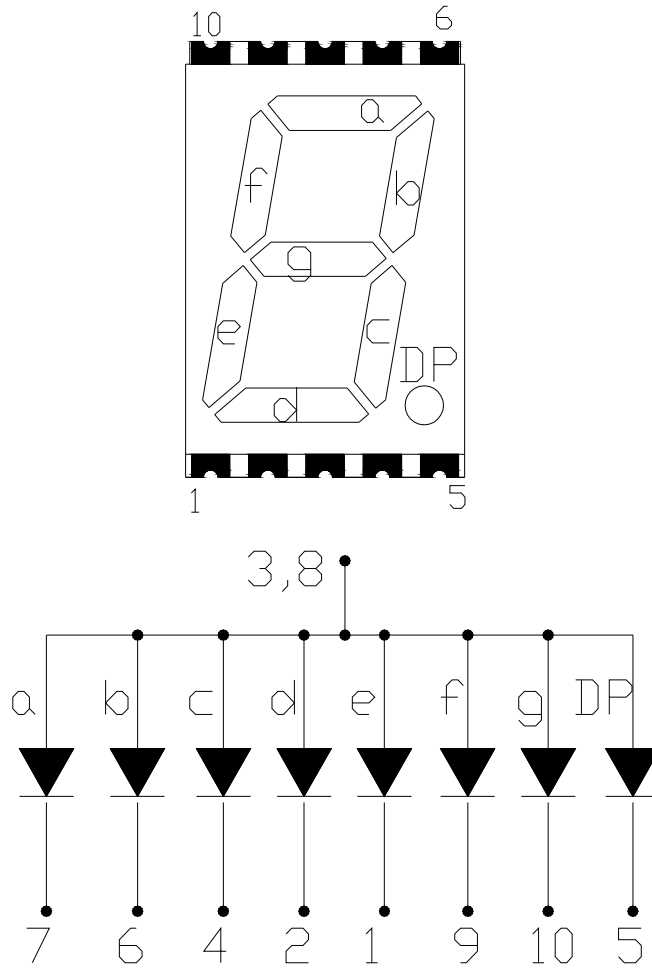

CSS-S56124 Common Anode
(CSS-S56125 Common Cathode)



Model No : CSS-S56124/S56125A9

■ Absolute Maximum Rating -

(Ta=25°C)

Parameter	Symbol	Rating	Unit
Power Dissipation Per Dice	P _{AD}	70	mW
Continuous Forward Current Per Dice	I _{AF}	25	mA
Peak Current Per Dice(duty cycle 1/10,1KHz)	I _{PF}	90	mA
Derating Linear From 25°C Per Dice	-	0.33	mA/°C
Reverse Voltage Per Dice	V _R	5	V
Operating Temp.	T _{opr}	-40 ~ +105	°C
Storage Temp.	T _{stg}	-40 ~ +105	°C

Note:Solder temperature 1/16 inch below seating plane for 3 seconds at 260°C

■ Electro-optical Characteristics -

(Ta=25°C)

Parameter	Symbol	Min.	Typ.	Max.	Unit	Condition
Forward Voltage Per Segment	V _F	-	2.0	2.8	V	I _F =20mA
Luminous Intensity Per Segment	I _v	8	20	-	mcd	I _F =10mA
Peak Emission Wavelength	λ _P	-	612	-	nm	I _F =20mA
Spectrum Radiation Bandwidth	Δλ	-	20	-	nm	I _F =20mA
Reverse Current	I _R	-	-	100	μA	V _R =5V
Luminous Intensity Matching Ratio	I _{V-m}	-	-	2:1	-	I _F =10mA



Model No : CSS-S56124/S56125A9

Typical Electrical / Optical Characteristics Curves -

(Ta = 25°C Unless Otherwise Noted)

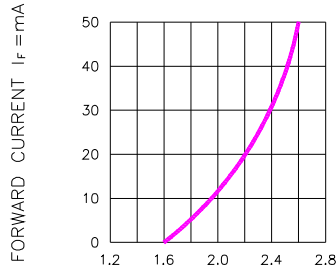

FORWARD VOLTAGE (V_F)—VOLTS
Fig.1 FORWARD CURRENT VS. FORWARD VOLTAGE

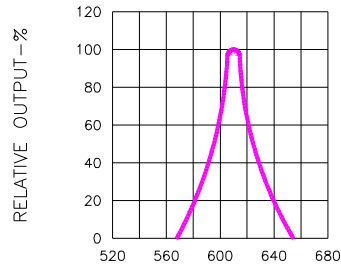

WAVELENGTH (λ)—nm
Fig.2 SPECTRAL RESPONSE

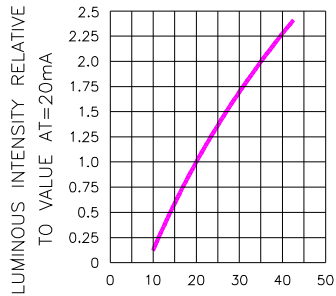

I_F—FORWARD CURRENT—mA
Fig.3 RELATIVE LUMINOUS INTENSITY VS. FORWARD CURRENT

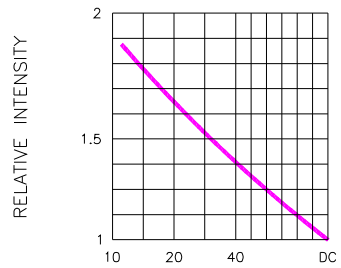

DUTY CYCLE % PER SEGMENT
(AVERAGE I_F=10mA)
Fig.5 LUMINOUS INTENSITY VS. DUTY CYCLE

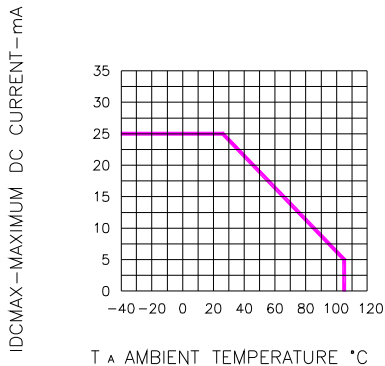

T_A AMBIENT TEMPERATURE °C
Fig.4 MAXIMUM ALLOWABLE DC CURRENT PER SEGMENT VS. A FUNCTION OF AMBIENT TEMPERATURE

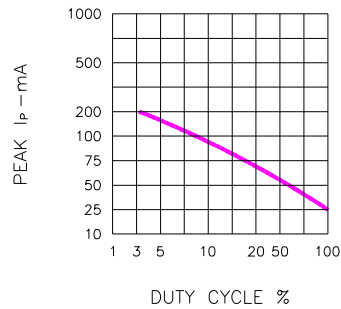

DUTY CYCLE %
Fig.6 MAX PEAK CURRENT VS. DUTY CYCLE %
(REFRESH RATE f=1 KHz)



Model No : CSS-S56124/S56125A9

SMT REFLOW SOLDERING INSTRUCTIONS

IR Reflow Temperature / Time :

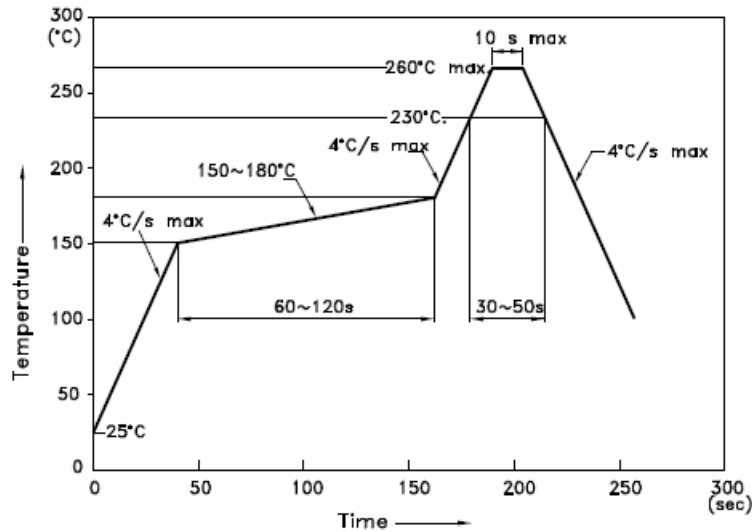

NOTES:

1. We recommend the reflow temperature 245°C(+/-5°C). The maximum soldering temperature should be limited to 260°C.
2. Don't cause stress to the epoxy resin while it is exposed to high temperature.
3. Number of reflow process shall be 2 times or less.

Soldering Pad Size

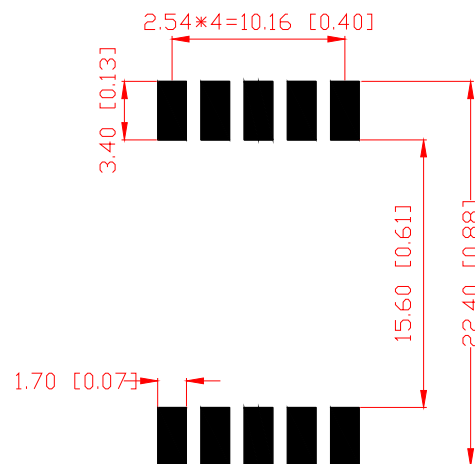



Model No : CSS-S56124/S56125A9

REEL DIMENSIONS

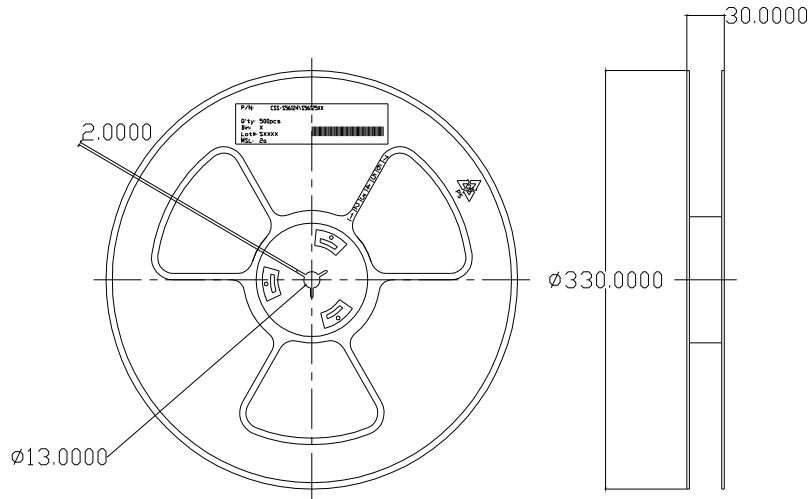

PACKING & LABEL SPECIFICATIONS

