

1.0A MINIATURE HIGH EFFICIENCY RECTIFIER

Features

- Diffused Junction
- Low Forward Voltage Drop
- High Current Capability
- High Reliability
- High Surge Current Capability

Mechanical Data

- Case: Molded Plastic
- Terminals: Plated Leads Solderable per MIL-STD-202, Method 208
- Polarity: Cathode Band
- Weight: 0.181grams (approx.)
- Mounting Position: Any
- Marking: Type Number

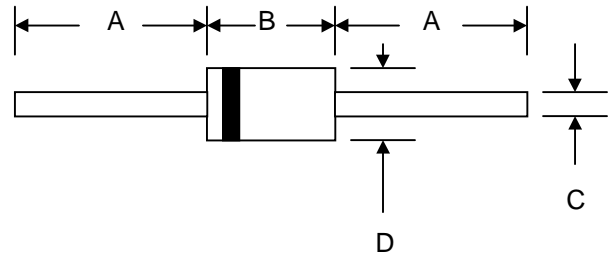

R-1		
Dim	Min	Max
A	20.0	—
B	2.00	3.50
C	0.53	0.64
D	2.20	2.60
All Dimensions in mm		

Maximum Ratings and Electrical Characteristics @ $T_A=25^{\circ}\text{C}$ unless otherwise specified

Single Phase, half wave, 60Hz, resistive or inductive load.
 For capacitive load, derate current by 20%.

Characteristic	Symbol	1H1	1H2	1H3	1H4	1H5	1H6	1H7	1H8	Unit	
Peak Repetitive Reverse Voltage	V_{RRM}									V	
Working Peak Reverse Voltage	V_{RWM}	50	100	200	300	400	600	800	1000		
DC Blocking Voltage	V_R										
RMS Reverse Voltage	$V_{R(RMS)}$	35	70	140	210	280	420	560	700	V	
Average Rectified Output Current (Note 1)	I_O	1.0								A	
Non-Repetitive Peak Forward Surge Current 8.3ms Single half sine-wave superimposed on rated load (JEDEC Method)	I_{FSM}	30								A	
Forward Voltage @ $I_F = 1.0\text{A}$	V_{FM}	1.0			1.3		1.7			V	
Peak Reverse Current @ $T_A = 25^{\circ}\text{C}$ At Rated DC Blocking Voltage @ $T_A = 100^{\circ}\text{C}$	I_{RM}	5.0					100				μA
Reverse Recovery Time (Note 2)	t_{rr}	50					75				nS
Typical Junction Capacitance (Note 3)	C_j	20					15				pF
Operating Temperature Range	T_j	-65 to +125								$^{\circ}\text{C}$	
Storage Temperature Range	T_{STG}	-65 to +150								$^{\circ}\text{C}$	

*Glass passivated forms are available upon request

- Note: 1. Leads maintained at ambient temperature at a distance of 9.5mm from the case
 2. Measured with $I_F = 0.5\text{A}$, $I_R = 1.0\text{A}$, $IRR = 0.25\text{A}$. See figure 1.
 3. Measured at 1.0 MHz and applied reverse voltage of 4.0V D.C.

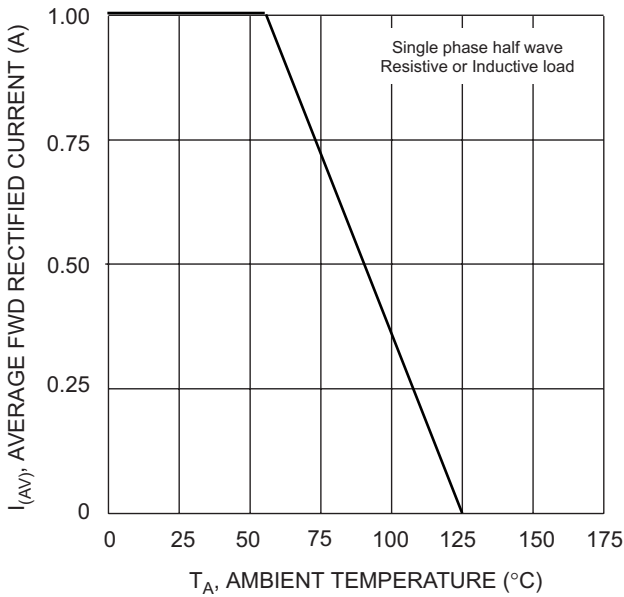

Fig. 1 Forward Current Derating Curve

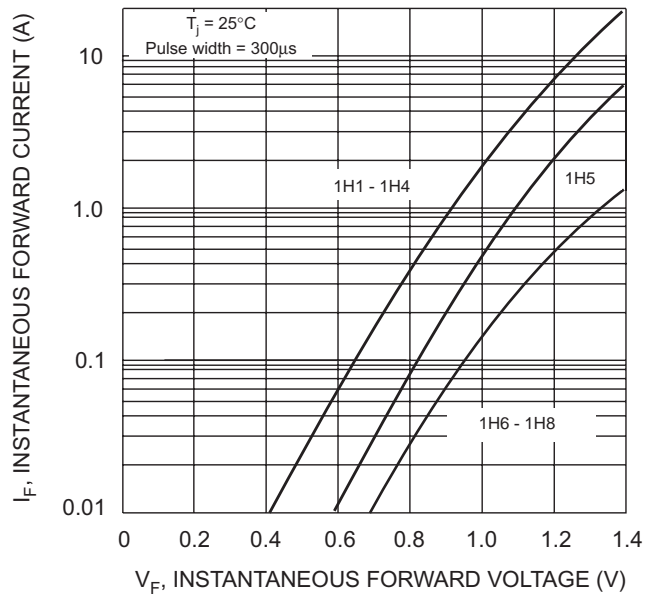

Fig. 2 Typical Forward Characteristics

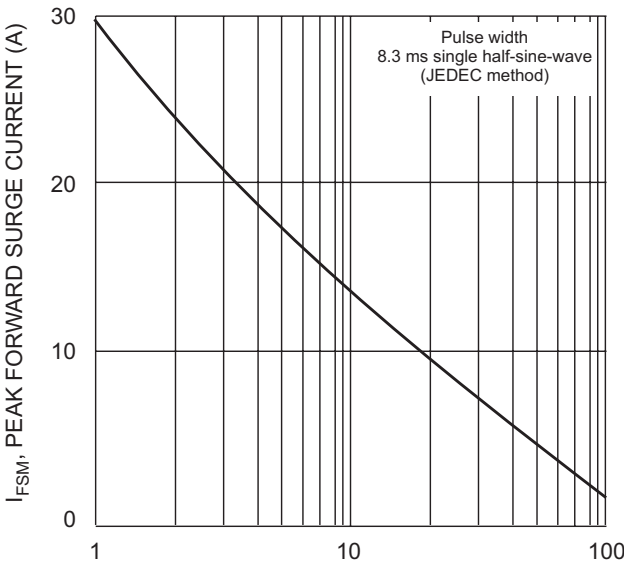

Fig. 3 Peak Forward Surge Current

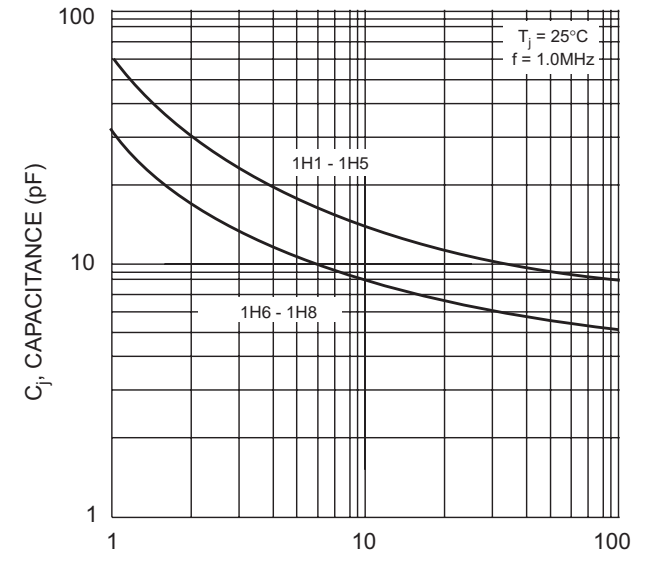
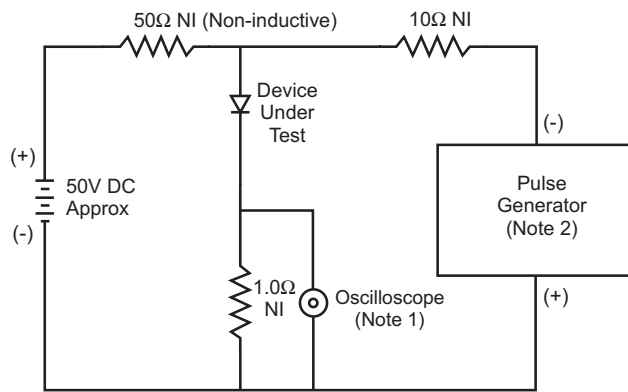

Fig. 4 Typical Junction Capacitance



- Notes:
1. Rise Time = 7.0ns max. Input Impedance = 1.0MΩ, 22pF.
 2. Rise Time = 10ns max. Input Impedance = 50Ω.

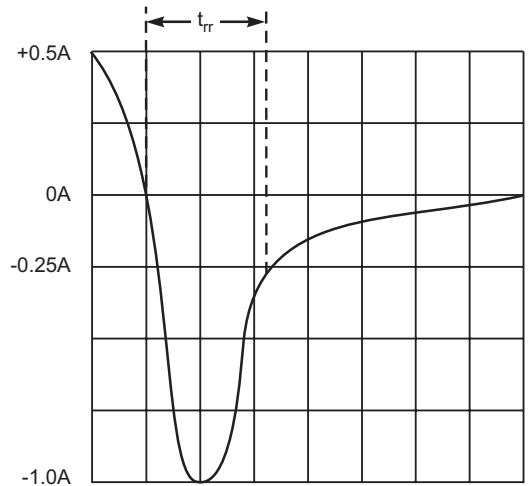

Fig. 5 Reverse Recovery Time Characteristic and Test Circuit

ORDERING INFORMATION

Product No.♦	Package Type	Shipping Quantity
1H1-T3	R-1	5000/Tape & Reel
1H1-TB	R-1	5000/Tape & Box
1H1	R-1	1000 Units/Box
1H2-T3	R-1	5000/Tape & Reel
1H2-TB	R-1	5000/Tape & Box
1H2	R-1	1000 Units/Box
1H3-T3	R-1	5000/Tape & Reel
1H3-TB	R-1	5000/Tape & Box
1H3	R-1	1000 Units/Box
1H4-T3	R-1	5000/Tape & Reel
1H4-TB	R-1	5000/Tape & Box
1H4	R-1	1000 Units/Box
1H5-T3	R-1	5000/Tape & Reel
1H5-TB	R-1	5000/Tape & Box
1H5	R-1	1000 Units/Box
1H6-T3	R-1	5000/Tape & Reel
1H6-TB	R-1	5000/Tape & Box
1H6	R-1	1000 Units/Box
1H7-T3	R-1	5000/Tape & Reel
1H7-TB	R-1	5000/Tape & Box
1H7	R-1	1000 Units/Box
1H8-T3	R-1	5000/Tape & Reel
1H8-TB	R-1	5000/Tape & Box
1H8	R-1	1000 Units/Box

Products listed in **bold** are WTE **Preferred** devices.

♦T3 suffix refers to a 13" reel. TB suffix refers to Ammo Pack.

Shipping quantity given is for minimum packing quantity only. For minimum order quantity, please consult the Sales Department.

Won-Top Electronics Co., Ltd (WTE) has checked all information carefully and believes it to be correct and accurate. However, WTE cannot assume any responsibility for inaccuracies. Furthermore, this information does not give the purchaser of semiconductor devices any license under patent rights to manufacturer. WTE reserves the right to change any or all information herein without further notice.

WARNING: DO NOT USE IN LIFE SUPPORT EQUIPMENT. WTE power semiconductor products are not authorized for use as critical components in life support devices or systems without the express written approval.

Won-Top Electronics Co., Ltd.

No. 44 Yu Kang North 3rd Road, Chine Chen Dist., Kaohsiung, Taiwan

Phone: 886-7-822-5408 or 886-7-822-5410

Fax: 886-7-822-5417

Email: sales@wontop.com

Internet: http://www.wontop.com

We power your everyday.