



Chokes and inductors

For high frequency and EMC
RF chokes, SBC series

Series/Type: B82141A / B82141B

Date: November 2005

RF chokes	B82141A
SBC series	B82141B

SBC choke (Small Bobbin Core)
Rated current 55 to 725 mA
Rated inductance 1 to 1000 μ H

Construction

- Mini ferrite drum core
- Winding: enamel copper wire
- Flame-retardant lacquer coating

Features

- Small size
- Relatively high rated current
- RoHS-compatible (see page 6)

Applications

- RF blocking and filtering
- Decoupling and interference suppression
- For electronic household appliances, automotive and entertainment electronics

Terminals

- Central axial leads, lead-free tinned
- Radially bent to 5 mm lead spacing

Marking

Inductance indicated by color bands to IEC 60062

Delivery mode

Taped, Ammo and reel packing (see page 8)

Dimensional drawings

B82141A (axial leads, taped)

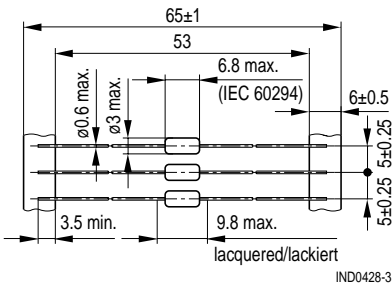

Minimum lead spacing 10 mm

Approx. weight 0.22 g

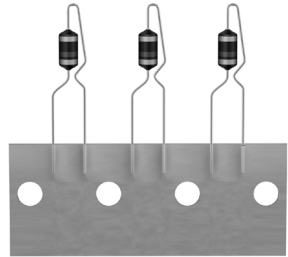
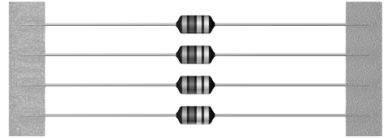

B82141B (central radial leads, taped)

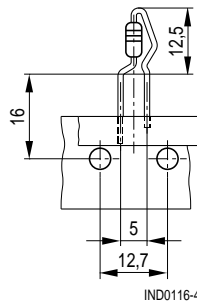

Schematic drawing (details page 8)

Characteristics and ordering codes

For further technical data see page 6.

L_R μH	Tolerance ¹⁾	Q_{min}	f_Q MHz	I_R mA	R_{max} Ω	$f_{res, min}$ MHz	Ordering code ²⁾ (reel packing) ³⁾
1.0	± 10 % △ K	40	7.96	725	0.19	180	B82141+1102K000
1.2		40	7.96	700	0.20	160	B82141+1122K000
1.5		40	7.96	670	0.22	155	B82141+1152K000
1.8		45	7.96	660	0.23	145	B82141+1182K000
2.2		45	7.96	630	0.25	130	B82141+1222K000
2.7		45	7.96	610	0.27	110	B82141+1272K000
3.3		50	7.96	580	0.30	90	B82141+1332K000
3.9		50	7.96	560	0.32	70	B82141+1392K000
4.7		50	7.96	530	0.36	60	B82141+1472K000
5.6		50	7.96	510	0.38	50	B82141+1562K000
6.8		50	7.96	480	0.43	40	B82141+1682K000
8.2		50	7.96	450	0.52	30	B82141+1822K000
10		55	2.52	410	0.60	25	B82141+1103K000
12		55	2.52	385	0.67	20	B82141+1123K000
15		55	2.52	365	0.74	17	B82141+1153K000
18	55	2.52	350	0.81	14	B82141+1183K000	
22	55	2.52	335	0.90	12	B82141+1223K000	
27	55	2.52	315	1.00	11	B82141+1273K000	
33	55	2.52	300	1.12	10	B82141+1333K000	
39	55	2.52	285	1.21	8.5	B82141+1393K000	

1) Closer tolerances upon request.

2) Replace the + by code letter »A« for axial taping or by »B« for radial taping.

3) For Ammo pack the last digit has to be a »9«. Example: B82141A1102K009.

Characteristics and ordering codes (continued)

For further technical data see page 5.

L_R μH	Tolerance ¹⁾	Q_{\min}	f_Q MHz	I_R mA	R_{\max} Ω	$f_{\text{res, min}}$ MHz	Ordering code ²⁾ (reel packing) ³⁾
47	$\pm 5\%$ $\triangleq J$	55	2.52	200	2.40	7.7	B82141+1473J000
56		55	2.52	195	2.60	6.8	B82141+1563J000
68		55	2.52	185	2.90	5.7	B82141+1683J000
82		55	2.52	175	3.20	5.5	B82141+1823J000
100		60	0.796	170	3.50	5.3	B82141+1104J000
120		60	0.796	160	3.80	5.0	B82141+1124J000
150		60	0.796	150	4.30	4.6	B82141+1154J000
180		60	0.796	135	5.30	4.2	B82141+1184J000
220		60	0.796	130	5.80	3.8	B82141+1224J000
270		60	0.796	115	7.80	3.2	B82141+1274J000
330		60	0.796	105	9.10	3.0	B82141+1334J000
390		60	0.796	95	11.0	2.7	B82141+1394J000
470		60	0.796	90	12.0	2.3	B82141+1474J000
560		60	0.796	75	16.5	2.2	B82141+1564J000
680		60	0.796	65	22.0	2.0	B82141+1684J000
820	60	0.796	60	25.0	1.8	B82141+1824J000	
1000	60	0.796	55	33.0	1.5	B82141+1105J000	

1) Closer tolerances upon request.

2) Replace the + by code letter »A« for axial tapping or by »B« for radial tapping.

3) For Ammo pack the last digit has to be a »9«. Example: B82141B1473J009.

Impedance $|Z|$
versus frequency f
measured with impedance analyzer
HP 4191A / HP 4194A

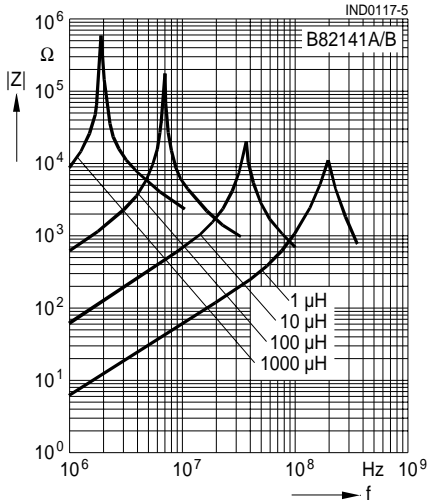

Inductance L
versus DC load current I_{DC}
measured with LCR meter
HP 4275A

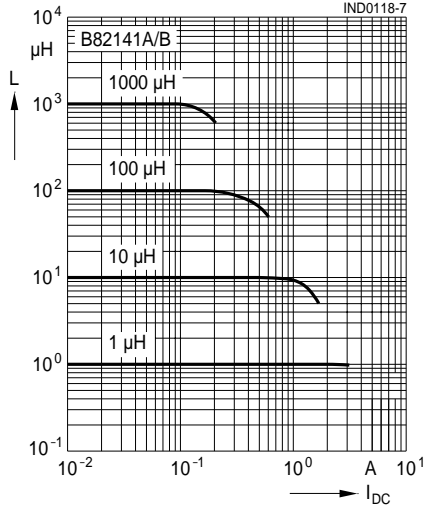

Q factor
versus frequency f
measured with impedance analyzer
HP 4194A

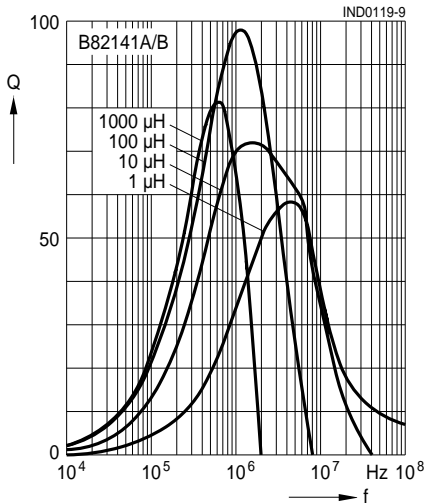

Current derating I_{op}/I_R
versus ambient temperature T_A
(rated temperature $T_R = 40^\circ\text{C}$)

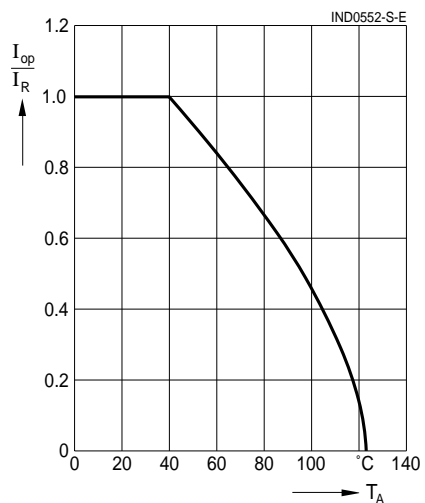

RF chokes	B82141A
SBC series	B82141B

General technical data

Rated inductance L_R	Measuring frequency: $L \leq 10 \mu\text{H}$ = 1 MHz $10 \mu\text{H} < L \leq 4700 \mu\text{H}$ = 100 kHz $L > 4700 \mu\text{H}$ = 10 kHz Measuring current: $\leq 1 \text{ mA}$ Distance between measuring clamps: 25.4 mm
Q factor Q_{\min}	Measured with HP 4342A
Rated current I_R	Maximum permissible DC current referred to 40 °C ambient temperature, for derating see below
Inductance decrease $\Delta L/L_0$	$\leq 10\%$ (referred to initial value) at I_R at 20 °C ambient temperature
DC resistance R_{\max}	Measured at 20 °C ambient temperature, distance between measuring clamps: 25.4 mm
Resonance frequency $f_{\text{res, min}}$	Measured with Scalar Network Analyzer ZAS from Rohde & Schwarz
Climatic category	55/125/56 (-55 °C/+125 °C/56 days damp heat test) to IEC 60068-1
Solderability	235 °C, 2 s, $\geq 90\%$ wetting to IEC 60068-2-20, test Ta
Resistance to soldering heat	To IEC 60068-2-20, test Tb 260 °C, 10 s
Tensile strength of leads	To IEC 60068-2-21, test Ua $\geq 20 \text{ N}$
RoHS-compatible	RoHS-compatible is defined as compatible with the following documents: DIRECTIVE 2002/95/EC OF THE EUROPEAN PARLIAMENT AND OF THE COUNCIL of 13 February 2003 on the restriction of the use of certain hazardous substances in electrical and electronic equipment COM (2004) 606 final Proposal for a COUNCIL DECISION amending Directive 2002/95/EC of the European Parliament and of the Council for the purposes of establishing the maximum concentration values for certain hazardous substances in electrical and electronic equipment.
 Mounting information	When bending the leads, take care that the start-of-winding areas at the face ends (protected by glue and lacquer) are not subjected to any mechanical stress.

Color coding of the inductance value

The inductance value and tolerance are encoded by means of colored bands in accordance with IEC 60062. The basic unit is μH .

- 1st band 1st digit of inductance value
- 2nd band 2nd digit of inductance value
- 3rd band multiplier, i.e. the power of ten, by which the first two digits have to be multiplied.
- 4th band tolerance of the inductance value.

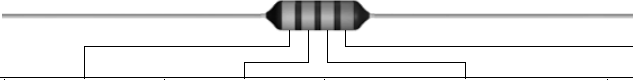

Color code	1 st band = 1 st digit	2 nd band = 2 nd digit	3 rd band = multiplier	4 th band = tolerance
Colorless	—	—	—	$\pm 20\%$ (M)
Silver	—	—	$\times 10^{-2} \mu\text{H} =$	$0.01 \mu\text{H}$ $\pm 10\%$ (K)
Gold	—	—	$\times 10^{-1} \mu\text{H} =$	$0.1 \mu\text{H}$ $\pm 5\%$ (J)
Black	—	0	$\times 10^0 \mu\text{H} =$	$1 \mu\text{H}$ —
Brown	1	1	$\times 10^1 \mu\text{H} =$	$10 \mu\text{H}$ —
Red	2	2	$\times 10^2 \mu\text{H} =$	$100 \mu\text{H}$ $\pm 2\%$ (G)
Orange	3	3	$\times 10^3 \mu\text{H} =$	$1000 \mu\text{H}$ —
Yellow	4	4	$\times 10^4 \mu\text{H} =$	$10000 \mu\text{H}$ —
Green	5	5	$\times 10^5 \mu\text{H} =$	$100000 \mu\text{H}$ —
Blue	6	6		Special designs manufactured to customer specifica- tions are identified by a white tolerance band.
Violet	7	7		
Grey	8	8		
White	9	9		

Examples:

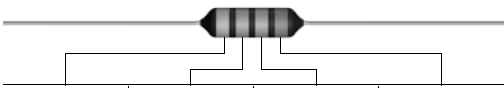

1 st band	2 nd band	3 rd band	4 th band	Decoding
Yellow 4	Violet 7	Gold $\times 0.1 \mu\text{H}$	Silver $\pm 10\%$	$= 47 \times 0.1 \mu\text{H} \pm 10\% = 4.7 \mu\text{H} \pm 10\%$
Brown 1	Green 5	Red $\times 100 \mu\text{H}$	Gold $\pm 5\%$	$= 15 \times 100 \mu\text{H} \pm 5\% = 1500 \mu\text{H} \pm 5\%$

Taping and packing

Axially taped (to IEC 60286-1)

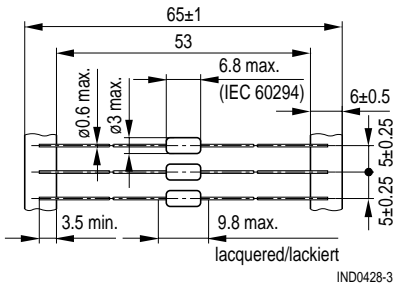

Radially taped (to IEC 60286-2)

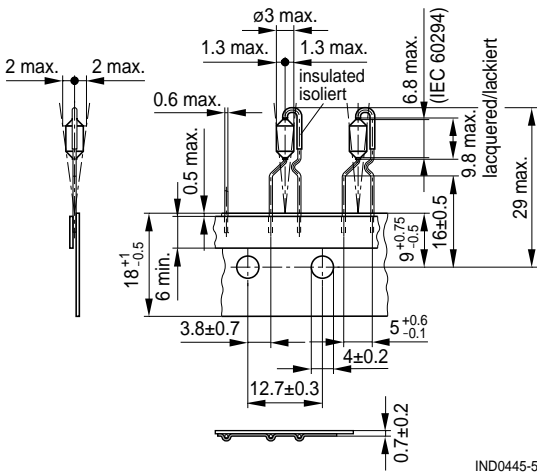

Reel packing

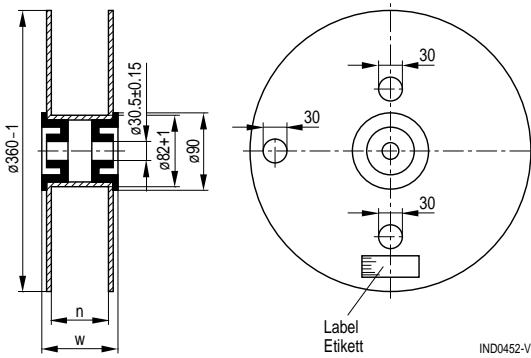

	Axial	Radial
n (mm)	72 +1	42 +1
w (mm)	84 max.	54 max.

Ammo pack

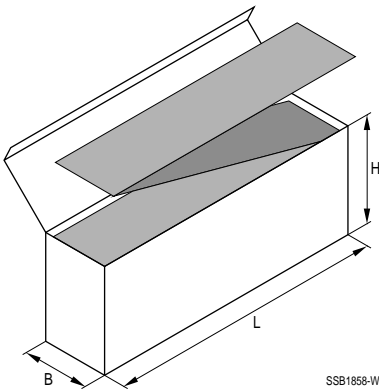

	Axial	Radial
L (mm)	310 max.	340 max.
B (mm)	75 max.	50 max.
H (mm)	120 max.	210 max.

Packing units

	Reel packing pcs./reel	Ammo pack pcs./pack.
Axial	5000	5000
Radial	2000	2500

Important notes

The following applies to all products named in this publication:

1. Some parts of this publication contain **statements about the suitability of our products for certain areas of application**. These statements are based on our knowledge of typical requirements that are often placed on our products in the areas of application concerned. We nevertheless expressly point out **that such statements cannot be regarded as binding statements about the suitability of our products for a particular customer application**.

As a rule, EPCOS is either unfamiliar with individual customer applications or less familiar with them than the customers themselves. For these reasons, it is always ultimately incumbent on the customer to check and decide whether an EPCOS product with the properties described in the product specification is suitable for use in a particular customer application.

2. We also point out that in **individual cases, a malfunction of passive electronic components or failure before the end of their usual service life cannot be completely ruled out in the current state of the art, even if they are operated as specified**. In customer applications requiring a very high level of operational safety and especially in customer applications in which the malfunction or failure of a passive electronic component could endanger human life or health (e.g. in accident prevention or life-saving systems), it must therefore be ensured by means of suitable design of the customer application or other action taken by the customer (e.g. installation of protective circuitry or redundancy) that no injury or damage is sustained by third parties in the event of malfunction or failure of a passive electronic component.

3. **The warnings, cautions and product-specific notes must be observed.**

4. In order to satisfy certain technical requirements, **some of the products described in this publication may contain substances subject to restrictions in certain jurisdictions (e.g. because they are classed as “hazardous”)**. Useful information on this will be found in our Material Data Sheets on the Internet (www.epcos.com/material). Should you have any more detailed questions, please contact our sales offices.

5. We constantly strive to improve our products. Consequently, **the products described in this publication may change from time to time**. The same is true of the corresponding product specifications. Please check therefore to what extent product descriptions and specifications contained in this publication are still applicable before or when you place an order.

We also **reserve the right to discontinue production and delivery of products**. Consequently, we cannot guarantee that all products named in this publication will always be available.

6. Unless otherwise agreed in individual contracts, **all orders are subject to the current version of the “General Terms of Delivery for Products and Services in the Electrical Industry” published by the German Electrical and Electronics Industry Association (ZVEI)**.

7. The trade names EPCOS, CeraDiode, CSSP, PhaseCap, PhaseMod, SilverCap, SIFI, SIMID, SIKOREL, SIOV, SIP5D, SIP5K, TOPcap, UltraCap, WindCap are **trademarks registered or pending** in Europe and in other countries. Further information will be found on the Internet at www.epcos.com/trademarks.