



L8561

LINEAR INTEGRATED CIRCUIT

POWER FACTOR CORRECTOR

DESCRIPTION

The UTC **L8561** is a Power Factor Corrector, which can work in wide input voltage range applications (from 85V ~ 265V) with an excellent THD. It has very low start up current (about 20 uA) and a disable function on the ZCD pin, which is designed to keep lower current consumption in stand by mode.

The device is operating in transition mode, and is able to drive a Power MOS or IGBT with a $\pm 400\text{mA}$ current for sourcing and sinking.

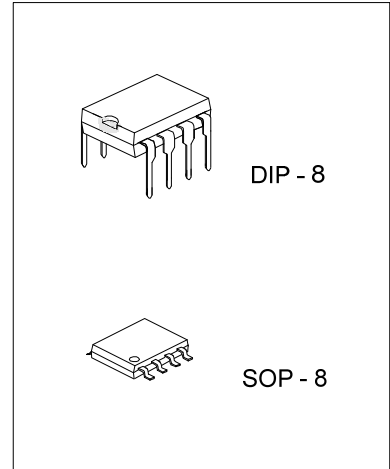

FEATURES

- * 1% Precision (@ $T_J = 25^\circ\text{C}$) Internal Reference Voltage
- * Output Overvoltage Protection
- * Very Low Power Start-Up Current
- * Current Sense Filter On Chip
- * Disable Function (with ZCD pin)
- * Transition Mode Operation
- * Gate Driving Current: $\pm 400\text{mA}$
- * 15V Gate clamped

ORDERING INFORMATION

Ordering Number		Package	Packing
Lead Free	Halogen Free		
L8561L-D08-T	L8561G-D08-T	DIP-8	Tube
L8561L-S08-R	L8561G-S08-R	SOP-8	Tape Reel
L8561L-S08-T	L8561G-S08-T	SOP-8	Tube

<p>L8561L-D08-T</p> <p>(1)Packing Type (2)Package Type (3)Lead Free</p>	<p>(1) R: Tape Reel, T: Tube (2) S08: SOP-8, D08: DIP-8 (3) G: Halogen Free, L: Lead Free</p>
---	---

■ PIN CONFIGURATION

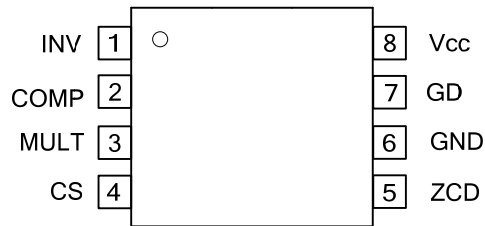

■ PIN DESCRIPTION

PIN NO	PIN NAME	DESCRIPTION
1	INV	Inverting input of the error amplifier.
2	COMP	Output of the error amplifier.
3	MULT	Input of the multiplier stage.
4	CS	Input of the current sense stage.
5	ZCD	Input of the zero current detection .
6	GND	Ground.
7	GD	Gate driver output.
8	V _{CC}	Voltage supply.

■ BLOCK DIAGRAM

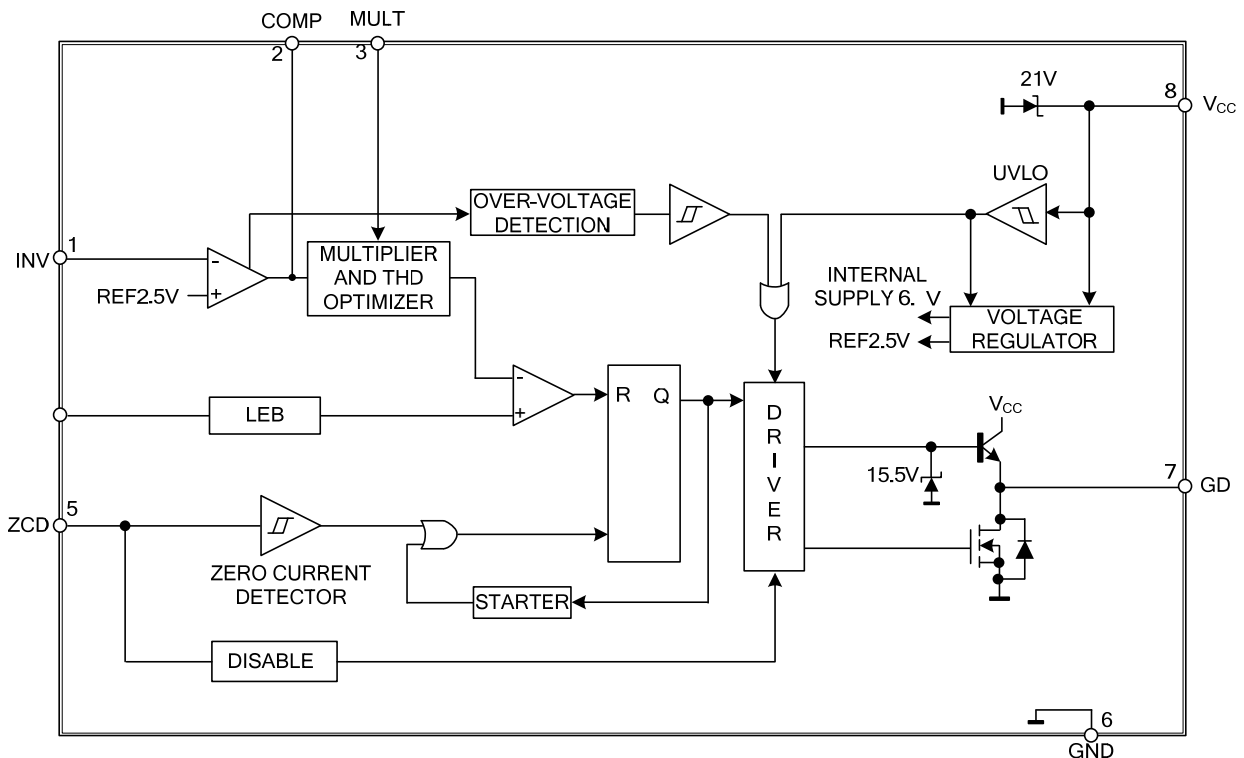

■ ABSOLUTE MAXIMUM RATING (T_A=25°C, unless otherwise specified)

PARAMETER	SYMBOL	RATINGS	UNIT
Analog Inputs & Outputs	INV, COMP MULT	-0.3 ~ 7	V
Current Sense Input	CS	-0.3 ~ 7	V
I _q +I _z (I _{GD} = 0)	I _{VCC}	30	mA
Output Totem Pole Peak Current (2ms)	I _{GD}	±700	mA
Zero Current Detector	ZCD	50 (source)	mA
		-10 (sink)	
Power Dissipation @ T _A =50°C	SOP-8	1	W
	DIP-8	0.65	W
Junction Temperature	T _J	125	°C
Operating Temperature	T _{OPR}	-20 ~ +85	°C
Storage Temperature	T _{STG}	-40 ~ +150	°C

Note: Absolute maximum ratings are those values beyond which the device could be permanently damaged.

Absolute maximum ratings are stress ratings only and functional device operation is not implied.

■ ELECTRICAL CHARACTERISTICS (T_A=-25°C ~ 125°C, V_{CC}=14.5V, unless otherwise specified)

PARAMETER	PIN	SYMBOL	TEST CONDITIONS	MIN	TYP	MAX	UNIT
SUPPLY VOLTAGE SECTION							
Operating Range	8	V _{CC}	after turn-on	11		18	V
Turn-on Threshold	8	V _{CC ON}		14	15.3	16.5	V
Turn-off Threshold	8	V _{CC OFF}		7.2	7.9	8.7	V
Hysteresis	8	Hys		6.5		8.3	V
SUPPLY CURRENT SECTION							
Start-up Current	8	I _{START-U}	V _{CC ON} -1V		30	50	μA
Quiescent Current	8	I _q			6	9	mA
Operating Supply Current	8	I _{CC}	C _L =1nF @ 70KHz		10	15	mA
			In OVP condition V _{pin1} =2.7V			6.8	mA
Quiescent Current	8	I _q	V _{PIN5} ≤150mV, V _{CC} >V _{CC off}			6	mA
	8		V _{PIN5} ≤150mV, V _{CC} <V _{CC off}	4	7	10	μA
Zener Voltage	8	V _Z	I _{CC} =20mA	18	21	24	V
ERROR AMPLIFIER SECTION							
Voltage Feedback Input Threshold	1	V _{INV}	T _A =25°C	2.465	2.5	2.535	V
			10.3V<V _{CC} <18V	2.44		2.56	V
Line Regulation			V _{CC} =10.3 ~ 18V		3	5	mV
Input Bias Current	1	I _{INV}			-100	-1000	uA
Voltage Gain		G _V	Open loop	60	80		dB
Gain Bandwidth		G _B			0.8		MHz
Source Current	2	I _{COMP}	V _{COMP} =4V, V _{INV} =2.4V	-2	-4	-8	mA
Sink Current			V _{COMP} =4V, V _{INV} =2.6V	2.5	4.5		mA
Upper Clamp Voltage	2	V _{COMP}	I _{SOURCE} =0.5mA	4.5	5	5.5	V
Lower Clamp Voltage			I _{SINK} =0.5mA	2.25	2.4	2.55	V
MULTIPLIER SECTION							
Linear Operating Voltage	3	V _{MULT}		0~ 2.5	0 ~ 3.5		V
Output Max. Slope		$\frac{\Delta V_{CS}}{\Delta V_{MULT}}$	V _{MULT} =from 0V ~ 0.5V	1.65	1.9		
			V _{COMP} =Upper ClamVoltage				
Gain		K	V _{MULT} =1V, V _{COMP} =4V	0.5	0.7	0.9	1/V

■ ELECTRICAL CHARACTERISTICS(Cont.)

PARAMETER	PIN	SYMBOL	TEST CONDITIONS	MIN	TYP	MAX	UNIT
CURRENT SENSE COMPARATOR							
Current Sense Reference Clamp	4	V_{CS}	$V_{MULT}=2.5V$ V_{COMP} =Upper Clamp Voltage	1.6	1.7	1.8	V
Input Bias Current	4	I_{CS}	$V_{OS}=0$		-0.05	-1	μA
Delay to Output	4	$T_{D(H-L)}$			200	450	ns
ZERO CURRENT DETECTOR							
Input Threshold Voltage Rising Edge	5	V_{ZCD}	(Note 1)		2.1		V
Hysteresis			(Note 1)	0.4	0.6	0.8	V
Upper Clamp Voltage	5	V_{ZCD}	$I_{ZCD}=20\mu A$	5.9	6.5	7.3	V
Upper Clamp Voltage	5	V_{ZCD}	$I_{ZCD}=3mA$	6.1	6.6	7.5	V
Lower Clamp Voltage	5	V_{ZCD}	$I_{ZCD}=3mA$	0.3	0.7	1	V
Sink Bias Current	5	I_{ZCD}	$1V \leq V_{ZCD} \leq 4.5V$		2		μA
Source Current Capability	5	I_{ZCD}		-3		-10	mA
Sink Current Capability	5	I_{ZCD}		3		10	mA
Disable threshold	5	V_{DIS}		100	200	300	mV
Restart Current After Disable	5	I_{ZCD}	$V_{ZCD} < V_{DIS}, V_{CC} > V_{COFF}$	-20	-50		μA
OUTPUT SECTION							
Dropout Voltage	7	V_{GD}	$I_{GD(SOURCR)}=200mA$		1.2	2	V
			$I_{GD(SOURCR)}=20mA$		0.8	1.2	V
			$I_{GD(SINK)}=200mA$		1.2	1.9	V
			$I_{GD(SINK)}=20mA$			1.2	V
Output Voltage Rise Time	7	t_R	$C_L=1nF$		40	100	ns
Output Voltage Fall Time	7	t_F	$C_L=1nF$		40	100	ns
IGD Sink Current	7	$I_{GD(OFF)}$	$V_{CC}=3.5V, V_{GD}=1V$	10	40		mA
OUTPUT OVERVOLTAGE SECTION							
OVP Triggering Current	2	I_{OVP}		30	40	50	μA
Static OVP Threshold				2.25	2.4	2.55	V
RESTART TIMER							
Start Timer		t_{START}		70	130	300	μs

Note: 1. Parameter guaranteed by design, not tested in production.

■ TYPICAL CHARACTERISTICS

Output ripple at 0.5W

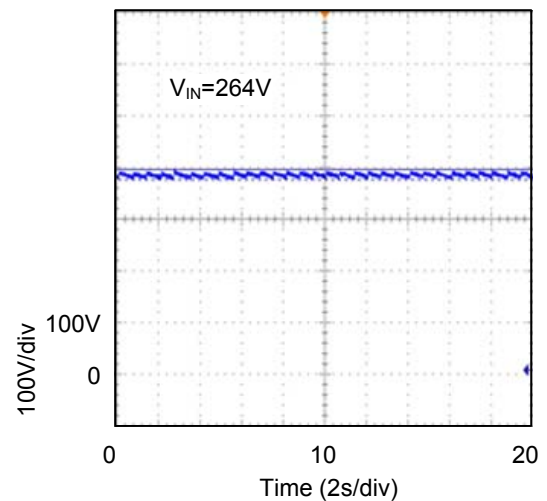
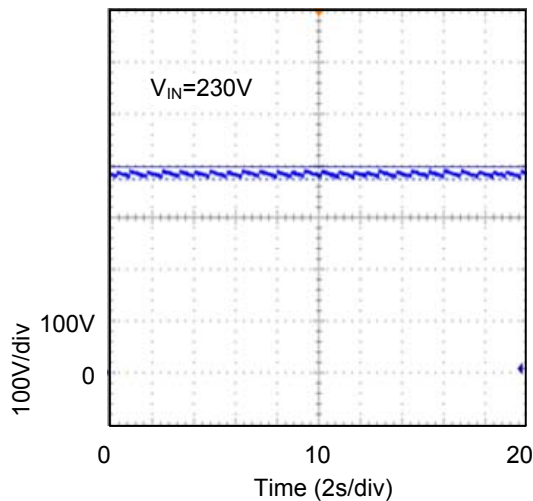
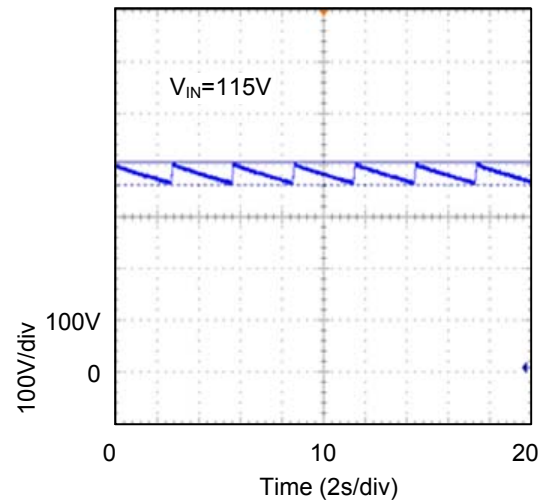
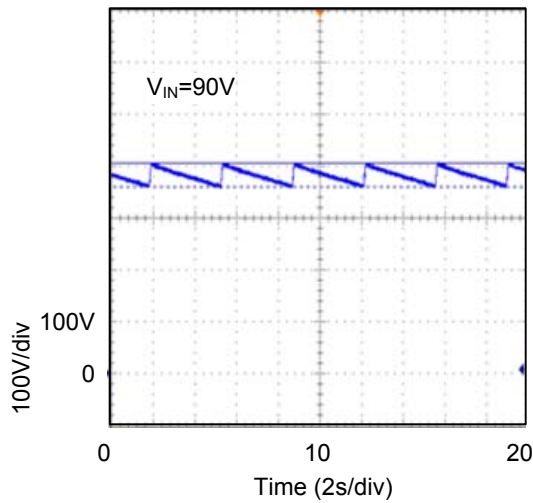

UTC assumes no responsibility for equipment failures that result from using products at values that exceed, even momentarily, rated values (such as maximum ratings, operating condition ranges, or other parameters) listed in products specifications of any and all UTC products described or contained herein. UTC products are not designed for use in life support appliances, devices or systems where malfunction of these products can be reasonably expected to result in personal injury. Reproduction in whole or in part is prohibited without the prior written consent of the copyright owner. The information presented in this document does not form part of any quotation or contract, is believed to be accurate and reliable and may be changed without notice.