

Low Power Ambient Light and Proximity Sensor with Intelligent Interrupt and Sleep Modes - Analog and Digital Out

ISL29030A

The ISL29030A is an integrated ambient and infrared light-to-digital converter with a built-in IR LED driver and I²C Interface (SMBus Compatible). This device uses two independent ADCs for concurrently measuring ambient light and proximity in parallel. The flexible interrupt scheme is designed for minimal microcontroller utilization.

For ambient light sensor (ALS) data conversions, an ADC converts photodiode current (with a light sensitivity range of 2000 lux) in 100ms per sample. The ADC rejects 50Hz/60Hz flicker noise caused by artificial light sources. The I_{ALS} pin provides an analog output current proportional to the measured light (420µA FSR).

For proximity sensor (Prox) data conversions, the built-in driver turns on an external infrared LED, and the proximity sensor ADC converts the reflected IR intensity to digital. This ADC rejects ambient IR noise (such as sunlight) and has a 540µs conversion time.

The ISL29030A provides low-power operation of the ALS and proximity sensing, with a typical 138µA normal operation current (110µA for sensors and internal circuitry; ~28µA for external LED, with 220mA current pulses for a net 100µs, repeating every 800ms or under).

The ISL29030A uses both a hardware pin and software bits to indicate an interrupt event has occurred. An ALS interrupt is defined as a measurement that is outside a set window. A proximity interrupt is defined as a measurement over a threshold limit. The user can configure the device so that ALS and proximity interrupts occur simultaneously, up to 16 times in a row, before the interrupt pin is activated.

The ISL29030A is designed to operate at 2.25V to 3.63V over the -40°C to +85°C ambient temperature range. It is packaged in a clear, lead-free 8 lead ODFN package.

Pin Configuration

ISL29030A
8 LD ODFN (2.0x2.1x0.7mm)
TOP VIEW

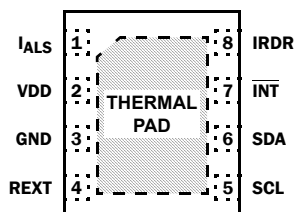

*THERMAL PAD CAN BE CONNECTED TO GND OR ELECTRICALLY ISOLATED

Features

- Works Under All Light Sources Including Sunlight
- Dual ADCs Measure ALS/Prox Concurrently
- Intelligent Interrupt Scheme Simplifies Microcontroller Code

Ambient Light Sensing

- Simple Output Code Directly Proportional to Lux
- 50Hz/60Hz Flicker Noise and IR Rejection
- Light Sensor Close to Human Eye Response
- Selectable 125/2000 Lux Range
- Analog 420µA Output Pin I_{ALS} Proportional to Lux

Proximity Sensing

- Proximity Sensor with Broad IR Spectrum
 - Can Use 850nm and 950nm External IR LEDs
- IR LED Driver with I²C Programmable Sink Currents
 - Net 100µs Pulse with 110mA or 220mA Amplitudes
 - Periodic Sleep Time Up to 800ms Between Pulses
- Ambient IR Noise Cancellation (Including Sunlight)

Intelligent and Flexible Interrupts

- Independent ALS/Prox Interrupt Thresholds
- Adjustable Interrupt Persistency
 - 1/4/8/16 Consecutive Triggers Required Before Interrupt

Ultra Low Power

- 138µA DC Typical Supply Current for ALS/Prox Sensing
 - 110µA for Sensors and Internal Circuitry
 - 28µA Typical Current for External IR LED (Assuming 220mA for 100µs Every 800ms)
- <1.0µA Supply Current When Powered Down

Easy to Use

- Set Registers; Wait for Interrupt
- I²C (SMBus Compatible) Output
- Temperature Compensated
- Tiny ODFN8 2.0x2.1x0.7 (mm) Package

Additional Features

- 1.7V to 3.63V Supply for I²C Interface
- 2.25V to 3.63V Sensor Power Supply
- Pb-Free (RoHS compliant)

Applications

- Display and Keypad Dimming Adjustment and Proximity Sensing for:
 - Mobile Devices: Smart Phone, PDA, GPS
 - Computing Devices: Laptop PC, Netbook
 - Consumer Devices: LCD-TV, Digital Picture Frame, Digital Camera
- Industrial and Medical Light and Proximity Sensing

ISL29030A

Pin Descriptions

PIN NUMBER	PIN NAME	DESCRIPTION	
0	T.PAD	Thermal pad (connect to GND or float)	
1	I _{ALS}	Analog current output (proportional to ALS/IR Data Count: 420µA FSR)	
2	VDD	Positive supply: 2.25V to 3.63V	
3	GND	Ground	
4	REXT	External resistor (499kΩ; 1%) connects this pin to ground	
5	SCL	I ² C clock line	The I ² C bus lines can be pulled from 1.7V to above V _{DD} ; 3.63V max
6	SDA	I ² C data line	
7	INT	Interrupt pin; logic output (open-drain) for interrupt	
8	IRDR	IR LED driver pin; current flows into ISL29030A from LED cathode	

Block Diagram

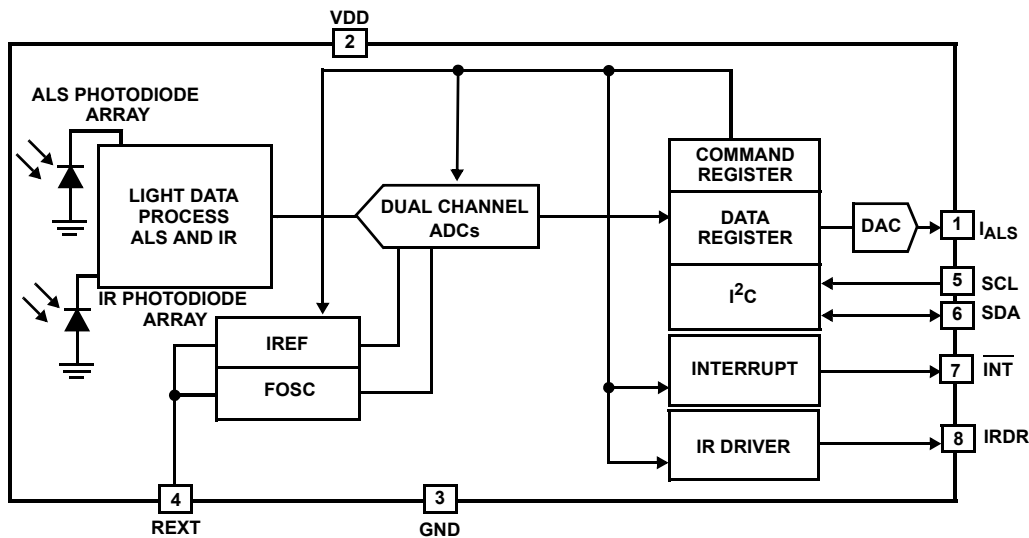

Ordering Information

PART NUMBER (Notes 1, 2, 3)	TEMP. RANGE (°C)	PACKAGE TAPE AND REEL (Pb-free)	PKG. DWG. #
ISL29030AIROZ-T7	-40 to +85	8 Ld ODFN	L8.2.1x2.0
ISL29030AIROZ-EVALZ	Evaluation Board		

NOTES:

1. Please refer to [TB347](#) for details on reel specifications.
2. These Intersil Pb-free plastic packaged products employ special Pb-free material sets; molding compounds/die attach materials and NiPdAu plate - e4 termination finish, which is RoHS compliant and compatible with both SnPb and Pb-free soldering operations. Intersil Pb-free products are MSL classified at Pb-free peak reflow temperatures that meet or exceed the Pb-free requirements of IPC/JEDEC J STD-020.
3. For Moisture Sensitivity Level (MSL), please see device information page for [ISL29030A](#). For more information on MSL please see techbrief [TB477](#).

ISL29030A

Absolute Maximum Ratings (T_A = +25°C)

V _{DD} Supply Voltage between V _{DD} and GND	4.0V
I ² C Bus Pin Voltage (SCL, SDA)	-0.5V to 4.0V
I ² C Bus Pin Current (SCL, SDA)	<10mA
R _{EXT} Pin Voltage	-0.5V to V _{DD} + 0.5V
IRDR Pin Voltage	5.5V
I _{ALS} Pin Voltage	-0.5V to V _{DD} + 0.5V
INT Pin Voltage	-0.5V to 4.0V
INT Pin Current	<10mA
ESD Rating	
Human Body Model (Note 5)	2kV

Thermal Information

Thermal Resistance (Typical, Note 4)	θ _{JA} (°C/W)
8 Ld ODFN	88
Maximum Die Temperature	+90°C
Storage Temperature	-40°C to +100°C
Operating Temperature	-40°C to +85°C
Pb-Free Reflow Profile	see link below http://www.intersil.com/pbfree/Pb-FreeReflow.asp

CAUTION: Do not operate at or near the maximum ratings listed for extended periods of time. Exposure to such conditions may adversely impact product reliability and result in failures not covered by warranty.

NOTES:

- θ_{JA} is measured in free air with the component mounted on a high effective thermal conductivity test board with “direct attach” features. See Tech Brief [TB379](#).
- ESD on all pins is 2kV, except for IRDR, which is 1.5kV.

Electrical Specifications V_{DD} = 3.0V, T_A = +25°C, R_{EXT} = 499kΩ 1% tolerance. Boldface limits apply over the operating temperature range, -40°C to +85°C.

PARAMETER	DESCRIPTION	CONDITION	MIN (Note 6)	TYP	MAX (Note 6)	UNIT
V _{DD}	Power Supply Range		2.25	3.0	3.63	V
SR_V _{DD}	Input Power-up Slew Rate	V _{DD} Rising Edge between 0.4V and 2.25V	0.5			V/ms
I _{DD_OFF}	Supply Current when Powered Down	ALS_EN = 0; PROX_EN = 0		0.1	0.8	μA
I _{DD_NORM}	Supply Current for ALS+Prox in Sleep Time	ALS_EN = 1; PROX_EN = 1		116	135	μA
I _{DD_PRX_SLP}	Supply Current for Prox in Sleep Time	ALS_EN = 0; PROX_EN = 1		85		μA
I _{DD_ALS}	Supply Current for ALS	ALS_EN = 1; PROX_EN = 0		102		μA
f _{OSC}	Internal Oscillator Frequency			5.25		MHz
t _{INTGR_ALS}	12-bit ALS Integration/Conversion Time		88	100	112	ms
t _{INTGR_PROX}	8-bit Prox Integration/Conversion Time			0.54		ms
I _{ALS_OFF}	I _{ALS} Output Current when ALS = Disabled	ALS_EN = 0; V _{I_ALS} = 0V		3	100	nA
I _{ALS_0}	I _{ALS} Output Current When Dark	ALS_EN = 1; ALS_RANGE = 1; E = 0 lux		0.1	0.6	μA
I _{ALS_1}	Current Output under Specified Conditions	E = 53 lux, Fluorescent (Note 7), ALS_RANGE = 0		161		μA
I _{ALS_2}	Current Output under Specified Conditions	E = 320 lux, Fluorescent (Note 7) ALS_RANGE = 1	40	60	80	μA
I _{ALS_F}	I _{ALS} Output Current At Full Scale	ALS_EN = 1; ALS Code = 4095	380	420	460	μA
V _{I_ALS}	Compliance Voltage on I _{ALS} w/ 5% Variation in Output Current	ALS_EN = 1; ALS Code = 4095	0		VDD-0.8	V
DATA _{ALS_0}	ALS Result when Dark	E _{AMBIENT} = 0 lux, 2k Range		1	3	Counts
DATA _{ALS_F}	Full Scale ALS ADC Code	E _{AMBIENT} > Selected Range Maximum lux (Note 10)			4095	Counts
$\frac{\Delta \text{DATA}}{\text{DATA}}$	Count Output Variation Over Three Light Sources: Fluorescent, Incandescent and Sunlight	Ambient Light Sensing		±10		%
DATA _{ALS_1}	Light Count Output with LSB of 0.0326 lux/count	E = 53 lux, Fluorescent (Notes 7, 10), ALS_RANGE = 0		1638		Counts
DATA _{ALS_2}	Light Count Output With LSB of 0.522 lux/count	E = 320 lux, Fluorescent (Note 7) ALS_RANGE = 1	460	614	768	Counts

ISL29030A

Electrical Specifications $V_{DD} = 3.0V$, $T_A = +25^\circ C$, $R_{EXT} = 499k\Omega$ 1% tolerance. **Boldface limits apply over the operating temperature range, $-40^\circ C$ to $+85^\circ C$.** (Continued)

PARAMETER	DESCRIPTION	CONDITION	MIN (Note 6)	TYP	MAX (Note 6)	UNIT
DATA _{PROX_0}	Prox Measurement w/o Object in Path			1	2	Counts
DATA _{PROX_F}	Full Scale Prox ADC Code				255	Counts
DATA _{PROX_1}	Prox Measurement Result	(Note 8)	35	46	57	Counts
t_r	Rise Time for IRDR Sink Current	$R_{LOAD} = 15\Omega$ at IRDR pin, 20% to 80%		500		ns
t_f	Fall time for IRDR Sink Current	$R_{LOAD} = 15\Omega$ at IRDR pin, 80% to 20%		500		ns
I_{IRDR_0}	IRDR Sink Current	PROX_DR = 0; $V_{IRDR} = 0.5V$	98	110	120	mA
I_{IRDR_1}	IRDR Sink Current	PROX_DR = 1; $V_{IRDR} = 0.5V$		220		mA
I_{IRDR_LEAK}	IRDR Leakage Current	PROX_EN = 0; $V_{DD} = 3.63V$ (Note 9)	-1	0.001	1	μA
V_{IRDR}	Acceptable Voltage Range on IRDR Pin	Register bit PROX_DR = 0	0.5		4.3	V
t_{PULSE}	Net I_{IRDR} On Time Per PROX Reading			100		μs
V_{REF}	Voltage of R_{EXT} Pin			0.51		V
F_{I^2C}	I^2C Clock Rate Range				400	kHz
V_{I^2C}	Supply Voltage Range for I^2C Interface		1.7		3.63	V
V_{IL}	SCL and SDA Input Low Voltage				0.55	V
V_{IH}	SCL and SDA Input High Voltage		1.25			V
I_{SDA}	SDA Current Sinking Capability	$V_{OL} = 0.4V$	3	5		mA
I_{INT}	\overline{INT} Current Sinking Capability	$V_{OL} = 0.4V$	3	5		mA
PSRR _{IRDR}	$(\Delta I_{IRDR}) / (\Delta V_{IRDR})$	PROX_DR = 0; $V_{IRDR} = 0.5V$ to $4.3V$		4		mA/V

NOTES:

- Compliance to datasheet limits is assured by one or more methods: production test, characterization and/or design.
- An LED is used in production test. The LED irradiance is calibrated to produce the same DATA count against a fluorescent light source of the same lux level.
- An 850nm infrared LED is used to test PROX/IR sensitivity in an internal test mode.
- Ability to guarantee I_{IRDR} leakage of $\sim 1nA$ is limited by test hardware.
- For ALS applications under light-distorting glass, please see "ALS Range 1 Considerations" on page 10.

I^2C Electrical Specifications For SCL and SDA unless otherwise noted, $V_{DD} = 3V$, $T_A = +25^\circ C$, $R_{EXT} = 499k\Omega$ 1% tolerance (Note 11). **Boldface limits apply over the operating temperature range, $-40^\circ C$ to $+85^\circ C$.**

PARAMETER	DESCRIPTION	CONDITION	MIN	TYP	MAX	UNIT
V_{I^2C}	Supply Voltage Range for I^2C Interface		1.7		3.63	V
f_{SCL}	SCL Clock Frequency				400	kHz
V_{IL}	SCL and SDA Input Low Voltage				0.55	V
V_{IH}	SCL and SDA Input High Voltage		1.25			V
V_{hys}	Hysteresis of Schmitt Trigger Input		0.05 V_{DD}			V
V_{OL}	Low-level Output Voltage (Open-drain) at 4mA Sink Current				0.4	V
I_i	Input Leakage for each SDA, SCL Pin		-10		10	μA
t_{SP}	Pulse Width of Spikes that must be Suppressed by the Input Filter				50	ns
t_{AA}	SCL Falling Edge to SDA Output Data Valid				900	ns
C_i	Capacitance for each SDA and SCL Pin				10	pF

ISL29030A

I²C Electrical Specifications For SCL and SDA unless otherwise noted, $V_{DD} = 3V$, $T_A = +25^\circ C$, $R_{EXT} = 499k\Omega$ 1% tolerance (Note 11). **Boldface limits apply over the operating temperature range, $-40^\circ C$ to $+85^\circ C$.** (Continued)

PARAMETER	DESCRIPTION	CONDITION	MIN	TYP	MAX	UNIT
$t_{HD:STA}$	Hold Time (Repeated) START Condition	After this period, the first clock pulse is generated	600			ns
t_{LOW}	LOW Period of the SCL Clock	Measured at the 30% of V_{DD} crossing	1300			ns
t_{HIGH}	HIGH period of the SCL Clock		600			ns
$t_{SU:STA}$	Set-up Time for a Repeated START Condition		600			ns
$t_{HD:DAT}$	Data Hold Time		30			ns
$t_{SU:DAT}$	Data Set-up Time		100			ns
t_R	Rise Time of both SDA and SCL Signals	(Note 12)	20 + 0.1xC_b			ns
t_F	Fall Time of both SDA and SCL Signals	(Note 12)	20 + 0.1xC_b			ns
$t_{SU:STO}$	Set-up Time for STOP Condition		600			ns
t_{BUF}	Bus Free Time Between a STOP and START Condition		1300			ns
C_b	Capacitive Load for Each Bus Line				400	pF
$R_{pull-up}$	SDA and SCL system bus pull-up resistor	Maximum is determined by t_R and t_F	1			k Ω
$t_{VD:DAT}$	Data Valid Time				0.9	μs
$t_{VD:ACK}$	Data Valid Acknowledge Time				0.9	μs
V_{nL}	Noise Margin at the LOW Level		0.1V_{DD}			V
V_{nH}	Noise Margin at the HIGH Level		0.2V_{DD}			V

NOTES:

- 11. I²C limits are based on design/simulation and are not production tested.
- 12. C_b is the capacitance of the bus in pF.

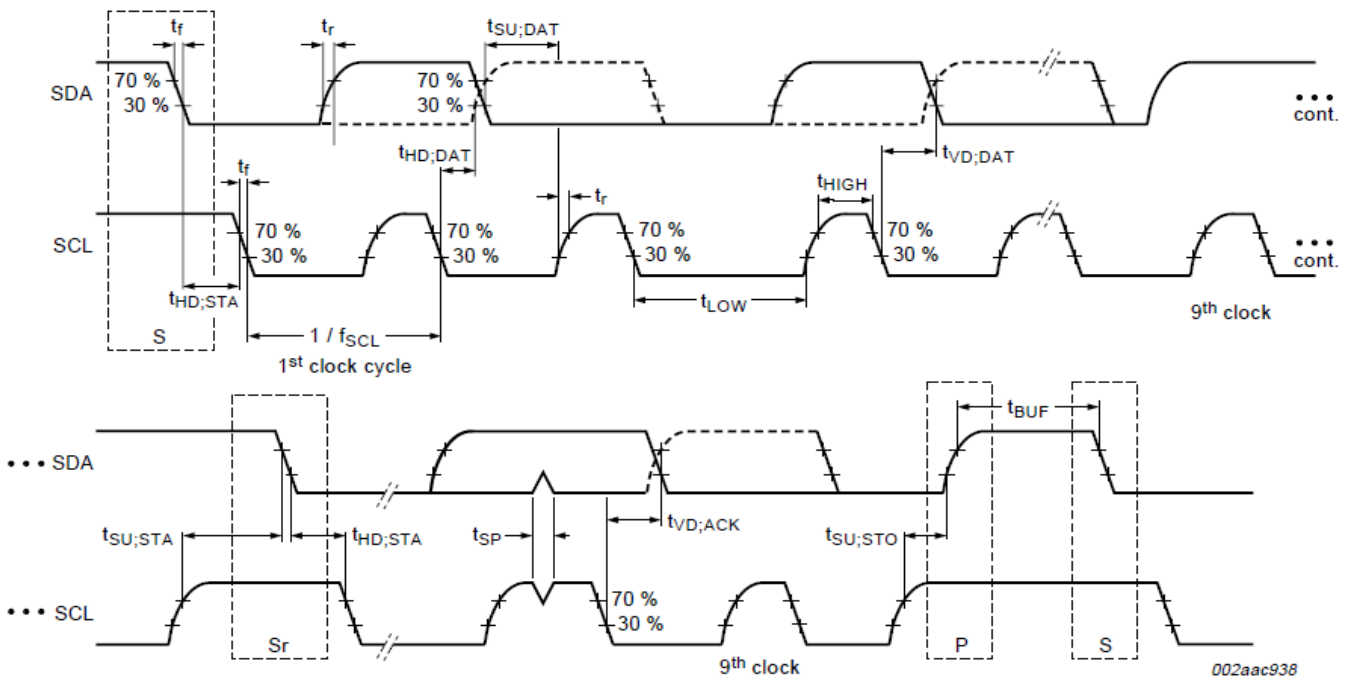

FIGURE 1. I²C TIMING DIAGRAM

ISL29030A

Register Map

There are ten 8-bit registers accessible via I²C. Registers 0x1 and 0x2 define the operation mode of the device. Registers 0x3 through 0x7 store the various ALS/IR/Prox thresholds which trigger interrupt events. Registers 0x8 through 0xA store the results of ALS/IR/Prox ADC conversions.

TABLE 1. ISL29030A REGISTERS AND REGISTER BITS

ADDR	REG NAME	BIT								DEFAULT
		7	6	5	4	3	2	1	0	
0x00	(n/a)	(Reserved)								(n/a)
0x01	CONFIGURE	PROX_EN	PROX_SLP[2:0]		PROX_DR	ALS_EN	ALS_RANGE	ALSIR_MODE		0x00
0x02	INTERRUPT	PROX_FLAG	PROX_PRST[1:0]		(Write 0)	ALS_FLAG	ALS_PRST[1:0]		INT_CTRL	0x00
0x03	PROX_LT	PROX_LT[7:0]								0x00
0x04	PROX_HT	PROX_HT[7:0]								0xFF
0x05	ALSIR_TH1	ALSIR_LT[7:0]								0x00
0x06	ALSIR_TH2	ALSIR_HT[3:0]				ALSIR_LT[11:8]				0xF0
0x07	ALSIR_TH3	ALSIR_HT[11:4]								0xFF
0x08	PROX_DATA	PROX_DATA[7:0]								0x00
0x09	ALSIR_DT1	ALSIR_DATA[7:0]								0x00
0x0A	ALSIR_DT2	(Unused)				ALSIR_DATA[11:8]				0x00
0x0E	TEST1	(Write as 0x00)								0x00
0x0F	TEST2	(Write as 0x00)								0x00

Register Descriptions

TABLE 2. REGISTER 0x00 (RESERVED)

BIT #	ACCESS	DEFAULT	NAME	FUNCTION/OPERATION
7:0	(n/a)	(n/a)	(n/a)	Reserved - no need to read or write

TABLE 3. REGISTER 0x01 (CONFIGURE) - PROX/ALS CONFIGURATION

BIT #	ACCESS	DEFAULT	NAME	FUNCTION/OPERATION
7	RW	0x00	PROX_EN (Prox Enable)	When = 0, proximity sensing is disabled When = 1, continuous proximity sensing is enabled. Prox data will be ready 0.54ms after this bit is set high
6:4	RW	0x00	PROX_SLP (Prox Sleep)	For bits 6:4 = (see the following) 111; sleep time between prox IR LED pulses is 0.0ms (run continuously) 110; sleep time between prox IR LED pulses is 12.5ms 101; sleep time between prox IR LED pulses is 50ms 100; sleep time between prox IR LED pulses is 75ms 011; sleep time between prox IR LED pulses is 100ms 010; sleep time between prox IR LED pulses is 200ms 001; sleep time between prox IR LED pulses is 400ms 000; sleep time between prox IR LED pulses is 800ms
3	RW	0x00	PROX_DR (Prox Drive)	When = 0, IRDR behaves as a pulsed 110mA current sink When = 1, IRDR behaves as a pulsed 220mA current sink
2	RW	0x00	ALS_EN (ALS Enable)	When = 0, ALS/IR sensing is disabled When = 1, continuous ALS/IR sensing is enabled with new data ready every 100ms
1	RW	0x00	ALS_RANGE (ALS Range)	When = 0, ALS is in low-lux range When = 1, ALS is in high-lux range
0	RW	0x00	ALSIR_MODE (ALSIR Mode)	When = 0, ALS/IR data register contains visible ALS sensing data When = 1, ALS/IR data register contains IR spectrum sensing data

ISL29030A

TABLE 4. REGISTER 0x02 (INTERRUPT) - PROX/ALS INTERRUPT CONTROL

BIT #	ACCESS	DEFAULT	BIT NAME	FUNCTION/OPERATION
7	FLAG	0x00	PROX_FLAG (Prox Flag)	When = 0, no Prox interrupt event has occurred since power-on or last "clear" When = 1, a Prox interrupt event occurred. Clearable by writing "0"
6:5	RW	0x00	PROX_PRST (Prox Persist)	For bits 6:5 = (see the following) 00; set PROX_FLAG if 1 conversion result trips the threshold value 01; set PROX_FLAG if 4 conversion results trip the threshold value 10; set PROX_FLAG if 8 conversion results trip the threshold value 11; set PROX_FLAG if 16 conversion results trip the threshold value
4	RW	0x00	Unused (Write 0)	Unused register bit - write 0
3	FLAG	0x00	ALS_FLAG (ALS FLAG)	When = 0, no ALS interrupt event has occurred since power-on or last "clear" When = 1, an ALS interrupt event occurred. Clearable by writing "0"
2:1	RW	0x00	ALS_PRST (ALS Persist)	For bits 2:1 = (see the following) 00; set ALS_FLAG if 1 conversion is outside the set window 01; set ALS_FLAG if 4 conversions are outside the set window 10; set ALS_FLAG if 8 conversions are outside the set window 11; set ALS_FLAG if 16 conversions are outside the set window
0	RW	0x00	INT_CTRL (Interrupt Control)	When = 0, set $\overline{\text{INT}}$ pin low if PROX_FLAG or ALS_FLAG high (logical OR) When = 1, set $\overline{\text{INT}}$ pin low if PROX_FLAG and ALS_FLAG high (logical AND)

TABLE 5. REGISTER 0x03 (PROX_LT) - INTERRUPT LOW THRESHOLD FOR PROXIMITY SENSOR

BIT #	ACCESS	DEFAULT	BIT NAME	FUNCTION/OPERATION
7:0	RW	0x00	PROX_LT (Prox Threshold)	8-bit interrupt low threshold for proximity sensing

TABLE 6. REGISTER 0x04 (PROX_HT) - INTERRUPT HIGH THRESHOLD FOR PROXIMITY SENSOR

BIT #	ACCESS	DEFAULT	BIT NAME	FUNCTION/OPERATION
7:0	RW	0xFF	PROX_HT (Prox Threshold)	8-bit interrupt high threshold for proximity sensing

TABLE 7. REGISTER 0x05 (ALSIR_TH1) - INTERRUPT LOW THRESHOLD FOR ALS/IR

BIT #	ACCESS	DEFAULT	BIT NAME	FUNCTION/OPERATION
7:0	RW	0x00	ALSIR_LT[7:0] (ALS/IR Low Thr.)	Lower 8 bits (of 12 bits) for ALS/IR low interrupt threshold

TABLE 8. REGISTER 0x06 (ALSIR_TH2) - INTERRUPT LOW/HIGH THRESHOLDS FOR ALS/IR

BIT #	ACCESS	DEFAULT	BIT NAME	FUNCTION/OPERATION
7:4	RW	0x0F	ALSIR_HT[3:0] (ALS/IR High Thr.)	Lower 4 bits (of 12 bits) for ALS/IR high interrupt threshold
3:0	RW	0x00	ALSIR_LT[11:8] (ALS/IR Low Thr.)	Upper 4 bits (of 12 bits) for ALS/IR low interrupt threshold

TABLE 9. REGISTER 0x07 (ALSIR_TH3) - INTERRUPT HIGH THRESHOLD FOR ALS/IR

BIT #	ACCESS	DEFAULT	BIT NAME	FUNCTION/OPERATION
7:0	RW	0xFF	ALSIR_HT[11:4] (ALS/IR High Thr.)	Upper 8 bits (of 12 bits) for ALS/IR high interrupt threshold

ISL29030A

TABLE 10. REGISTER 0x08 (PROX_DATA) - PROXIMITY SENSOR DATA

BIT #	ACCESS	DEFAULT	BIT NAME	FUNCTION/OPERATION
7:0	RO	0x00	PROX_DATA (Proximity Data)	Results of 8-bit proximity sensor ADC conversion

TABLE 11. REGISTER 0x09 (ALSIR_DT1) - ALS/IR SENSOR DATA (LOWER 8 BITS)

BIT #	ACCESS	DEFAULT	BIT NAME	FUNCTION/OPERATION
7:0	RO	0x00	ALSIR_DATA (ALS/IR Data)	Lower 8 bits (of 12 bits) from result of ALS/IR sensor conversion

TABLE 12. REGISTER 0x0A (ALSIR_DT2) - ALS/IR SENSOR DATA (UPPER 4 BITS)

BIT #	ACCESS	DEFAULT	BIT NAME	FUNCTION/OPERATION
7:4	RO	0x00	(Unused)	Unused bits.
3:0	RO	0x00	ALSIR_DATA (ALS/IR Data)	Upper 4 bits (of 12 bits) from result of ALS/IR sensor conversion

TABLE 13. REGISTER 0x0E (TEST1) - TEST MODE

BIT #	ACCESS	DEFAULT	BIT NAME	FUNCTION/OPERATION
7:0	RW	0x00	(Write as 0x00)	Test mode register. When 0x00, in normal operation.

TABLE 14. REGISTER 0x0F (TEST2) - TEST MODE 2

BIT #	ACCESS	DEFAULT	BIT NAME	FUNCTION/OPERATION
7:0	RW	0x00	(Write as 0x00)	Test mode register. When 0x00, in normal operation.

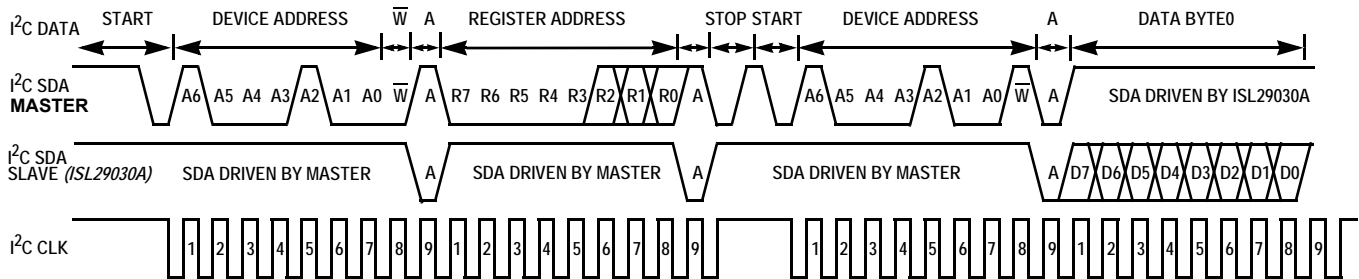

FIGURE 2. I²C DRIVER TIMING DIAGRAM FOR MASTER AND SLAVE CONNECTED TO COMMON BUS

Principles of Operation

I²C Interface

The ISL29030A I²C interface slave address is internally hardwired as 0b1000100.

Figure 2 shows a sample one-byte read. The I²C bus master always drives the SCL (clock) line, while either the master or the slave can drive the SDA (data) line. Every I²C transaction begins with the master asserting a start condition (SDA falling while SCL remains high). The first transmitted byte is initiated by the master and includes seven address bits and a R/W bit. The slave is responsible for pulling SDA low during the ACK bit after every transmitted byte.

Each I²C transaction ends with the master asserting a stop condition (SDA rising while SCL remains high).

For more information about the I²C standard, please consult the Philips™ I²C specification documents.

Photodiodes and ADCs

The ISL29030A contains two photodiode arrays that convert photons (light) into current. The ALS photodiodes are constructed to mimic the human eye wavelength response curve to visible light (see Figure 7). The ALS photodiode current output is digitized by a 12-bit ADC in 100ms. These 12 bits can be accessed by reading from I²C registers 0x9 and 0xA when the ADC conversion is completed.

The ALS converter is a charge-balancing, integrating, 12-bit ADC. Charge-balancing is best for converting small current signals in the presence of periodic AC noise. Integrating over 100ms highly rejects both 50Hz and 60Hz light flicker by picking the lowest-integer number of cycles for both 50Hz/60Hz frequencies.

The proximity sensor is an 8-bit ADC that operates in a similar fashion. When proximity sensing is enabled, the IRDR pin drives a user-supplied infrared LED, the emitted IR reflects off an object (i.e., a human head) back into the ISL29030A, and a sensor

converts the reflected IR wave to a current signal in 0.54ms. The ADC subtracts the IR reading before and after the LED is driven (to remove ambient IR such as sunlight) and converts this value to a digital count stored in Register 0x8.

The ISL29030A is designed to run two conversions concurrently: a proximity conversion, and an ALS (or IR) conversion. Please note that because of the conversion times, the user must let the ADCs perform one full conversion first before reading from I²C Registers PROX_DATA (wait 0.54ms) or ALSIR_DT1/2 (wait 100ms). The timing between ALS and Prox conversions is arbitrary, as shown in Figure 3. The ALS runs continuously, with new data available every 100ms. The proximity sensor runs continuously, with a time between conversions decided by PROX_SLP (Register 1 Bits [6:4]).

Ambient Light and IR Sensing

The ISL29030A is set for ambient light sensing when Register bit ALSIR_MODE = 0 and ALR_EN = 1. The light-wavelength response of the ALS appears as shown in Figure 6. ALS measuring mode (as opposed to IR measuring mode) is set by default.

When the part is programmed for infrared (IR) sensing (ALSIR_MODE = 1; ALS_EN = 1), infrared light is converted into a current and is digitized by the same ALS ADC. The result of an IR conversion is *strongly related* to the amount of IR energy incident on the sensor, but it is unitless and is referred to in digital counts.

Proximity Sensing

When proximity sensing is enabled (PROX_EN = 1), the external IR LED is driven through the IRDR pin for 0.1ms by the built-in IR LED driver. The amplitude of the IR LED current depends on Register 1 bit 3: PROX_DR. If this bit is low, the load sees a fixed 110mA current pulse. If this bit is high, the load on IRDR sees a fixed 220mA current pulse, as shown in Figure 4.

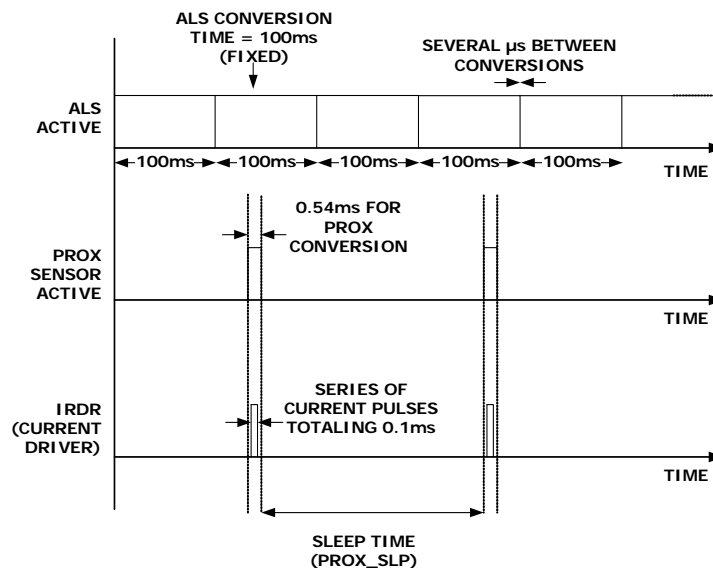

FIGURE 3. TIMING DIAGRAM FOR PROX/ALS EVENTS - NOT TO SCALE

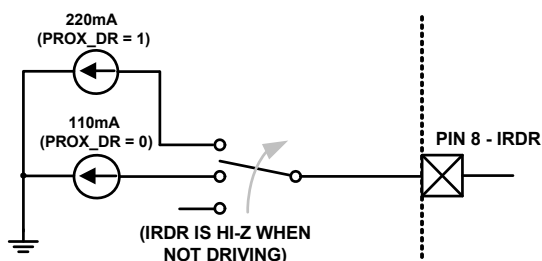

FIGURE 4. CURRENT DRIVE MODE OPTIONS

When the IR from the LED reaches an object and gets reflected back into the ISL29030A, the reflected IR light is converted into current, as shown by the IR spectral response in Figure 7. One entire proximity measurement takes 0.54ms for one conversion (which includes 0.1ms spent driving the LED), and the period *between* proximity measurements is decided by PROX_SLP (sleep time) in Register 1 Bits 6:4.

Average LED driving current consumption is given by Equation 1.

$$I_{\text{IRDR(AVG)}} = \frac{I_{\text{IRDR(PEAK)}} \times 100\mu\text{s}}{T_{\text{SLEEP}} + 540\mu\text{s}} \quad (\text{EQ. 1})$$

A typical IRDR scheme is 220mA amplitude pulses every 800ms, which yields 28μA DC.

Total Current Consumption

Total current consumption is the sum of I_{DD} and I_{IRDR} . The IRDR pin sinks current (as shown in Figure 4), and the average IRDR current can be calculated using Equation 1. I_{DD} depends on voltage and the mode of operation, as shown in Figure 11.

Interrupt Function

The ISL29030A has an intelligent interrupt scheme designed to shift some logic processing away from intensive microcontroller I²C polling routines (which consume power) and toward a more independent light sensor that can instruct a system to “wake up” or “go to sleep.”

An ALS interrupt event (ALS_FLAG) is governed by Registers 5 through 7. The user writes high and low threshold values to these registers, and the ISL29030A issues an ALS interrupt flag if the actual counts stored in Registers 0x9 and 0xA are outside the user-programmed window. The user must write 0 to clear the ALS_FLAG.

A proximity interrupt event (PROX_FLAG) is governed by the high and low thresholds in Registers 3 and 4 (PROX_LT and PROX_HT). PROX_FLAG is set when the measured proximity data is greater than the high threshold a user-specified consecutive number of times (X; set by the user; see next paragraph). The proximity interrupt flag is cleared when the proximity data is lower than the low proximity threshold X consecutive times, or when the user writes “0” to PROX_FLAG.

Interrupt persistency is another useful option available for both ALS and proximity measurements. Persistency requires a user-specified number (X) of consecutive interrupt flags before the $\overline{\text{INT}}$ pin is driven low. Both ALS and Prox have their own independent interrupt persistency options. See ALS_PRST and PROX_PRST bits in Register 2.

The final interrupt option is the ability to AND or OR the two interrupt flags using Register 2 Bit 0 (INT_CTRL). If the user wants simultaneous ALS and Prox interrupts to happen before changing the state of the interrupt pin, the user sets this bit high. If the user wants the interrupt pin to change state when *either* the ALS or the Proximity interrupt flag goes high, the user leaves this bit at its default value of 0.

Analog-Out I_{ALS} Pin

When ALS_EN = 1, the analog I_{ALS} output pin sources a current directly proportional to the digital count stored in register bits ALSIRDATA[11:0]. When ALS_EN = 0, this pin is in a high impedance state. See Figure 15 for the effects of the compliance voltage ($V_{\text{I_ALS}}$) on I_{ALS}.

ALS Range 1 Considerations

When measuring ALS counts higher than 1800 on range 1 (ALSIR_MODE = 0, ALS_RANGE = 0, ALS_DATA > 1800), the user must switch to range 2 (change the ALS_RANGE bit from 0 to 1) and re-measure ALS counts. This recommendation pertains only to applications where the light incident upon the sensor is IR-heavy and is distorted by tinted glass that *increases* the ratio of infrared to visible light. For more information, contact the factory.

V_{DD} Power-up and Power Supply Considerations

At power-up, ensure a V_{DD} slew rate of 0.5V/ms or greater. After power-up, or if the power supply temporarily deviates from the factory specification (2.25V to 3.63V), Intersil recommends the user write the following: 0x00 to register 0x01, 0x29 to register 0x0F, 0x00 to register 0x0E, and 0x00 to register 0x0F. The user should then wait ~1ms or more and then rewrite all registers to the desired values. If the user prefers a hardware reset method instead of writing to test registers, then set V_{DD} = 0V for 1 second or more, power up again at the required slew rate, and write the desired values to the registers.

Power-Down

The user can set power-down in two ways. The first is to set both PROX_EN and ALS_EN bits to 0 in Register 1. The second and more simple way is to set all bits in Register 1 to 0 (0x00).

Calculating Lux

When in ALS mode, the ISL29030A ADC output codes are directly proportional to lux (see ALSIR_MODE bit).

$$E_{\text{calc}} = \alpha_{\text{RANGE}} \times \text{OUT}_{\text{ADC}} \quad (\text{EQ. 2})$$

In Equation 2, E_{calc} is the calculated lux reading, and OUT represents the ADC code. The constant, α , which is to plug in, is determined by the range bit, ALS_RANGE (register 0x1 bit 1) and is independent of the light source type.

TABLE 15. ALS SENSITIVITY AT DIFFERENT RANGES

ALS_RANGE	α_{RANGE} (Lux/Count)
0	0.0326
1	0.522

Table 15 shows two different scale factors: one for the low range (ALS_RANGE = 0) and the other for the high range (ALS_RANGE = 1).

Noise Rejection

Charge balancing ADCs have excellent noise-rejection characteristics for periodic noise sources for which frequency is an integer multiple of the conversion rate. For instance, a 60Hz AC unwanted signal's sum from 0ms to $k \cdot 16.66\text{ms}$ ($k = 1, 2, \dots, k_i$) is zero. Similarly, setting the device's integration time to be an integer multiple of the periodic noise signal greatly improves the light sensor output signal in the presence of noise. Since wall sockets may output at 60Hz or 50Hz, the factory-set integration time is 100ms, which is the lowest common integer number of cycles for both frequencies.

Proximity Detection of Various Objects

Proximity sensing relies on the amount of IR reflected back from objects. A perfectly black object absorbs all light and reflects no photons. The ISL29030A is sensitive enough to detect black ESD foam, which reflects only 1% of IR. For biological objects, blonde hair reflects more than brown hair, and customers may notice that skin tissue is much more reflective than hair. IR penetrates into the skin and is reflected or scattered back from within. As a result, the proximity count peaks at contact and monotonically decreases as skin moves away. The reflective characteristics of skin are very different from that of paper.

Typical Circuit

A typical application for the ISL29030A is shown in Figure 5. The ISL29030A I²C address is internally hardwired as 0b1000100. The device can be tied onto a system I²C bus together with other I²C compliant devices.

Soldering Considerations

Convection heating is recommended for reflow soldering; direct-infrared heating is not recommended. The plastic ODFN package does not require a custom reflow soldering profile, and is qualified to +260°C. A standard reflow soldering profile with a +260°C maximum is recommended.

Suggested PCB Footprint

It is important that users see [TB477](#), "Surface Mount Assembly Guidelines for Optical Dual FlatPack No Lead (ODFN) Package" before starting ODFN product board mounting.

Layout Considerations

The ISL29030A is relatively insensitive to layout. Like other I²C devices, it is intended to provide excellent performance, even in significantly noisy environments. To ensure best performance, route the supply and I²C traces as far as possible from all sources of noise, and place a 0.1µF and 1µF power supply decoupling capacitor close to the device.

ALS Sensor Window Layout

Special care should be taken to ensure that the sensor is uniformly illuminated, as shown in Figure 16, "8 LD ODFN SENSOR LOCATION OUTLINE - DIMENSIONS IN mm". Shadows from window openings that affect uniform illumination can distort measurement results.

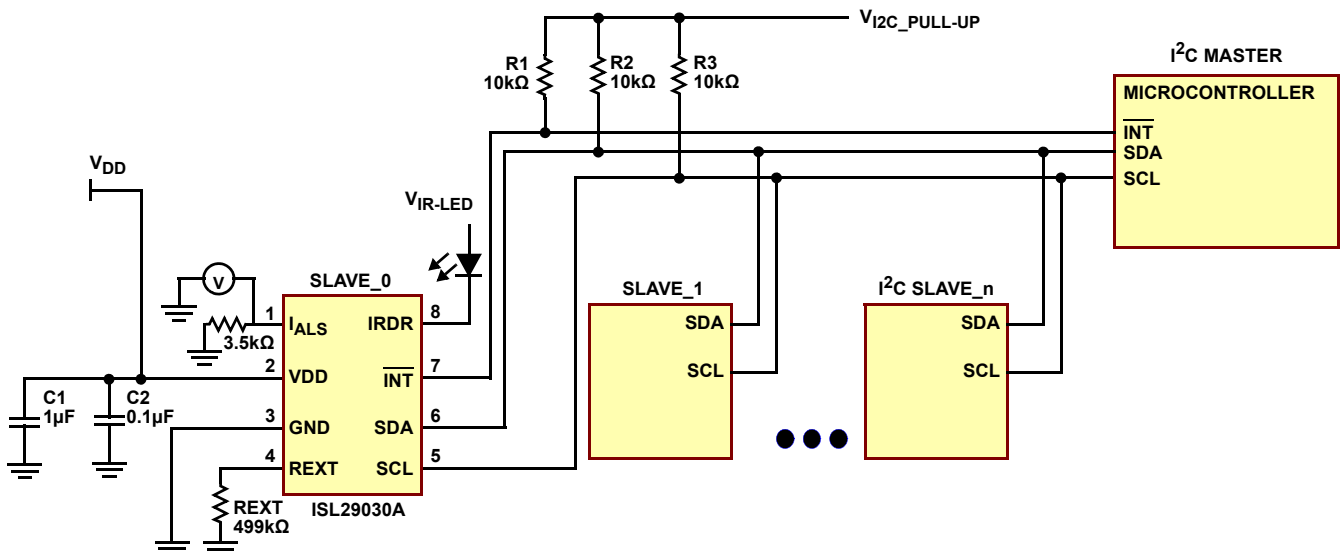

FIGURE 5. ISL29030A TYPICAL CIRCUIT

Typical Performance Curves $V_{DD} = 3.0V$, $R_{EXT} = 499k\Omega$

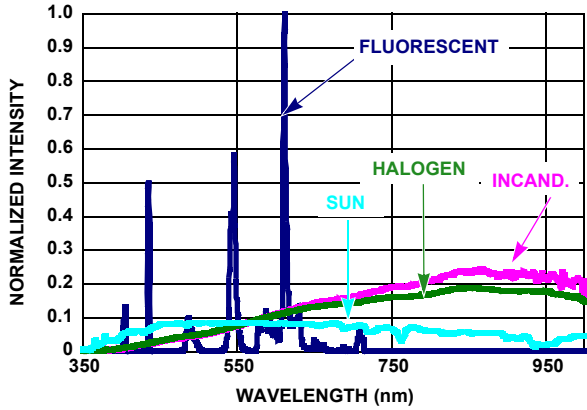

FIGURE 6. SPECTRUM OF FOUR LIGHT SOURCES NORMALIZED BY LUMINOUS INTENSITY (LUX)

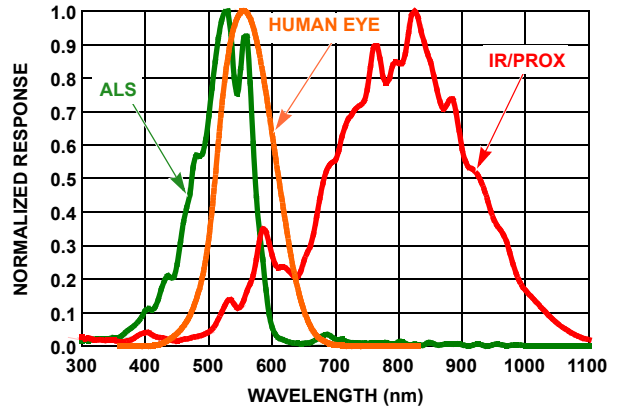

FIGURE 7. ISL29030A SENSITIVITY TO DIFFERENT WAVELENGTHS

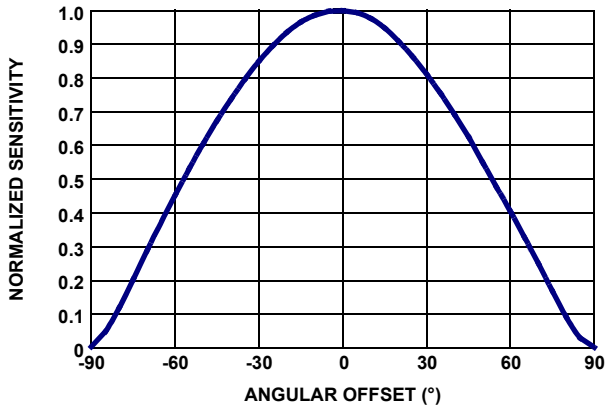

FIGURE 8. ANGULAR SENSITIVITY

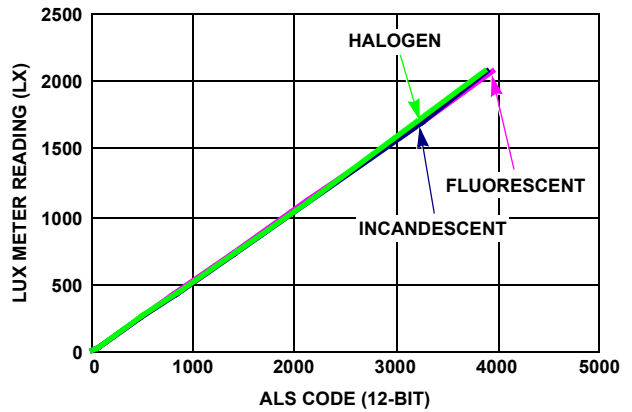

FIGURE 9. ALS LINEARITY OVER 3 LIGHT SOURCES (2000 LUX RANGE)

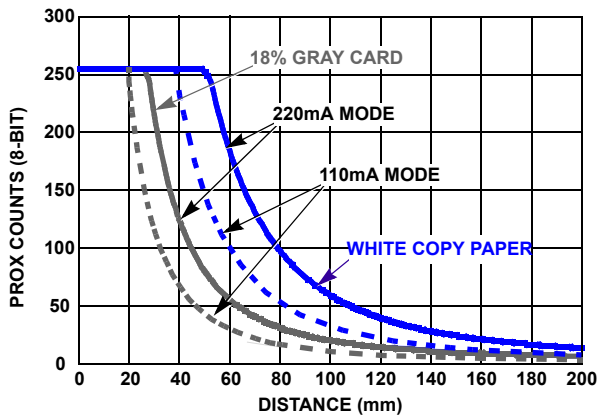

FIGURE 10. PROX COUNTS vs DISTANCE WITH 10CM x 10CM REFLECTOR (USING ISL29030A EVALUATION BOARD)

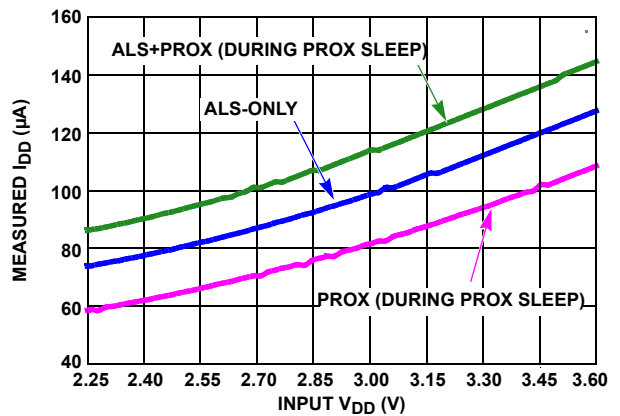

FIGURE 11. V_{DD} vs I_{DD} FOR VARIOUS MODES OF OPERATION (I_{ALS} PIN FLOATING)

Typical Performance Curves $V_{DD} = 3.0V$, $R_{EXT} = 499k\Omega$ (Continued)

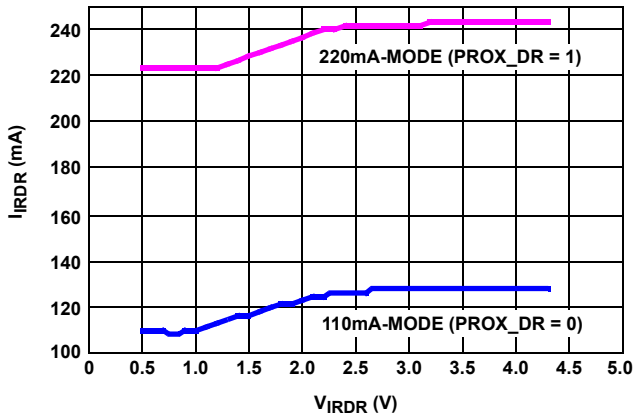

FIGURE 12. IRDR PULSE AMPLITUDE vs V_{IRDR}

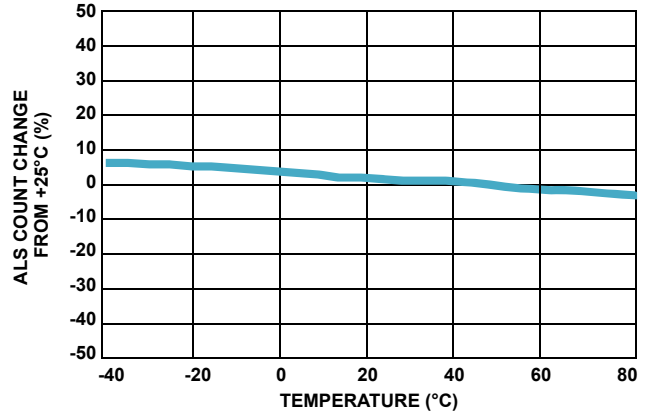

FIGURE 13. STABILITY OF ALS COUNT OVER-TEMPERATURE (AT 300 LUX)

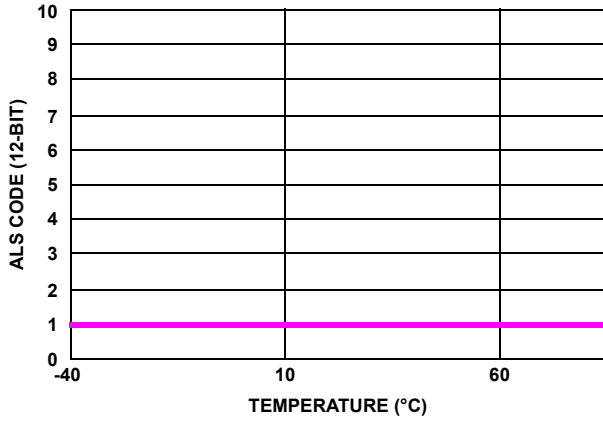

FIGURE 14. STABILITY OF ALS COUNT OVER-TEMPERATURE (AT 0.00 LUX)

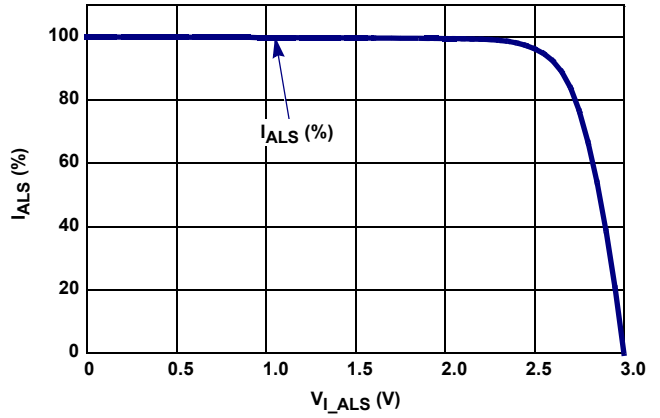

FIGURE 15. COMPLIANCE VOLTAGE (V_{I_ALS}) EFFECTS ON I_{ALS} (REFERENCED TO $V_{I_ALS} = 0V$)

ISL29030A

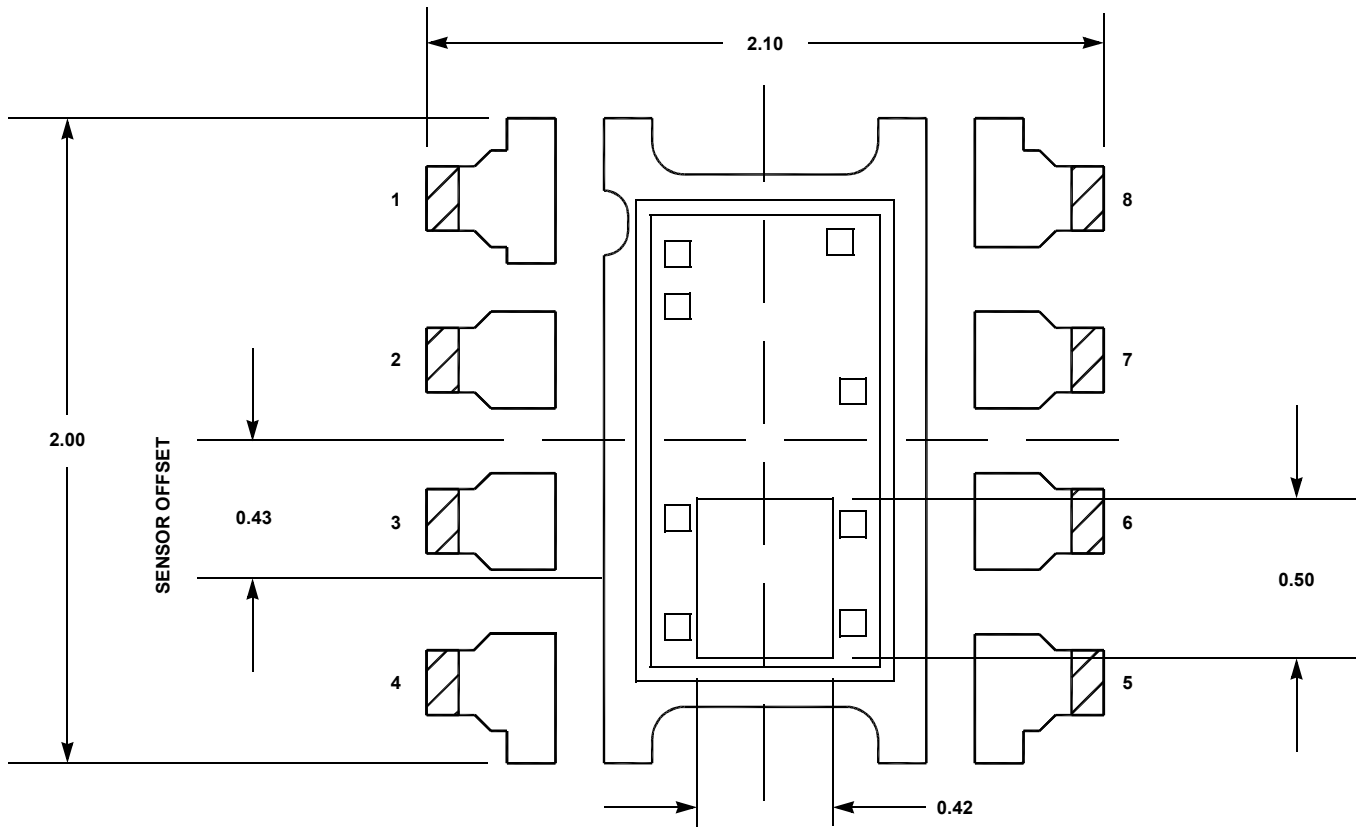

FIGURE 16. 8 LD ODFN SENSOR LOCATION OUTLINE - DIMENSIONS IN mm

Revision History

The revision history provided is for informational purposes only and is believed to be accurate, but not warranted. Please go to web to make sure you have the latest Rev.

DATE	REVISION	CHANGE
8/12/2011	FN7722.2	Page 10: In "ALS Range 1 Considerations", added "For more information, contact the factory."
3/18/2011	FN7722.1	Page 7, Table 2, changed ACCESS from R0 to (n/a) Page 10, Eq. 1, added "+ 540 μ s" to the divisor, T _{SLEEP} . Changed I _{IRDR} (AVE) to I _{IRDR} (AVG). Page 10, in "ALS Range 1 Considerations" section, removed reference to document of that title. Page 11, added section, "ALS Sensor Window Layout" Page 16, replaced Package Outline Drawing Rev 1, dated 12/09 with Rev 3, dated 1/11. Converted to latest Intersil datasheet template
11/18/10	FN7722.0	Initial release

About Intersil

Intersil Corporation is a leader in the design and manufacture of high-performance analog, mixed-signal and power management semiconductors. The company's products address some of the fastest growing markets within the industrial and infrastructure, personal computing and high-end consumer markets. For more information about Intersil or to find out how to become a member of our winning team, visit our website and career page at www.intersil.com.

For a complete listing of Applications, Related Documentation and Related Parts, please see the respective product information page. Also, please check the product information page to ensure that you have the most updated datasheet: [ISL29030A](http://www.intersil.com/ISL29030A)

To report errors or suggestions for this datasheet, please go to: www.intersil.com/askourstaff

Reliability reports are available from our website at: <http://rel.intersil.com/reports/search.php>

For additional products, see www.intersil.com/product_tree

Intersil products are manufactured, assembled and tested utilizing ISO9001 quality systems as noted in the quality certifications found at www.intersil.com/design/quality

Intersil products are sold by description only. Intersil Corporation reserves the right to make changes in circuit design, software and/or specifications at any time without notice. Accordingly, the reader is cautioned to verify that data sheets are current before placing orders. Information furnished by Intersil is believed to be accurate and reliable. However, no responsibility is assumed by Intersil or its subsidiaries for its use; nor for any infringements of patents or other rights of third parties which may result from its use. No license is granted by implication or otherwise under any patent or patent rights of Intersil or its subsidiaries.

For information regarding Intersil Corporation and its products, see www.intersil.com

Package Outline Drawing

L8.2.1x2.0

8 LEAD OPTICAL DUAL FLAT NO-LEAD PLASTIC PACKAGE (ODFN)

Rev 3, 1/11

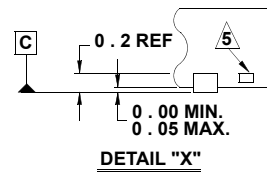
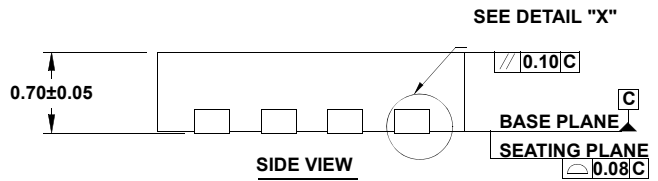
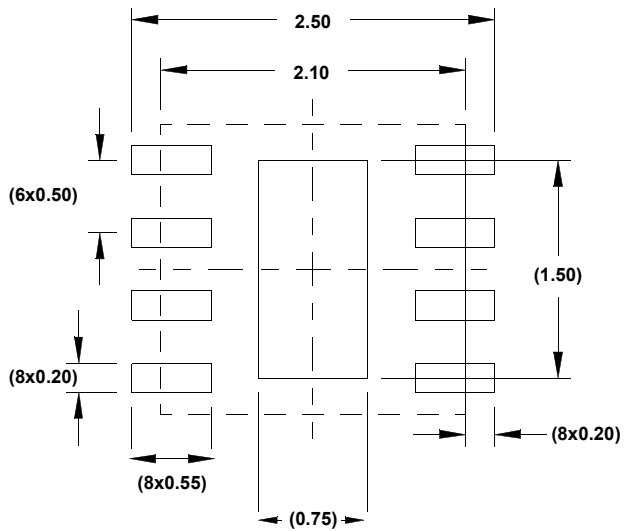
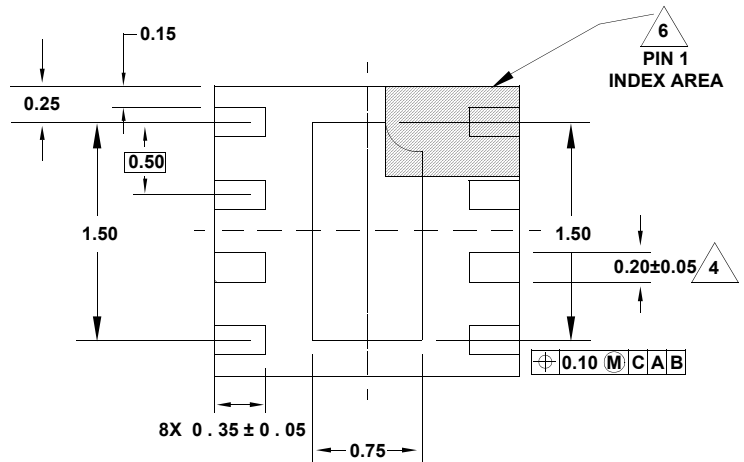
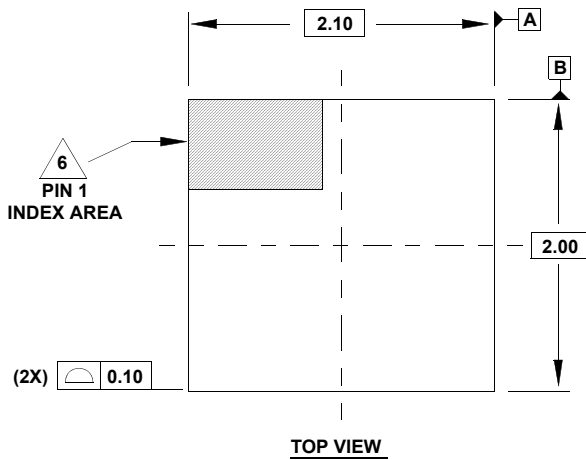

NOTES:

1. Dimensions are in millimeters.
Dimensions in () for Reference Only.
2. Dimensioning and tolerancing conform to ASME Y14.5m-1994.
3. Unless otherwise specified, tolerance : Decimal ± 0.05
4. Dimension applies to the metallized terminal and is measured between 0.25mm and 0.35mm from the terminal tip.
5. Tiebar shown (if present) is a non-functional feature.
6. The configuration of the pin #1 identifier is optional, but must be located within the zone indicated. The pin #1 identifier may be either a mold or mark feature.