

PART NUMBER: V78XX-1000 series

DESCRIPTION: DC switching regulator, non-isolated

description

The V78XX series of switching regulators are designed to replace 78XX linear regulators, with the objective of drop-in replacement without the need for a heatsink, because the V78XX series features high efficiency under all line conditions. Built-in short-circuit and over-temperature protections ensure very rugged operations. Additionally, low ripple and noise performance make the parts useful in a wide range of applications.

features

- efficiency up to 95%
- no need for heatsinks
- wide input range
- short circuit protection
- thermal shutdown
- low ripple and noise
- pin compatible to LM78XX series
- non-isolated



model number	input voltage range	output voltage	output current	efficiency	
				Vin_min	Vin_max
V7803-1000	4.75~28 Vdc	3.3 Vdc	1000 mA	90%	83%
V7805-1000	6.5~32 Vdc	5 Vdc	1000 mA	93%	88%
V7806-1000	8~32 Vdc	6.5 Vdc	1000 mA	94%	90%
V7809-1000	11~32 Vdc	9 Vdc	1000 mA	95%	92%
V7812-1000	15~32 Vdc	12 Vdc	1000 mA	95%	94%

OUTPUT SPECIFICATIONS

item	conditions	min.	typ.	max.	unit
output voltage accuracy	at 100% load		±2	±3	%
line regulation	Vin = min. to max. at full load		±0.2	±0.4	%
load regulation	10% to 100% full load		±0.4	±0.6	%
output ripple	20 MHz bandwidth, output w/ 10µF cap		20	35	mVp-p
short circuit protection	continuous, auto recovery upon removal of short				
short circuit input power	load impedance is ≤ 0.1Ω		0.5	1.2	W
output current limit	subject to over-temp shutdown			2000	mA
switching frequency	fixed switching frequency topology	280	330	450	KHz
dynamic load stability	100% ↔ 10% load			±100	mV
quiescent current	Vin_min to Vin_max at no load		5	7	mA
thermal shutdown	internal IC junction		150		°C
temperature coefficient	-40°C ~ 85°C ambient			0.02	%/°C
max load capacitance				2000	µF

GENERAL SPECIFICATIONS

item	conditions	min.	typ.	max.	unit
operating temperature range	see derating curve	-40		85	°C
operating case temperature		-40		100	°C
storage temperature range		-55		125	°C
cooling	free air convection				
solderability	1.5 mm from case for 10 seconds			300	°C
storage humidity range	relative humidity, non-condensing	10		95	%
case material	plastic (UL94-V0)				
case thermal impedance				50	°C/W
MTBF	at 25°C per MIL-HDBK-217F	2,000,000			hours
package weight			3.7		grams

PART NUMBER: V78XX-1000 series

DESCRIPTION: DC switching regulator, non-isolated

MECHANICAL DRAWINGS

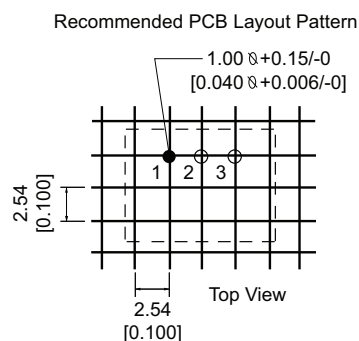
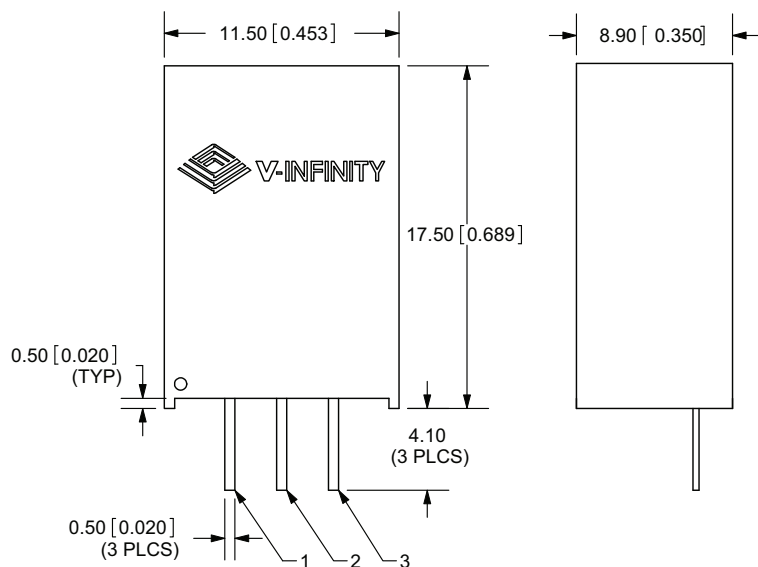

PIN	ASSIGNMENTS
1	+Vin
2	GND
3	+Vout

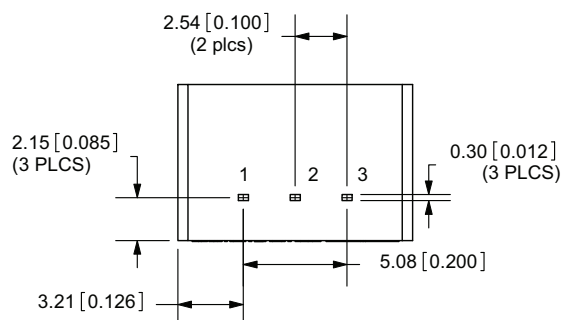

units: mm(inches)
pin tolerances: $\pm 0.10(\pm 0.004)$
general tolerances: $\pm 0.25(\pm 0.01)$

THERMAL DERATING CURVE

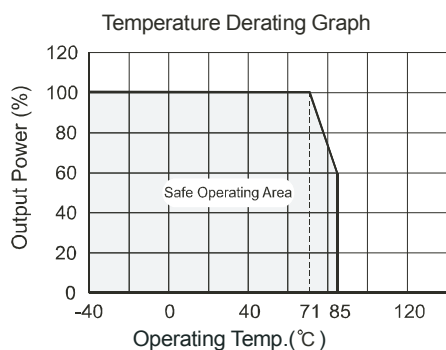

PART NUMBER: V78XX-1000 series

DESCRIPTION: DC switching regulator, non-isolated

TYPICAL APPLICATION CIRCUIT

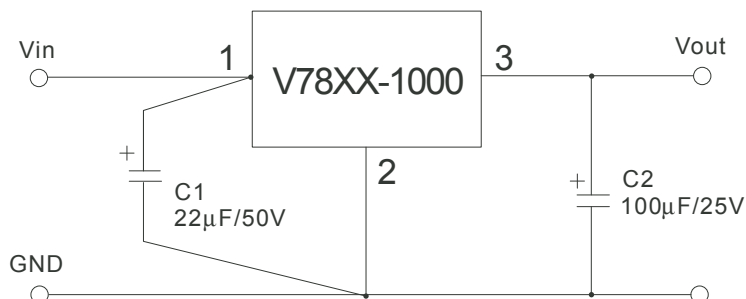

INPUT CAPACITOR (C1):

A low ESR capacitor is recommended to keep the noise at the converter to a minimum. Ceramic capacitors are preferred but tantalum or low ESR electrolytic capacitors may also suffice. Place C1 as close as possible to pins 1 & 2.

OUTPUT CAPACITOR (C2):

A 100µF/25V electrolytic capacitor is recommended.

NOT FOR PARALLEL OPERATION

This converter is not designed for parallel operation with another to increase output power.

TEST CIRCUIT

FOR EFFICIENCY & RIPPLE GRAPHS (PAGE4)

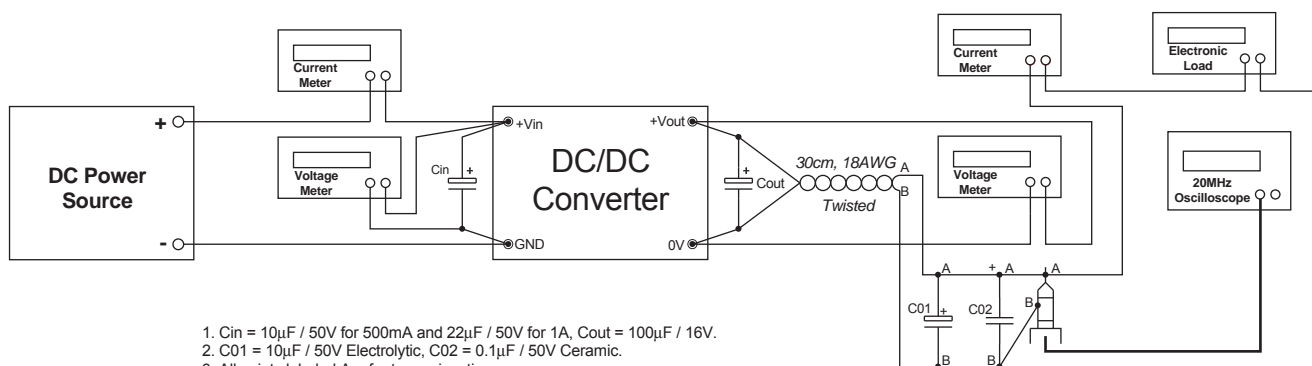

1. $C_{in} = 10\mu\text{F} / 50\text{V}$ for 500mA and $22\mu\text{F} / 50\text{V}$ for 1A, $C_{out} = 100\mu\text{F} / 16\text{V}$.
2. $C01 = 10\mu\text{F} / 50\text{V}$ Electrolytic, $C02 = 0.1\mu\text{F} / 50\text{V}$ Ceramic.
3. All points labeled A refer to one junction.
4. All points labeled B refer to one junction.
5. Use a short ground loop for probing. Do not use a wired ground clip.

PART NUMBER: V78XX-1000 series

DESCRIPTION: DC switching regulator, non-isolated

EFFICIENCY AND RIPPLE

Efficiency

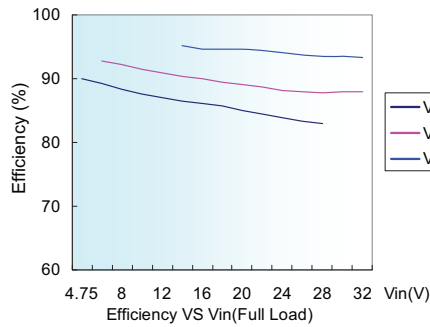

Output Ripple

