

This fixed-focus lens is designed for use with Panasonic's applicable projectors.
This lens is an ultra-short focal length lens which uses a mirror.

NOTE: The lens cannot be used by itself. It must be mounted onto the specified Panasonic DLP™ projector.

Specifications

F value:	2.0
Focal distance (f):	5.3 mm
Dimensions (W × H × D):	132 × 102 × 311 mm (5-3/16 × 4-1/32 × 12-1/4 inches)
Weight:	Approx 1.3 kg (3.1 lbs)
Applicable projector:	[Group A] PT-DZ870K/DZ870LK/DZ870W/DZ870LW/DW830K/DW830LK/DW830W/DW830LW/ DX100K/DX100LK/DX100W/DX100LW [Group B] PT-DZ770K/DZ770LK/DZ770S/DZ770LS/DW740S/DW740LS/DW740K/DW740LK/ DW730S/DW730LS/DW730K/DW730LK/DX810S/DX810LS/DX810K/DX810LK/DX800S/ DX800LS/DX800K/DX800LK/DZ680K/DZ680LK/DZ680S/DZ680LS/DW640K/DW640LK/ DW640S/DW640LS/DX610K/DX610LK/DX610S/DX610LS/DZ6710/DZ6710L/DZ6700/ DZ6700L/DW6300S/DW6300LS/DW6300K/DW6300LK/D6000S/D6000LS/D6000K/ D6000LK/D5000S/D5000LS [Group C] PT-RZ670/DZ670L/RW630/RW630L [Group D] PT-DZ780/DZ780L/DW750/DW750L/DX820/DX820L

Dimensions

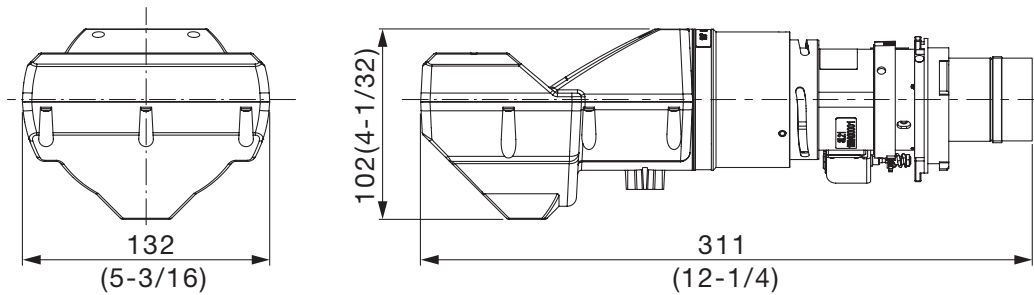
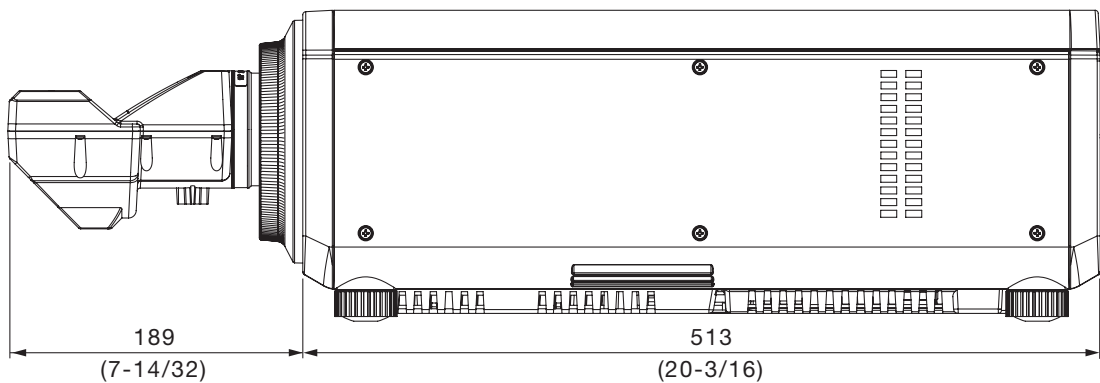

Illustration shows the lens attached to an applicable projector.

[Group A]



unit : mm (inch)

NOTE: This illustration is not drawn to scale.

[Group B]

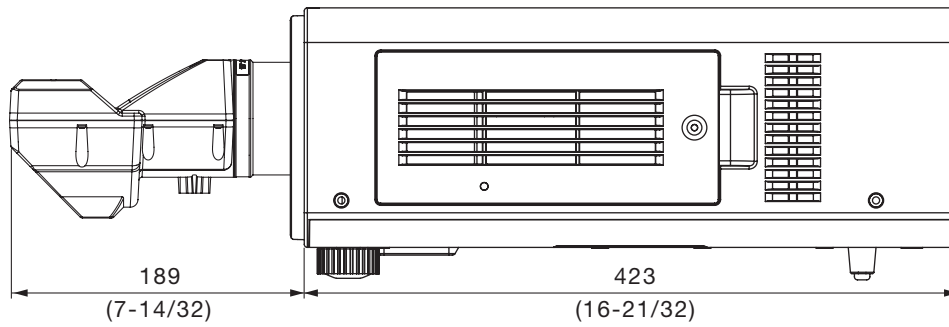

[Group C]

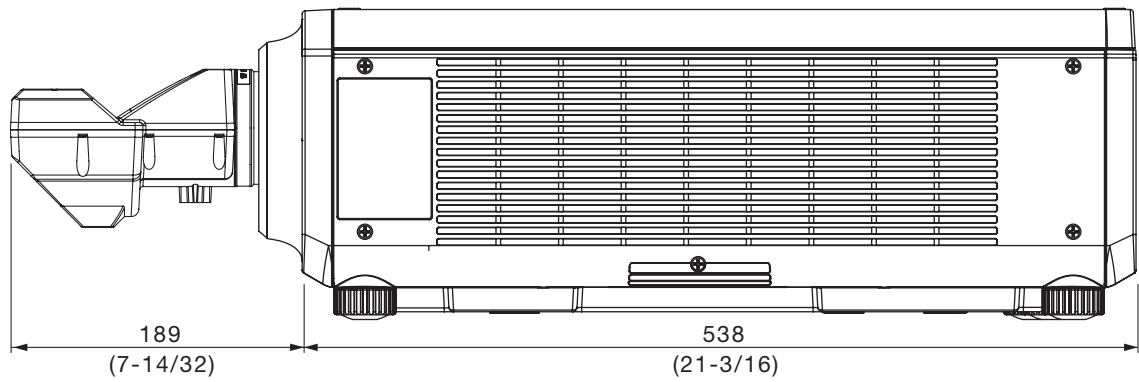

[Group D]

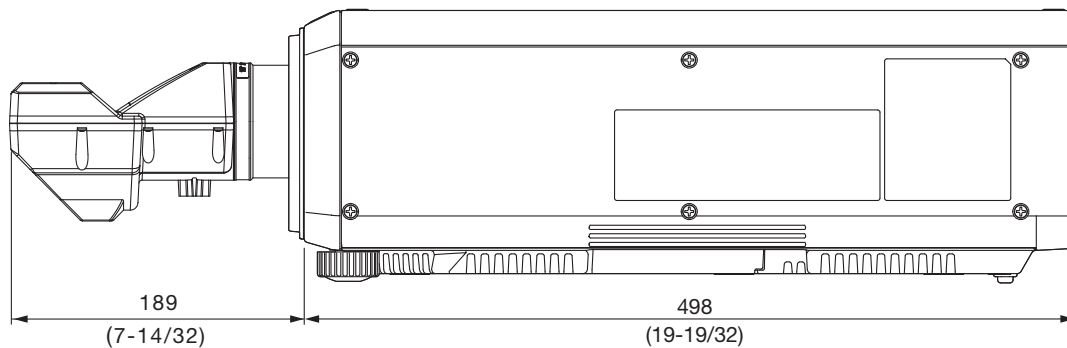

unit : mm (inch)
 NOTE: This illustration is not drawn to scale.

For information on the projection distance, refer to the specifications for the projector to which the lens will be mounted.
 DLP is a trademark of Texas Instruments. Weights and dimensions shown are approximate. Specifications subject to change without notice.

ET-DLE030 Projection Distance Table

RZ670/DZ870/DZ770/DZ680/DZ6710/DZ6700

16 : 10 (WUXGA ; 1920 × 1200)

Unit : meters

Ultra-short focal length lens ET-DLE030 Close-up system dimensions													
Throw ratio				0.38:1	(0.39:1)	From front of set to screen (L3)	From rear of set to screen (L4)			From top of set to bottom edge of screen (A1)		From bottom of set to bottom edge of screen (A2)	
Diagonal image size (Inches)	Diagonal image size (m)	Height (SH)	Width (SW)	Projection distance (From mirror reflective surface to screen) (L1)	From tip of lens to screen (L2)		RZ670	DZ870	DZ770 DZ680 DZ6710 DZ6700	RZ670 DZ870	DZ770 DZ680 DZ6710 DZ6700	RZ670 DZ870	DZ770 DZ680 DZ6710 DZ6700
100	2.54	1.35	2.15	0.82	0.84		0.65	0.12	0.14	0.23	0.43	0.44	0.63
120	3.05	1.62	2.59	0.98	1.00	0.82	0.28	0.30	0.39	0.53	0.54	0.73	0.71
150	3.81	2.02	3.23	1.23	1.25	1.06	0.52	0.55	0.64	0.68	0.69	0.88	0.86
200	5.08	2.69	4.31	1.63	1.66	1.47	0.93	0.95	1.04	0.93	0.94	1.13	1.11
250	6.35	3.37	5.39	2.04	2.06	1.87	1.34	1.36	1.45	1.18	1.19	1.38	1.36
300	7.62	4.04	6.46	2.45	2.47	2.28	1.74	1.77	1.86	1.43	1.44	1.63	1.61
350	8.89	4.71	7.54	2.85	2.88	2.69	2.15	2.18	2.27	1.69	1.69	1.89	1.87

Unit : feet

Ultra-short focal length lens ET-DLE030 Close-up system dimensions													
Throw ratio				0.38:1	(0.39:1)	From front of set to screen (L3)	From rear of set to screen (L4)			From top of set to bottom edge of screen (A1)		From bottom of set to bottom edge of screen (A2)	
Diagonal image size (Inches)	Diagonal image size (m)	Height (SH)	Width (SW)	Projection distance (From mirror reflective surface to screen) (L1)	From tip of lens to screen (L2)		RZ670	DZ870	DZ770 DZ680 DZ6710 DZ6700	RZ670 DZ870	DZ770 DZ680 DZ6710 DZ6700	RZ670 DZ870	DZ770 DZ680 DZ6710 DZ6700
100	2.54	4.4	7.1	2.7	2.8		2.1	0.4	0.5	0.8	1.4	1.4	2.1
120	3.05	5.3	8.5	3.2	3.3	2.7	0.9	1.0	1.3	1.7	1.8	2.4	2.3
150	3.81	6.6	10.6	4.0	4.1	3.5	1.7	1.8	2.1	2.2	2.3	2.9	2.8
200	5.08	8.8	14.1	5.4	5.4	4.8	3.0	3.1	3.4	3.1	3.1	3.7	3.6
250	6.35	11.0	17.7	6.7	6.8	6.1	4.4	4.5	4.8	3.9	3.9	4.5	4.5
300	7.62	13.3	21.2	8.0	8.1	7.5	5.7	5.8	6.1	4.7	4.7	5.4	5.3
350	8.89	15.5	24.7	9.4	9.4	8.8	7.1	7.1	7.4	5.5	5.5	6.2	6.1

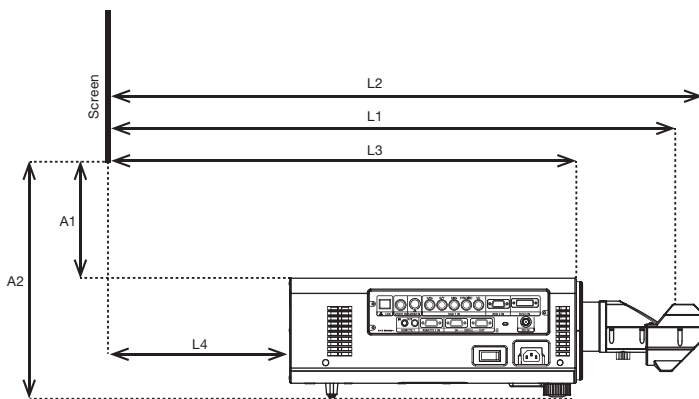

- L1: Projection distance (from screen to mirror reflective surface)
- L2: From screen to tip of lens
- L3: From screen to front of set
- L4: From screen to rear of set
- A1: From bottom edge of screen to top of set
- A2: From bottom edge of screen to bottom of set

Projection Distance Calculation Table

Screen aspect ratio 16:10

Projection distance calculation formula

$$L1 \text{ (m)} = 0.3205 \times \text{Diagonal image size} + 0.00467$$

Calculation formula for distance from top of set to bottom edge of screen

RZ670/DZ870	A1 (m) = 0.1977 x Diagonal image size - 0.07210
DZ770/DZ680/DZ6710/DZ6700	A1 (m) = 0.1977 x Diagonal image size - 0.06710

RW630/DW830/DW740/DW730/DW640/DW6300

16 : 10 (WXGA ; 1280 × 800)

Unit : meters

Ultra-short focal length lens ET-DLE030
Close-up system dimensions

Diagonal image size (Inches)	Diagonal image size (m)	Throw ratio		Projection distance (From mirror reflective surface to screen) (L1)	From tip of lens to screen (L2)	From front of set to screen (L3)	From rear of set to screen (L4)			From top of set to bottom edge of screen (A1)		From bottom of set to bottom edge of screen (A2)	
		0.40:1	(0.41:1)				RW630	DW830	DW740 DW730 DX640 DW6300	RW630 DW830	DW740 DW730 DX640 DW6300	RW630 DW830	DW740 DW730 DX640 DW6300
100	2.54	1.35	2.15	0.86	0.88	0.69	0.16	0.18	0.27	0.59	0.59	0.79	0.77
120	3.05	1.62	2.59	1.03	1.05	0.86	0.33	0.35	0.44	0.72	0.72	0.92	0.90
150	3.81	2.02	3.23	1.29	1.31	1.12	0.58	0.61	0.70	0.92	0.92	1.12	1.10
200	5.08	2.69	4.31	1.71	1.74	1.55	1.01	1.04	1.13	1.25	1.25	1.45	1.43
250	6.35	3.37	5.39	2.14	2.16	1.98	1.44	1.46	1.55	1.58	1.58	1.78	1.76
300	7.62	4.04	6.46	2.57	2.59	2.40	1.86	1.89	1.98	1.91	1.91	2.11	2.09
350	8.89	4.71	7.54	3.00	3.02	2.83	2.29	2.32	2.41	2.24	2.24	2.44	2.42

Unit : feet

Ultra-short focal length lens ET-DLE030
Close-up system dimensions

Diagonal image size (Inches)	Diagonal image size (m)	Throw ratio		Projection distance (From mirror reflective surface to screen) (L1)	From tip of lens to screen (L2)	From front of set to screen (L3)	From rear of set to screen (L4)			From top of set to bottom edge of screen (A1)		From bottom of set to bottom edge of screen (A2)	
		0.40:1	(0.41:1)				RW630	DW830	DW740 DW730 DX640 DW6300	RW630 DW830	DW740 DW730 DX640 DW6300	RW630 DW830	DW740 DW730 DX640 DW6300
100	2.54	4.4	7.1	2.8	2.9	2.3	0.5	0.6	0.9	1.9	1.9	2.6	2.5
120	3.05	5.3	8.5	3.4	3.5	2.8	1.1	1.2	1.4	2.4	2.4	3.0	2.9
150	3.81	6.6	10.6	4.2	4.3	3.7	1.9	2.0	2.3	3.0	3.0	3.7	3.6
200	5.08	8.8	14.1	5.6	5.7	5.1	3.3	3.4	3.7	4.1	4.1	4.7	4.7
250	6.35	11.0	17.7	7.0	7.1	6.5	4.7	4.8	5.1	5.2	5.2	5.8	5.8
300	7.62	13.3	21.2	8.4	8.5	7.9	6.1	6.2	6.5	6.3	6.3	6.9	6.8
350	8.89	15.5	24.7	9.8	9.9	9.3	7.5	7.6	7.9	7.3	7.3	8.0	7.9

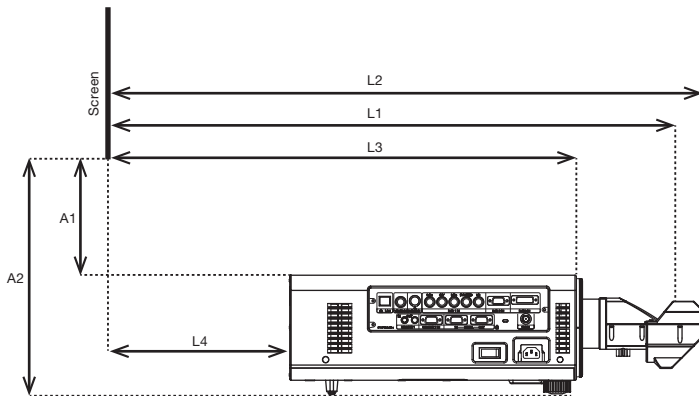

- L1: Projection distance (from screen to mirror reflective surface)
- L2: From screen to tip of lens
- L3: From screen to front of set
- L4: From screen to rear of set
- A1: From bottom edge of screen to top of set
- A2: From bottom edge of screen to bottom of set

Projection Distance Calculation Table

Screen aspect ratio 16:10

Projection distance calculation formula

$$L1 (m) = 0.3365 \times \text{Diagonal image size} + 0.00467$$

Calculation formula for distance from top of set to bottom edge of screen

RW630/DW830	A1 (m) = 0.2597 × Diagonal image size - 0.07396
DW740/DW730/DW640/DW6300	A1 (m) = 0.2597 × Diagonal image size - 0.06896

DX100/DX810/DX800/DX610/D6000/D5000

4 : 3 (XGA ; 1024 x 768)

Unit : meters

Ultra-short focal length lens ET-DLE030
Close-up system dimensions

Throw ratio				0.39:1	(0.41:1)	From front of set to screen (L3)	From rear of set to screen (L4)		From top of set to bottom edge of screen (A1)		From bottom of set to bottom edge of screen (A2)	
Diagonal image size (Inches)	Diagonal image size (m)	Height (SH)	Width (SW)	Projection distance (From mirror reflective surface to screen) (L1)	From tip of lens to screen (L2)		DX100	DX810/DX800/DX610/D6000/D5000	DX100	DX810/DX800/DX610/D6000/D5000	DX100	DX810/DX800/DX610/D6000/D5000
100	2.54	1.52	2.03	0.80	0.82		0.63	0.12	0.21	0.41	0.41	0.61
120	3.05	1.83	2.44	0.96	0.98	0.79	0.28	0.37	0.50	0.51	0.70	0.68
150	3.81	2.29	3.05	1.20	1.22	1.03	0.52	0.61	0.65	0.65	0.85	0.83
200	5.08	3.05	4.06	1.60	1.62	1.43	0.92	1.01	0.88	0.89	1.08	1.06
250	6.35	3.81	5.08	1.99	2.02	1.83	1.32	1.41	1.12	1.13	1.32	1.30
300	7.62	4.57	6.10	2.39	2.42	2.23	1.71	1.80	1.36	1.37	1.56	1.54
350	8.89	5.33	7.11	2.79	2.81	2.62	2.11	2.20	1.60	1.61	1.80	1.78

Unit : feet

Ultra-short focal length lens ET-DLE030
Close-up system dimensions

Throw ratio				0.39:1	(0.41:1)	From front of set to screen (L3)	From rear of set to screen (L4)		From top of set to bottom edge of screen (A1)		From bottom of set to bottom edge of screen (A2)	
Diagonal image size (Inches)	Diagonal image size (m)	Height (SH)	Width (SW)	Projection distance (From mirror reflective surface to screen) (L1)	From tip of lens to screen (L2)		DX100	DX810/DX800/DX610/D6000/D5000	DX100	DX810/DX800/DX610/D6000/D5000	DX100	DX810/DX800/DX610/D6000/D5000
100	2.54	5.0	6.7	2.6	2.7		2.1	0.4	0.7	1.3	1.3	2.0
120	3.05	6.0	8.0	3.1	3.2	2.6	0.9	1.2	1.6	1.7	2.3	2.2
150	3.81	7.5	10.0	3.9	4.0	3.4	1.7	2.0	2.1	2.1	2.8	2.7
200	5.08	10.0	13.3	5.2	5.3	4.7	3.0	3.3	2.9	2.9	3.6	3.5
250	6.35	12.5	16.7	6.5	6.6	6.0	4.3	4.6	3.7	3.7	4.3	4.3
300	7.62	15.0	20.0	7.8	7.9	7.3	5.6	5.9	4.5	4.5	5.1	5.1
350	8.89	17.5	23.3	9.2	9.2	8.6	6.9	7.2	5.3	5.3	5.9	5.8

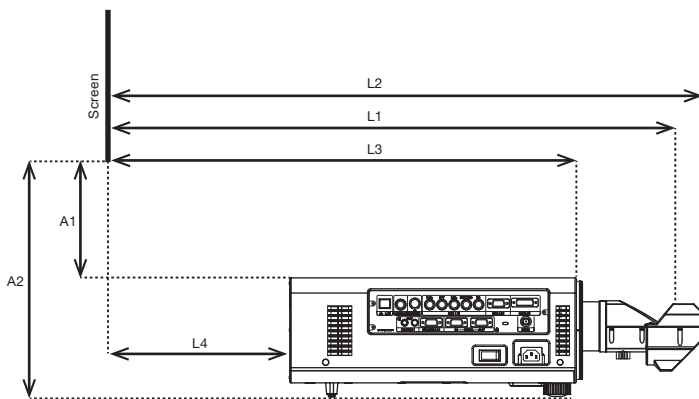

- L1: Projection distance
(from screen to mirror reflective surface)
- L2: From screen to tip of lens
- L3: From screen to front of set
- L4: From screen to rear of set
- A1: From bottom edge of screen to top of set
- A2: From bottom edge of screen to bottom of set

Projection Distance Calculation Table

Screen aspect ratio 4:3

Projection distance calculation formula

$L1 (m) = 0.3133 \times \text{Diagonal image size} + 0.00467$

Calculation formula for distance from top of set to bottom edge of screen

DX100	$A1 (m) = 0.1881 \times \text{Diagonal image size} - 0.07149$
DX810/DX800/DX610/D6000/D5000	$A1 (m) = 0.1881 \times \text{Diagonal image size} - 0.06649$