

DESCRIPTION

The EV8759-D-00A is used for demonstrating the performance of MP8759, a fully-integrated, high efficiency, synchronous step-down switch mode converter. MP8759 provides up to 8A continuous output current and 10A peak output current over a wide input supply range with constant-on-time control for fast loop response.

This part requires minimum number of external components and is available in QFN12 (2mmx3mm) package

ELECTRICAL SPECIFICATION

Parameter	Symbol	Value	Units
Input Voltage	V _{IN}	12	V
Output Voltage	V _{OUT}	1	V
Output Current	I _{OUT}	8	A
Switching Frequency	f _{SW}	700	kHz

FEATURES

- Wide 4.5V to 26V Operating Input Range
- Ultrasonic Mode
- 117µA low quiescent Current
- 8A Continuous Output Current
- 10A Peak Output Current
- Adaptive COT for Fast transient
- DC Auto Tune Loop
- Internal Soft Start
- Output Discharge
- 700kHz Switching Frequency
- OCP, OVP, UVP (Hiccup) Protection and Thermal Shutdown.
- Output Adjustable from 0.6V
- QFN-12 (2mm x 3mm) Package

APPLICATIONS

- Laptop Computer
- Tablet PC
- Networking Systems
- Personal Video Recorders
- Flat Panel Television and Monitors
- Distributed Power Systems

All MPS parts are lead-free and adhere to the RoHS directive. For MPS green status, please visit MPS website under Products, Quality Assurance page.

"MPS" and "The Future of Analog IC Technology", are Registered Trademarks of Monolithic Power Systems, Inc.

EV8759-D-00A EVALUATION BOARD



(L x W x H) 8.55cm x 8.55cm x 1.6cm

Board Number	MPS IC Number
EV8759-D-00A	MP8759GD

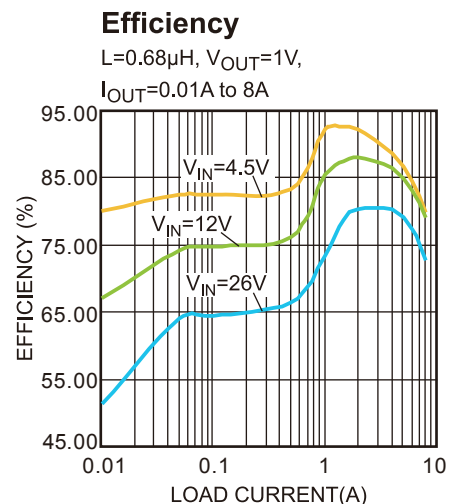

EVALUATION BOARD SCHEMATIC

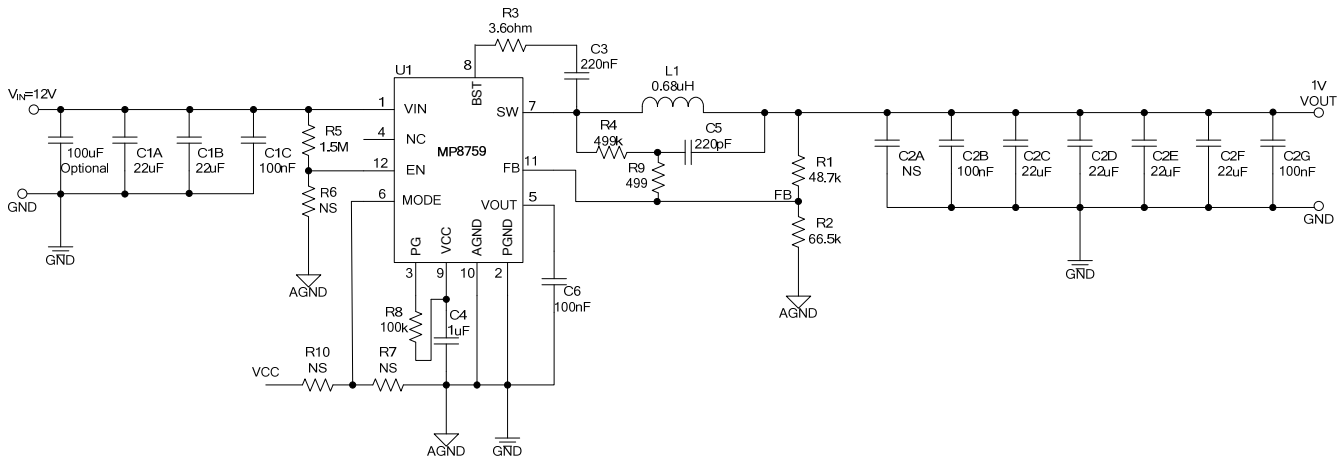

Note:

EN resistor divider value should be modified accordingly with different input voltage. Please refer to UVLO protection section on MP8759 datasheet for details.

EV8759-D-00A BILL OF MATERIALS

Qty	Ref	Value	Description	Package	Manufacturer	Manufacturer P/N
2	C1A,C1B	22µF	Ceramic Cap., 35V, X5R	1206	TDK	C3216X5R1V226M
4	C1C,C2B, C2G,C6	0.1µF	Ceramic Cap., 50V, X7R	0603	TDK	C1608X7R1H104K
0	C2A	NS				
4	C2C,C2D, C2E,C2F	22µF	Ceramic Cap., 6.3V, X5R	0805	TDK	C2012X5R0J226M
1	C3	0.22µF	Ceramic Cap., 25V, X7R	0603	TDK	C1068X7R1E224K
1	C4	1µF	Ceramic Cap., 16V, X5R	0603	TDK	C1608X5R1C105K
1	C5	220pF	Ceramic Cap., 50V, C0G	0603	TDK	C1608C0G1H221J
1	R1	48.7k	Film Res., 1%	0603	ROYAL	RC0603FR-0748K7L
1	R2	66.5k	Film Res., 1%	0603	ROYAL	RC0603FR-0766K5L
1	R3	3.6Ω	Film Res., 1%	0603	ROYAL	RL0603FR-073R6L
1	R4	499k	Film Res., 1%	0603	ROYAL	RL0603FR-07499KL
1	R5	1.5M	Film Res., 1%	0603	ROYAL	RL0603FR-071M5L
1	R8	100k	Film Res., 1%	0603	ROYAL	RL0603FR-07100KL
1	R9	499Ω	Film Res., 1%	0603	ROYAL	RL0603FR-07499RL
0	R6,R7,R10	NS				
1	L1	0.68µH	Inductor, DRC=3.1mΩ,Is=20A	SMD	Würth	744311068
1	U1	MP8759	Step-Down Converter	QFN-12 2mm×3mm	MPS	MP8759GD

EV8 TEST RESULTS

Performance waveforms are tested on the EV8759-D-00A.

V_{IN} = 12V, V_{OUT} = 1V, L = 0.68μH, T_J = +25°C, unless otherwise noted.

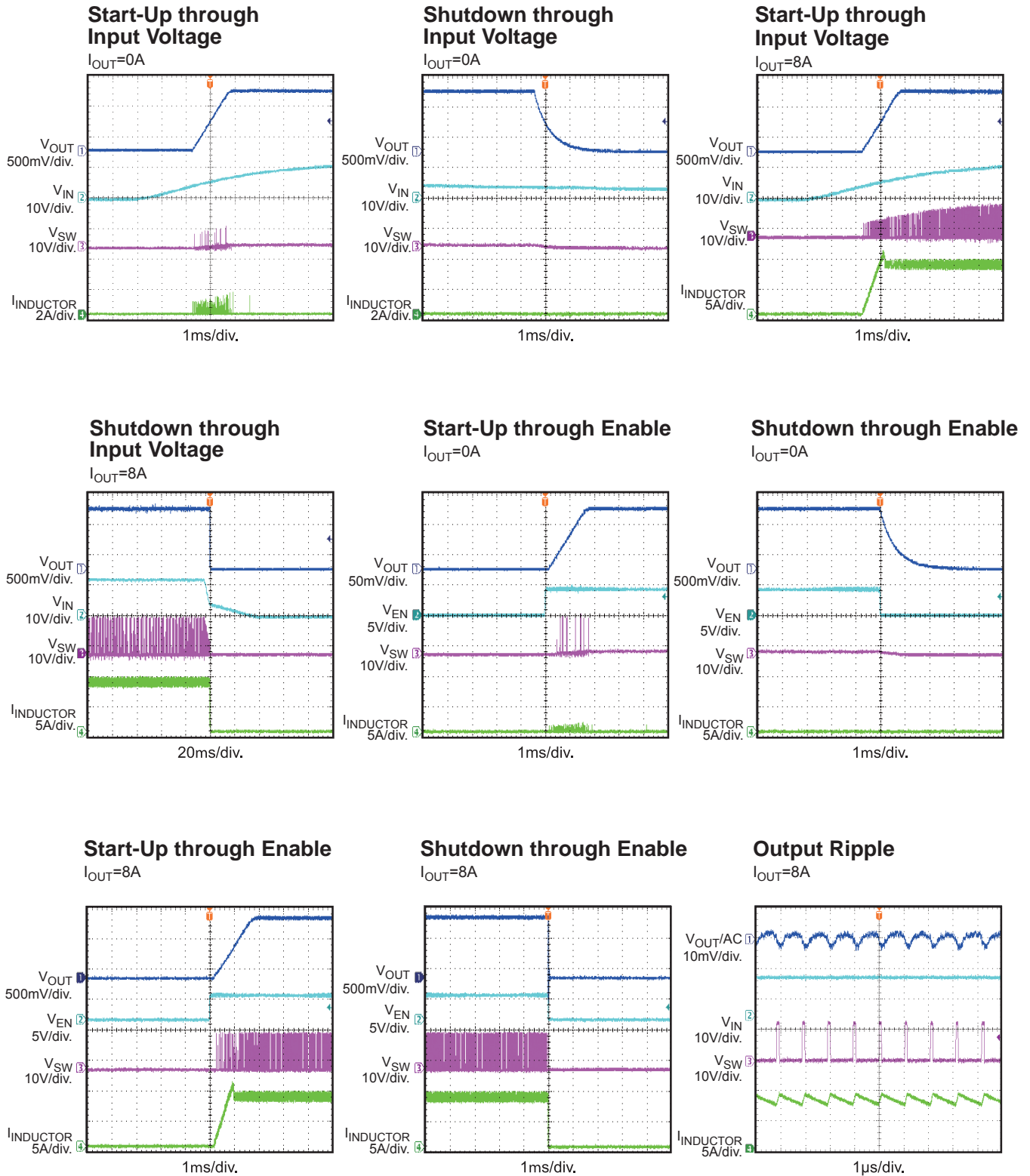

EVB TEST RESULTS (continued)

Performance waveforms are tested on the EV8759-D-00A.

 $V_{IN} = 12V$, $V_{OUT} = 1V$, $L = 0.68\mu H$, $T_J = +25^\circ C$, unless otherwise noted.

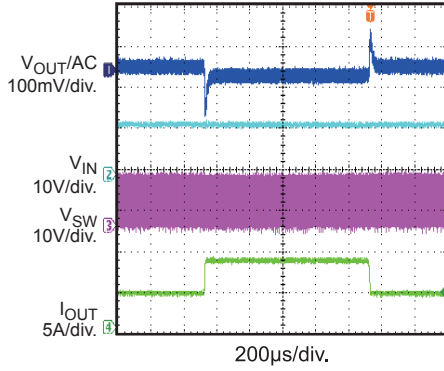
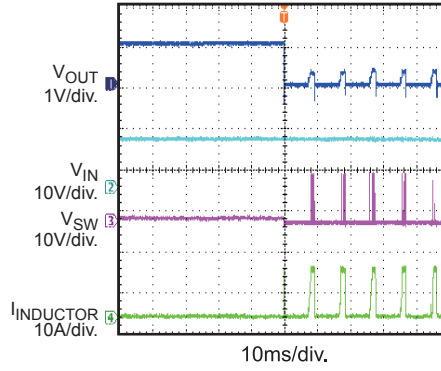
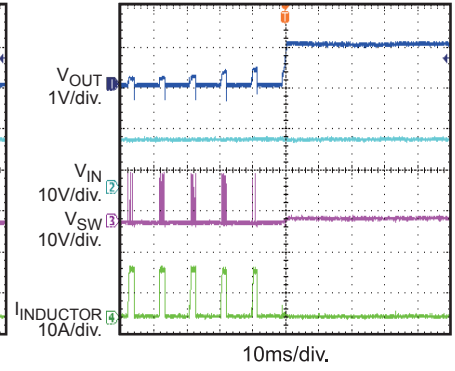
4A to 8A Load Transient

Short-Circuit Entry
 $I_{OUT} = 0A$

Short-Circuit Recovery
 $I_{OUT} = 0A$

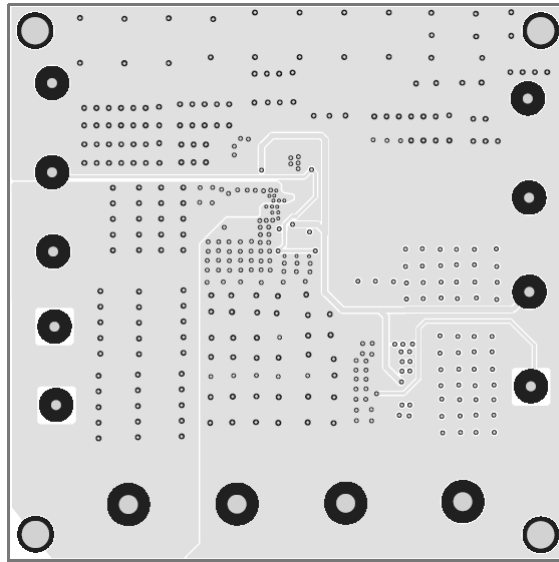

Figure 5: Bottom Layer

QUICK START GUIDE

1. Connect the positive and negative terminals of the load to the VOUT and GND pins respectively.
2. Preset the output of power supply at 12V, and then turn off the power supply.
3. Connect the positive and negative terminals of the power supply output to the VIN and GND pins respectively:
4. Turn the power supply on. The MP8759 will automatically start up.
5. To use the Enable function, apply a digital input to the EN pin. Drive EN high to turn on the regulator or low to turn it off
6. Use R1 and R2 to set the output voltage. Follow the Application information section in the device datasheet to select the proper value of R1, R2, inductor and output capacitor values when output voltage is changed.

NOTICE: The information in this document is subject to change without notice. Please contact MPS for current specifications. Users should warrant and guarantee that third party Intellectual Property rights are not infringed upon when integrating MPS products into any application. MPS will not assume any legal responsibility for any said applications.