

2.25 Volt Voltage Variable Absorptive Attenuator 42 dB, 1.8 - 2.5 GHz

AT-119
V9

Features

- Single Positive Voltage Control: 0 to +2.25 Volts
- 42 dB Typical Attenuation Range at 2.4 GHz
- Low DC Power Consumption
- SOT-25 Plastic Package
- Tape and Reel Packaging Available

Description

M/A-COM's AT-119 is a GaAs MMIC voltage variable absorptive attenuator in a low cost, SOT-25 five-lead, surface mount plastic package. M/A-COM fabricates the AT-119 with a proven monolithic GaAs 0.5 micron gate process that features full chip passivation for performance and reliability.

Applications

The AT-119 is ideally suited for applications that require fine tuning, linear attenuation with voltage, and very low power consumption.

Typical applications for the AT-119 include automatic gain control circuits in satellite radio receivers and other wireless receivers.

Ordering Information ¹

Part Number	Package
AT-119	SOT-25 Plastic Package
AT-119TR-3000	3000 piece reel
AT-119SMB	Sample Test Board (Includes 5 Samples)

1. Reference Application Note M513 for reel size information.

Functional Schematic

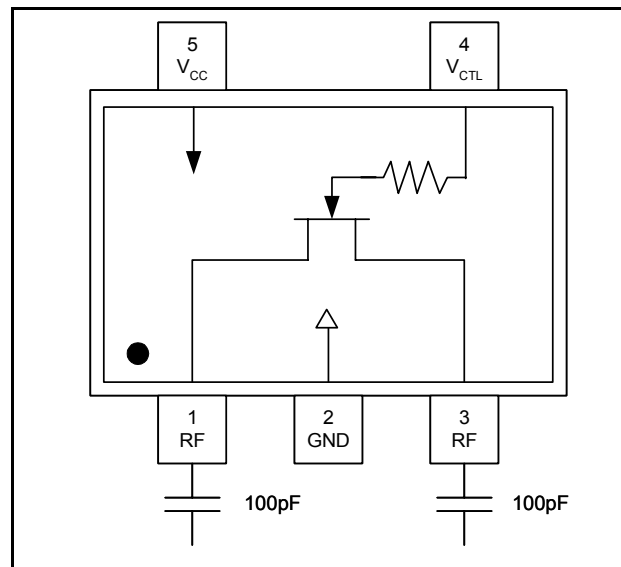

Pin Configuration

Pin	Function	Description
1	RF	RF (input / output)
2	GND	Ground
3	RF	RF (input / output)
4	V _{CTL}	Control Voltage
5	V _{CC}	DC Supply Voltage

Absolute Maximum Ratings ^{2,3}

T_A = +25°C (unless otherwise specified)

Parameter	Absolute Maximum
Input Power	+21 dBm
Supply Voltage V _{CC}	-1V ≤ V _{CC} ≤ +8 V
Control Voltage V _{CTL}	-1V ≤ V _{CTL} ≤ V _{CC} + 0.5 V
Operating Temperature	-40°C to +85°C
Storage Temperature	-65°C to +150°C

2. Exceeding any one or combination of these limits may cause permanent damage to this device.
3. M/A-COM does not recommend sustained operation near these survivability limits.

2.25 Volt Voltage Variable Absorptive Attenuator
42 dB, 1.8 - 2.5 GHz

AT-119
V9

Electrical Specifications: $T_A = 25^\circ\text{C}$, Frequency = 2.4 GHz, $V_{CC} = 3.3\text{ V}$, $Z_0 = 50\ \Omega$

Parameter	Test Conditions ^{4,5}	Units	Min.	Typ.	Max.
Insertion Loss	$V_{CTL} = 2.25\text{ V}$	dB	—	2.4	3.2
Maximum Attenuation	$V_{CTL} = 0.5\text{ V}$	dB	37	42	—
Attenuation Slope	$0.75\text{ V} < V_{CTL} < 1.75\text{ V}$	dB/V	24	—	—
Return Loss	$0.0\text{ V} < V_{CTL} < 0.75\text{ V}$	dB	—	6	—
	$0.75\text{ V} < V_{CTL} < 1.75\text{ V}$	dB	—	10	—
	$1.75\text{ V} < V_{CTL} < 2.25\text{ V}$	dB	—	14	—
Input Power for 1dB Change in Attenuation	$0.75\text{ V} < V_{CTL} < 2.25\text{ V}$	dBm	—	10	—
Input 3rd Order Intercept Point	$0.75\text{ V} < V_{CTL} < 2.25\text{ V}$	dBm	—	15	—
Switching Speed	50% V_{CTL} to 10% / 90% RF	nS	—	100	—
Transients	$V_{CTL} = 3\text{ V}$, In-Band	mV	—	10	—

4. External DC blocking capacitors are required on all RF ports.
5. $V_{CC} = +3.3\text{ V}$ @ 50 μA typical. $V_{CTL} = 0\text{ V}$ to +2.25 V @ 50 μA typical.

Application Schematic

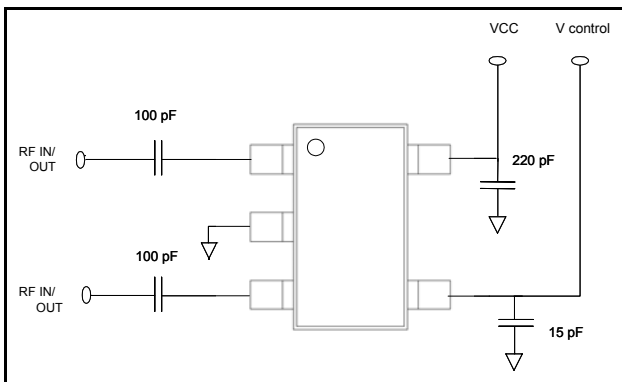

Handling Procedures

Please observe the following precautions to avoid damage:

Static Sensitivity

Gallium Arsenide Integrated Circuits are sensitive to electrostatic discharge (ESD) and can be damaged by static electricity. Proper ESD control techniques should be used when handling these devices.

**2.25 Volt Voltage Variable Absorptive Attenuator
42 dB, 1.8 - 2.5 GHz**

**AT-119
V9**

Typical Performance Curves

Insertion Loss vs. Frequency @ 2.25 V Control Voltage

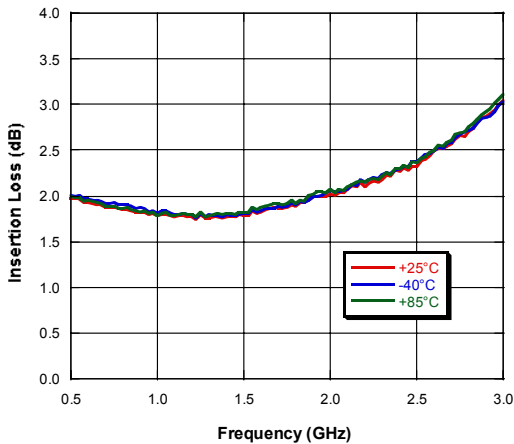

Attenuation vs. Control Voltage @ +25°C

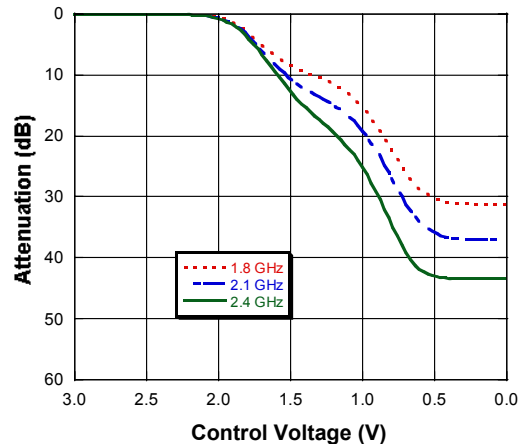

Typical Device Variation, 2.4 GHz

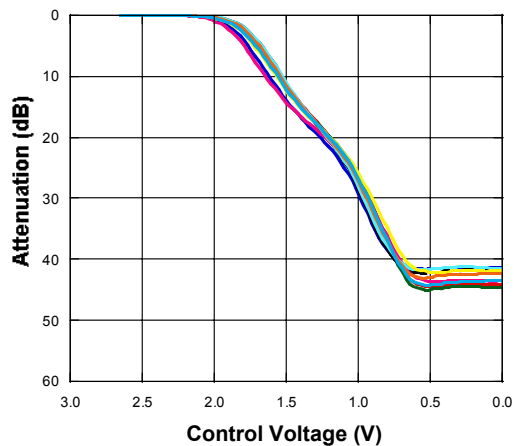

Attenuation vs. Frequency @ 0.0 V Control Voltage

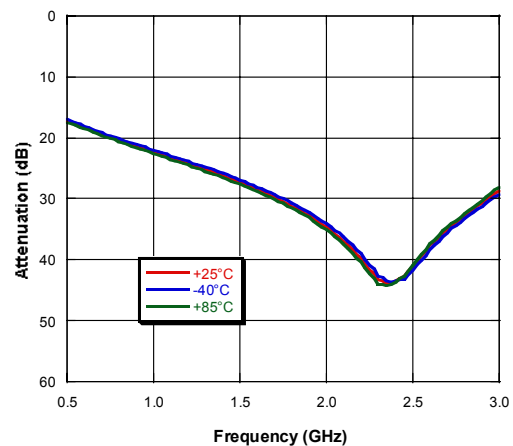

Return Loss vs. Control Voltage

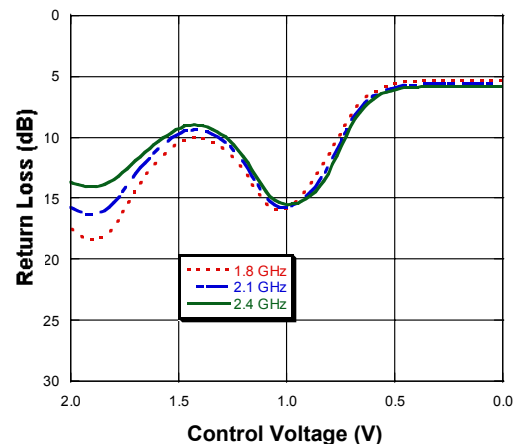

Insertion Loss Delta Normalized to +25°C (-40°C)

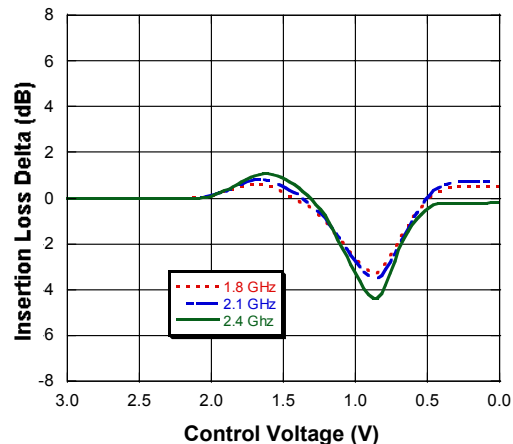

2.25 Volt Voltage Variable Absorptive Attenuator
42 dB, 1.8 - 2.5 GHz

AT-119
V9

Typical Performance Curves

Insertion Loss Delta Normalized to +25°C (+85°C)

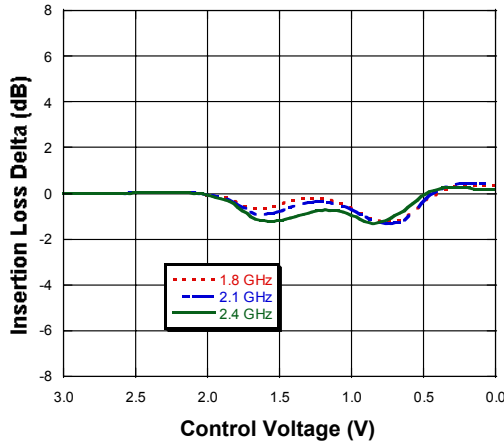

Input IP3 vs. Control Voltage @ +25°C

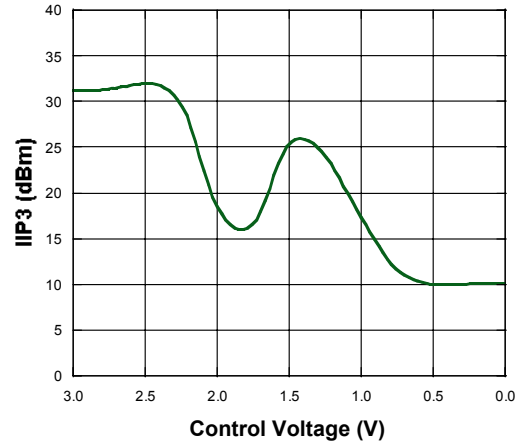

Input Power for 1 dB Change in Attenuation

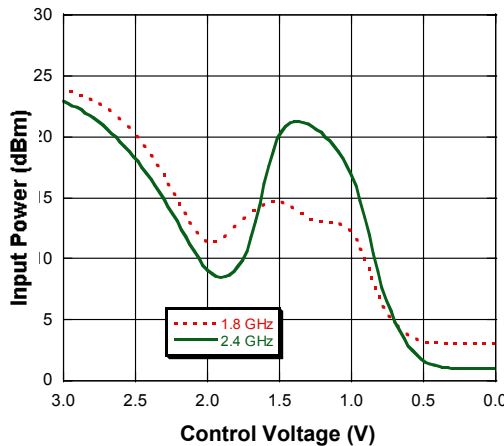

Input IP3 vs. Control Voltage over Temperature

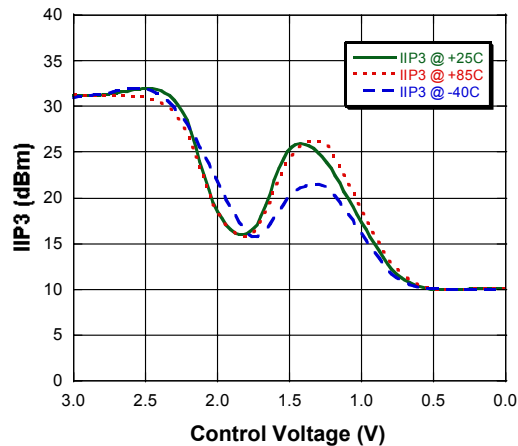

SOT-25

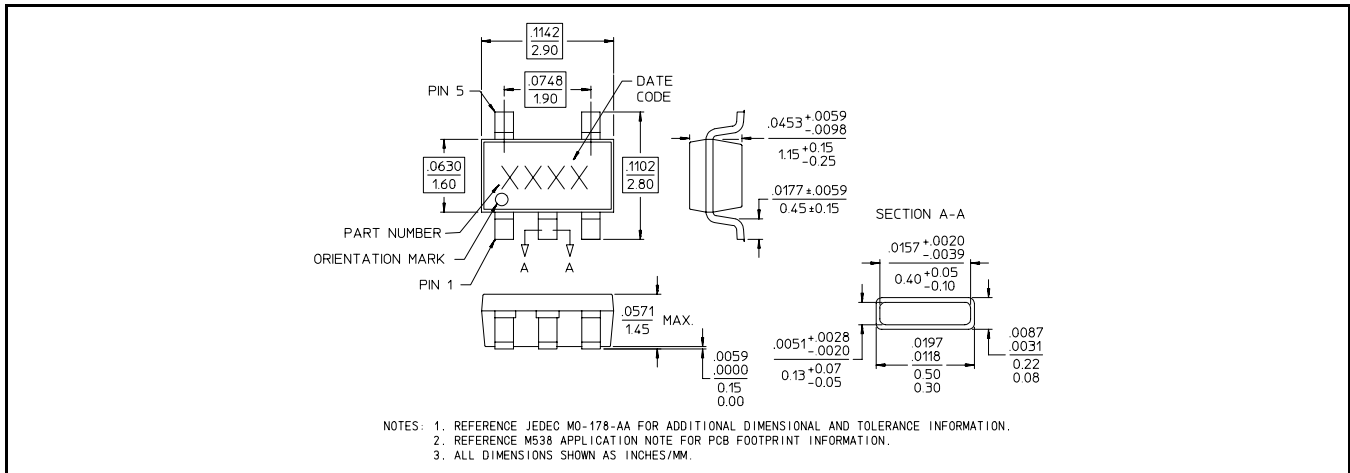

M/A-COM Inc. and its affiliates reserve the right to make changes to the product(s) or information contained herein without notice. M/A-COM makes no warranty, representation or guarantee regarding the suitability of its products for any particular purpose, nor does M/A-COM assume any liability whatsoever arising out of the use or application of any product(s) or information.

- **North America** Tel: 800.366.2266 / Fax: 978.366.2266
- **Europe** Tel: 44.1908.574.200 / Fax: 44.1908.574.300
- **Asia/Pacific** Tel: 81.44.844.8296 / Fax: 81.44.844.8298

Visit www.macom.com for additional data sheets and product information.