

Load Switch with Level-Shift

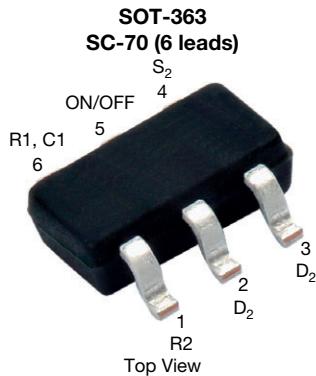

Marking Code: VD

PRODUCT SUMMARY	
V_{DS} (V)	12
$R_{DS(on)}$ (Ω) at $V_{IN} = 4.5$ V	0.200
$R_{DS(on)}$ (Ω) at $V_{IN} = 2.5$ V	0.300
$R_{DS(on)}$ (Ω) at $V_{IN} = 1.8$ V	0.508
I_D (A)	± 1.1
Configuration	Level-shift

APPLICATION CIRCUITS

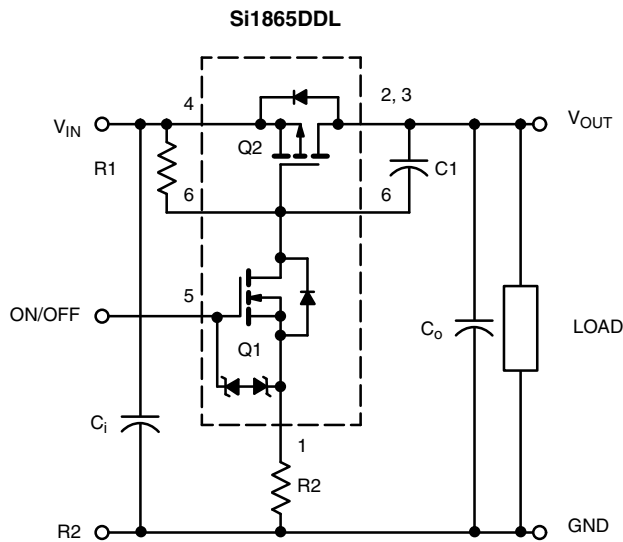

COMPONENTS		
R1	Pull-up resistor	Typical 10 k Ω to 1 M Ω ^a
R2	Optional slew-rate control	Typical 0 to 100 k Ω ^a
C1	Optional slew-rate control	Typical 1000 pF

Note

- a. Minimum R1 value should be at least 10 x R2 to ensure Q1 turn-on

FEATURES

- Low $R_{DS(on)}$ TrenchFET[®]
- 1.8 V to 12 V input
- 1.5 V to 8 V logic level control
- Low profile, small footprint SC-70-6 package
- 2000 V ESD protection on input switch, $V_{ON/OFF}$
- Adjustable slew-rate
- Material categorization: for definitions of compliance please see www.vishay.com/doc?99912



RoHS
COMPLIANT
HALOGEN
FREE

APPLICATIONS

- Load switch with level-shift
- Slew-rate control
- Portable / consumer devices

DESCRIPTION

The Si1865DDL includes a p- and n-channel MOSFET in a single SC-70-6 package. The low on-resistance p-channel TrenchFET is tailored for use as a load switch. The n-channel, with an external resistor, can be used as a level-shift to drive the p-channel load-switch. The n-channel MOSFET has internal ESD protection and can be driven by logic signals as low as 1.5 V. The Si1865DDL operates on supply lines from 1.8 V to 12 V, and can drive loads up to 1.1 A.

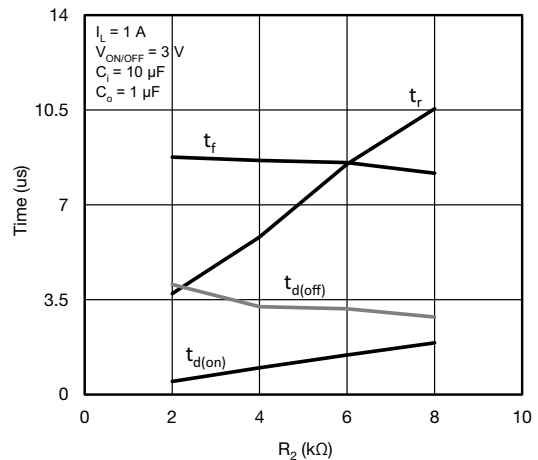

Switching Variation R2 at $V_{IN} = 2.5$ V, $R1 = 20$ k Ω

The Si1865DDL is ideally suited for high-side load switching in portable applications. The integrated n-channel level-shift device saves space by reducing external components. The slew rate is set externally so that rise-times can be tailored to different load types.

FUNCTIONAL BLOCK DIAGRAM

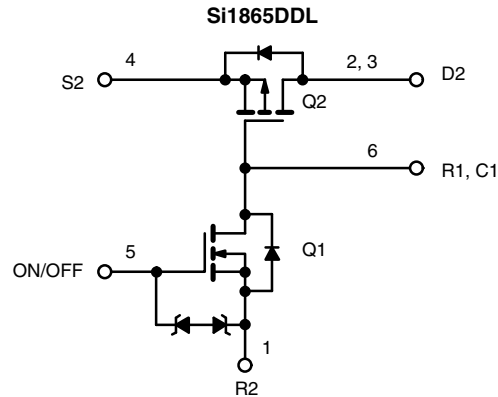

ORDERING INFORMATION	
Package	SC-70
Lead (Pb)-free and halogen-free	Si1865DDL-T1-GE3

ABSOLUTE MAXIMUM RATINGS (T _A = 25 °C, unless otherwise noted)			
PARAMETER	SYMBOL	LIMIT	UNIT
Input voltage	V _{IN} (V _{DS2})	12	V
On/off voltage	V _{ON/OFF}	8	
Load current	Continuous ^{a, b}	± 1.1	A
	Pulsed ^{b, c}	± 5	
Continuous intrinsic diode conduction ^a	I _S	-0.3	
Maximum power dissipation ^a	P _D	0.357	W
Operating junction and storage temperature range	T _J , T _{stg}	-55 to 150	°C
ESD rating, MIL-STD-883D human body model (100 pF, 1500 Ω)	ESD	2	kV

THERMAL RESISTANCE RATINGS				
PARAMETER	SYMBOL	TYPICAL	MAXIMUM	UNIT
Maximum junction-to-ambient (continuous current) ^a	R _{thJA}	290	350	°C/W
Maximum junction-to-foot (Q2)	R _{thJF}	250	300	

SPECIFICATIONS (T _J = 25 °C, unless otherwise noted)						
PARAMETER	SYMBOL	TEST CONDITIONS	MIN.	TYP.	MAX.	UNIT
Off Characteristics						
Reverse leakage current	I _{FL}	V _{IN} = 12 V, V _{ON/OFF} = 0 V	-	-	1	μA
Diode forward voltage	V _{SD}	I _S = -0.8 A	-	-0.84	-1.2	V
On Characteristics						
Input voltage range	V _{IN}		1.8	-	12	V
On-resistance (p-channel)	R _{DS(on)}	V _{ON/OFF} = 1.5 V, V _{IN} = 4.5 V, I _D = 1.1 A	-	0.165	0.200	Ω
		V _{ON/OFF} = 1.5 V, V _{IN} = 2.5 V, I _D = 0.9 A	-	0.250	0.300	
		V _{ON/OFF} = 1.5 V, V _{IN} = 1.8 V, I _D = 0.2 A	-	0.376	0.508	
On-state (p-channel) drain-current	I _{D(on)}	V _{IN-OUT} ≤ 0.2 V, V _{IN} = 5 V, V _{ON/OFF} = 1.5 V	1	-	-	A
		V _{IN-OUT} ≤ 0.3 V, V _{IN} = 3 V, V _{ON/OFF} = 1.5 V	1	-	-	

Notes

- Surface mounted on FR4 board
- V_{IN} = 12 V, V_{ON/OFF} = 8 V, T_A = 25 °C
- Pulse test: pulse width ≤ 300 μs, duty cycle ≤ 2 %

Stresses beyond those listed under "Absolute Maximum Ratings" may cause permanent damage to the device. These are stress ratings only, and functional operation of the device at these or any other conditions beyond those indicated in the operational sections of the specifications is not implied. Exposure to absolute maximum rating conditions for extended periods may affect device reliability.



TYPICAL CHARACTERISTICS (25 °C, unless otherwise noted)

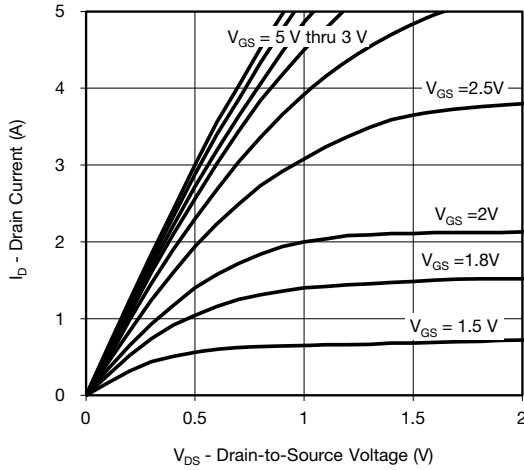

Output Characteristics

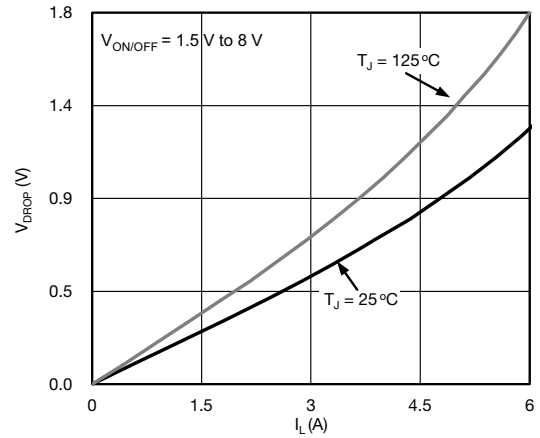

V_{DROD} vs. I_L at $V_{IN} = 4.5 V$

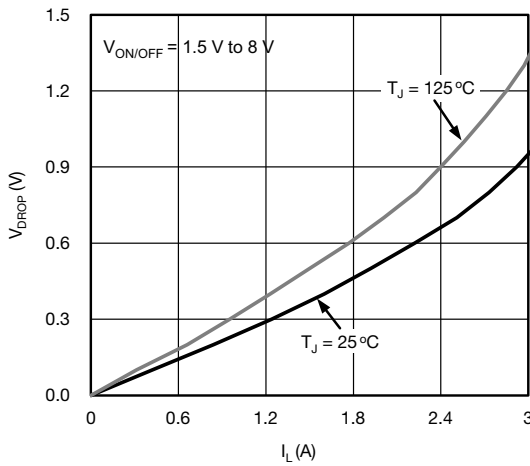

V_{DROD} vs. I_L at $V_{IN} = 2.5 V$

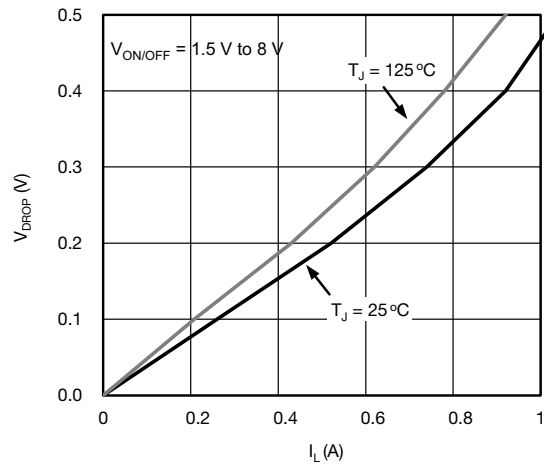

V_{DROD} vs. I_L at $V_{IN} = 1.8 V$

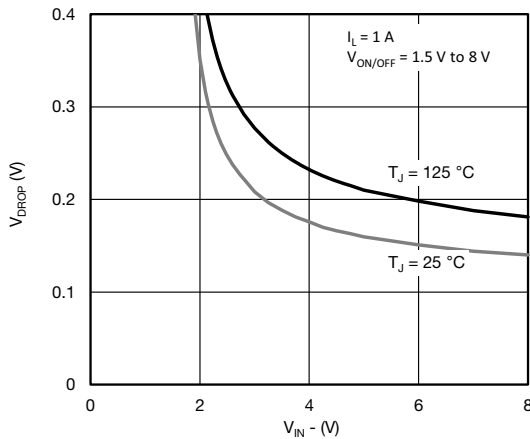

V_{DROD} vs. V_{IN} at $I_L = 1 A$

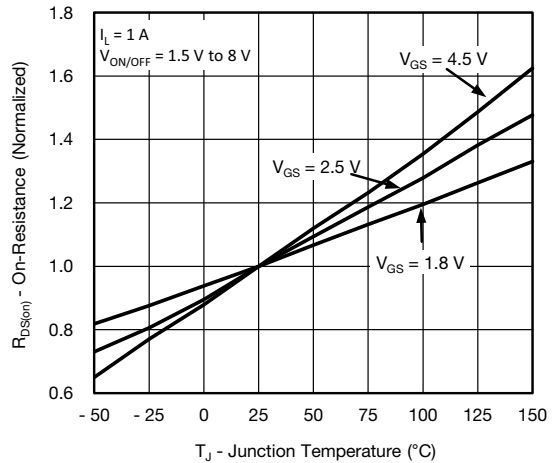

Normalized On-Resistance vs. Junction Temperature



TYPICAL CHARACTERISTICS (25 °C, unless otherwise noted)

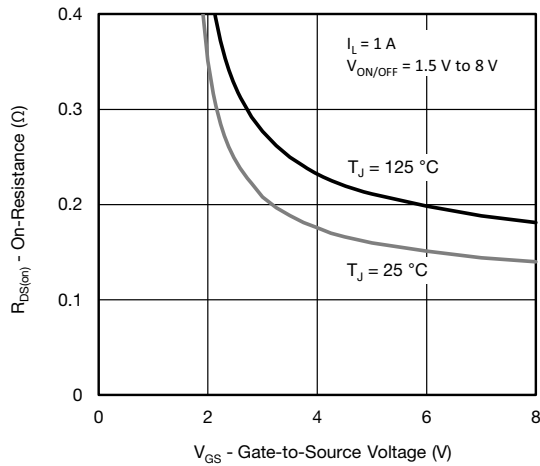

On-Resistance vs. Input Voltage

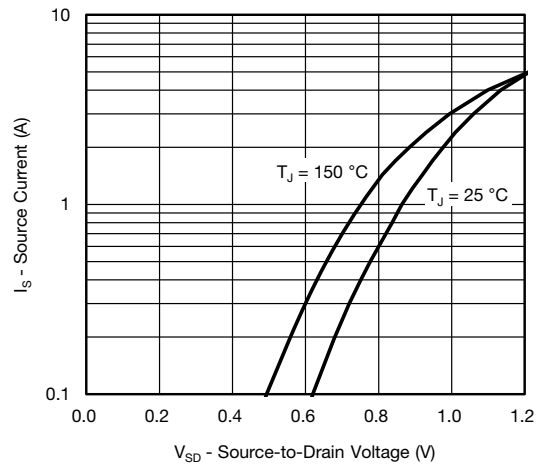

Source-Drain Diode Forward Voltage

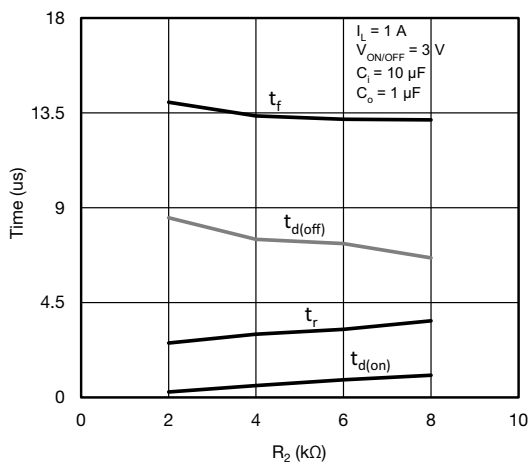

Switching Variation R2 at V_{IN} = 4.5 V, R1 = 20 kΩ

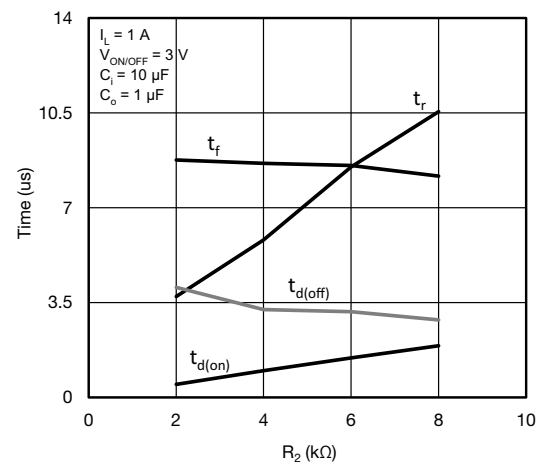

Switching Variation R2 at V_{IN} = 2.5 V, R1 = 20 kΩ

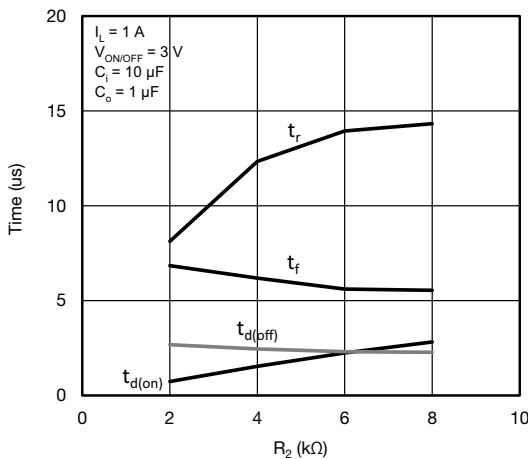

Switching Variation R2 at V_{IN} = 1.8 V, R1 = 20 kΩ

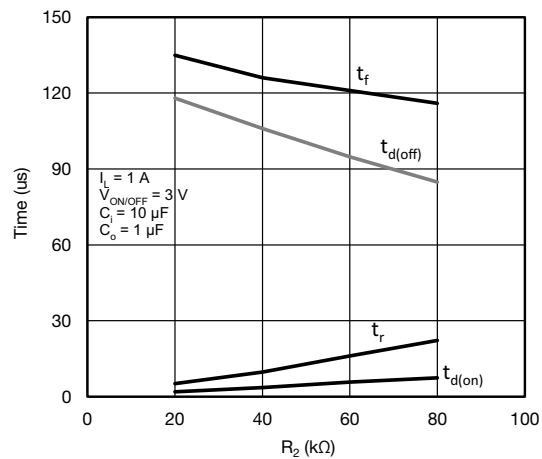

Switching Variation R2 at V_{IN} = 4.5 V, R1 = 300 kΩ

TYPICAL CHARACTERISTICS (25 °C, unless otherwise noted)

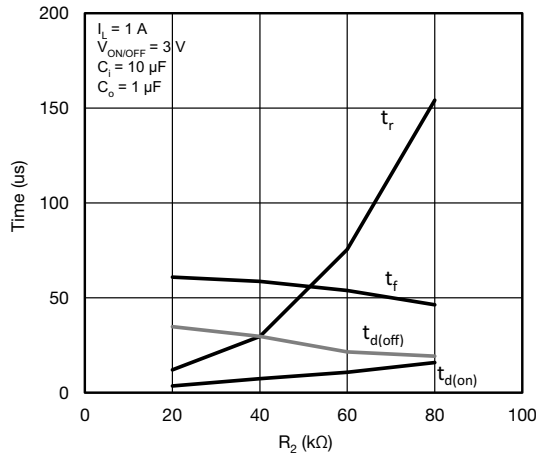

Switching Variation R2 at $V_{IN} = 2.5 \text{ V}$, $R_1 = 300 \text{ k}\Omega$

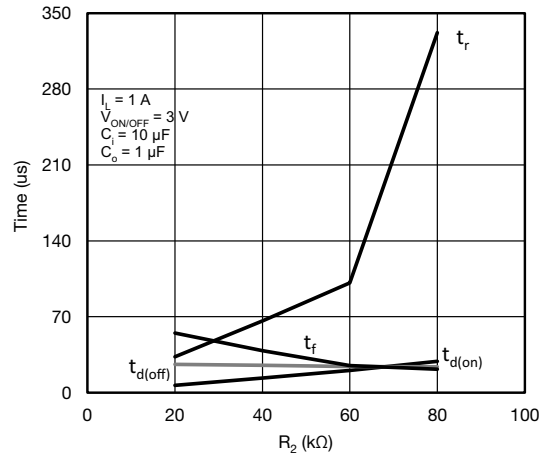

Switching Variation R2 at $V_{IN} = 1.8 \text{ V}$, $R_1 = 300 \text{ k}\Omega$

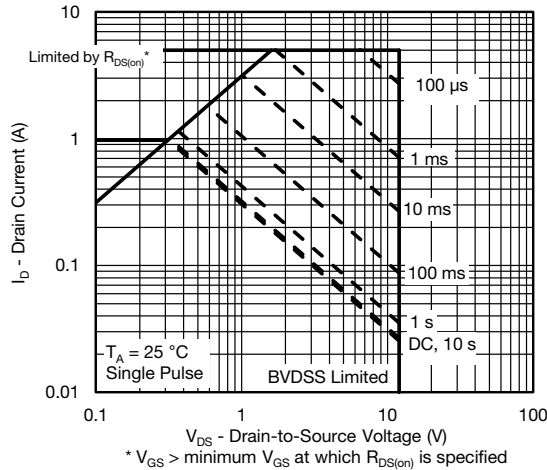

Safe Operating Area, Junction-to-Foot

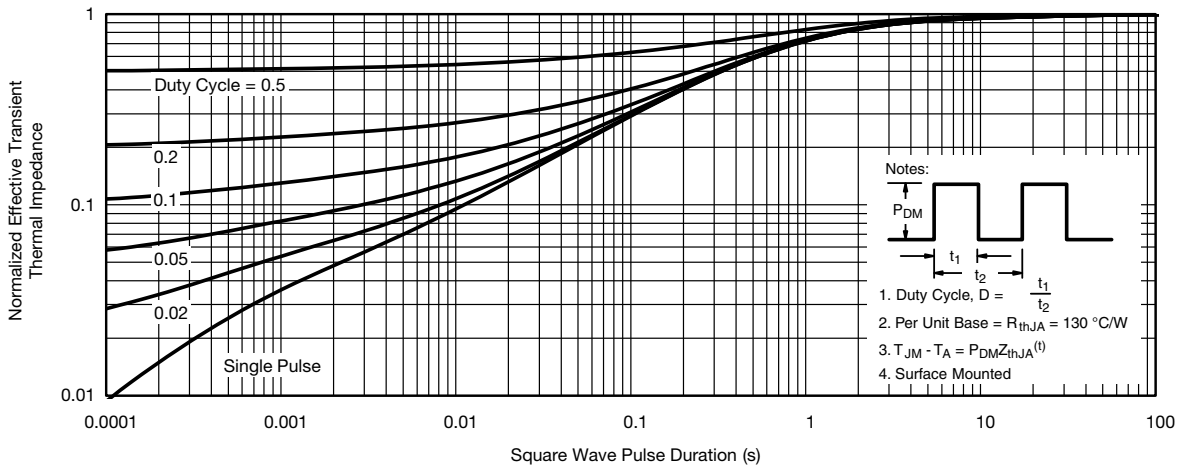

Normalized Thermal Transient Impedance, Junction-to-Ambient

Vishay Siliconix maintains worldwide manufacturing capability. Products may be manufactured at one of several qualified locations. Reliability data for Silicon Technology and Package Reliability represent a composite of all qualified locations. For related documents such as package/tape drawings, part marking, and reliability data, see www.vishay.com/ppg?62888.



SC-70: 6-LEADS

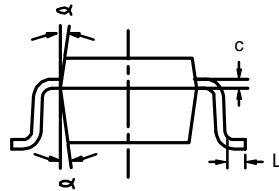
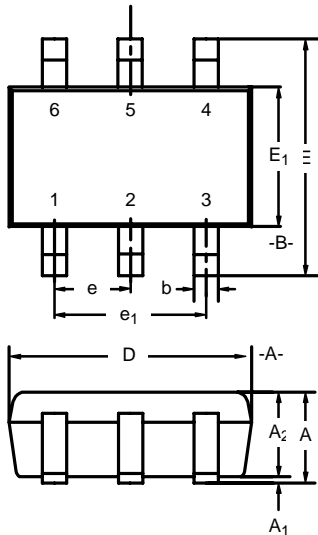

Dim	MILLIMETERS			INCHES		
	Min	Nom	Max	Min	Nom	Max
A	0.90	-	1.10	0.035	-	0.043
A ₁	-	-	0.10	-	-	0.004
A ₂	0.80	-	1.00	0.031	-	0.039
b	0.15	-	0.30	0.006	-	0.012
c	0.10	-	0.25	0.004	-	0.010
D	1.80	2.00	2.20	0.071	0.079	0.087
E	1.80	2.10	2.40	0.071	0.083	0.094
E ₁	1.15	1.25	1.35	0.045	0.049	0.053
e	0.65BSC			0.026BSC		
e ₁	1.20	1.30	1.40	0.047	0.051	0.055
L	0.10	0.20	0.30	0.004	0.008	0.012
α	7°Nom			7°Nom		

ECN: S-03946—Rev. B, 09-Jul-01
DWG: 5550

RECOMMENDED MINIMUM PADS FOR SC-70: 6-Lead

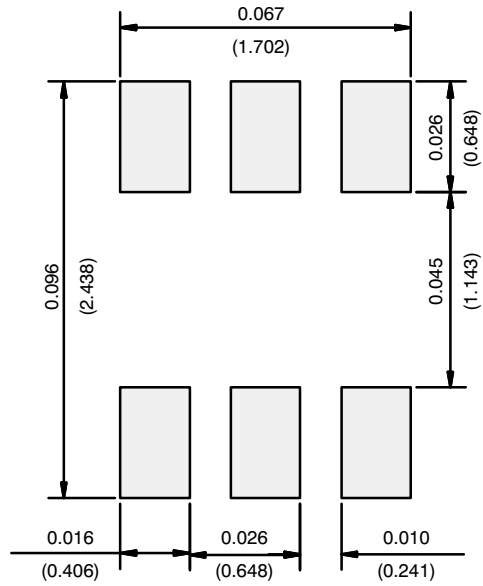

Recommended Minimum Pads
Dimensions in Inches/(mm)

[Return to Index](#)



Disclaimer

ALL PRODUCT, PRODUCT SPECIFICATIONS AND DATA ARE SUBJECT TO CHANGE WITHOUT NOTICE TO IMPROVE RELIABILITY, FUNCTION OR DESIGN OR OTHERWISE.

Vishay Intertechnology, Inc., its affiliates, agents, and employees, and all persons acting on its or their behalf (collectively, "Vishay"), disclaim any and all liability for any errors, inaccuracies or incompleteness contained in any datasheet or in any other disclosure relating to any product.

Vishay makes no warranty, representation or guarantee regarding the suitability of the products for any particular purpose or the continuing production of any product. To the maximum extent permitted by applicable law, Vishay disclaims (i) any and all liability arising out of the application or use of any product, (ii) any and all liability, including without limitation special, consequential or incidental damages, and (iii) any and all implied warranties, including warranties of fitness for particular purpose, non-infringement and merchantability.

Statements regarding the suitability of products for certain types of applications are based on Vishay's knowledge of typical requirements that are often placed on Vishay products in generic applications. Such statements are not binding statements about the suitability of products for a particular application. It is the customer's responsibility to validate that a particular product with the properties described in the product specification is suitable for use in a particular application. Parameters provided in datasheets and / or specifications may vary in different applications and performance may vary over time. All operating parameters, including typical parameters, must be validated for each customer application by the customer's technical experts. Product specifications do not expand or otherwise modify Vishay's terms and conditions of purchase, including but not limited to the warranty expressed therein.

Hyperlinks included in this datasheet may direct users to third-party websites. These links are provided as a convenience and for informational purposes only. Inclusion of these hyperlinks does not constitute an endorsement or an approval by Vishay of any of the products, services or opinions of the corporation, organization or individual associated with the third-party website. Vishay disclaims any and all liability and bears no responsibility for the accuracy, legality or content of the third-party website or for that of subsequent links.

Except as expressly indicated in writing, Vishay products are not designed for use in medical, life-saving, or life-sustaining applications or for any other application in which the failure of the Vishay product could result in personal injury or death. Customers using or selling Vishay products not expressly indicated for use in such applications do so at their own risk. Please contact authorized Vishay personnel to obtain written terms and conditions regarding products designed for such applications.

No license, express or implied, by estoppel or otherwise, to any intellectual property rights is granted by this document or by any conduct of Vishay. Product names and markings noted herein may be trademarks of their respective owners.