

PLEASE CHECK WWW.MOLEX.COM FOR LATEST PART INFORMATION

Part Number: [0876972001](#)
Status: **Active**
Overview: [extreme powerplus_ssi](#)
Description: 6.35mm (.250") Pitch, Power, 2.54mm (.100") Pitch, Signal, EXTreme PowerPlus™ Pa-S Receptacle, Press-fit, Vertical, 0.76µm (30µ") Gold (Au) Plating, 32 Circuits, Leadfree

Documents:

[3D Model](#) [Product Specification PS-87633-006 \(PDF\)](#)
[Drawing \(PDF\)](#) [RoHS Certificate of Compliance \(PDF\)](#)

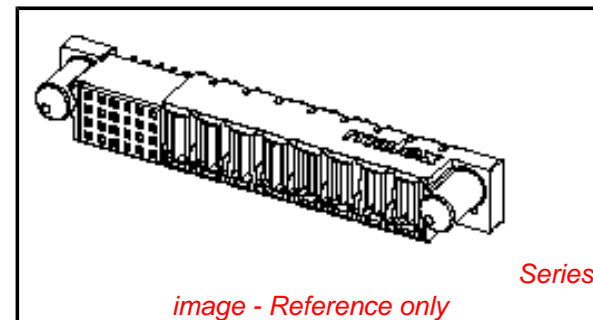

General

Product Family	PCB Receptacles
Series	87697
Application	Board-to-Board
Comments	Recessed Power Circuit Position: A5, A6, A7, A8
Overview	extreme powerplus_ssi
Product Literature Order No	987650-3002
Product Name	EXTreme PowerPlus™

Physical

Circuits (Loaded)	32
Circuits Detail	Power Alpha 8, Signal 24
Color - Resin	Black
Durability (mating cycles max)	100
Glow-Wire Compliant	No
Guide to Mating Part	Yes
Keying to Mating Part	Yes
Material - Metal	Copper Alloy
Material - Plating Mating	Gold
Material - Plating Termination	Tin
Material - Resin	High Temperature Thermoplastic
Number of Rows	4
Orientation	Vertical
PC Tail Length (in)	0.135 In
PC Tail Length (mm)	3.43 mm
PCB Locator	No
PCB Retention	Yes
PCB Thickness Recommended (in)	0.093 In
PCB Thickness Recommended (mm)	2.40 mm
Packaging Type	Tray
Pitch - Mating Interface (in)	0.100 In, 0.250 In
Pitch - Mating Interface (mm)	2.54 mm, 6.35 mm
Plating min: Mating (µin)	30
Plating min: Mating (µm)	0.76
Plating min: Termination (µin)	100
Plating min: Termination (µm)	2.54
Polarized to Mating Part	Yes
Polarized to PCB	Yes
Temperature Range - Operating	-20°C to +105°C
Termination Interface: Style	Through Hole - Compliant Pin

Electrical

Current - Maximum per Contact	2.5A, 30A
Voltage - Maximum	50V DC

Material Info

EU RoHS

ELV and RoHS Compliant
REACH SVHC Contains SVHC: No
Halogen-Free Status
Not Reviewed

China RoHS



Need more information on product environmental compliance?

Email productcompliance@molex.com
 For a multiple part number RoHS Certificate of Compliance, [click here](#)

Please visit the [Contact Us](#) section for any non-product compliance questions.

Search Parts in this Series

[87697Series](#)

Mates With

[87696](#) EXTreme PowerPlus™ Pa-S Header

Reference - Drawing Numbers

Application Specification

Product Specification

Sales Drawing

AS-87631-018, AS-87633-007

PS-87633-006

SD-87697-011

This document was generated on 05/22/2010

PLEASE CHECK WWW.MOLEX.COM FOR LATEST PART INFORMATION

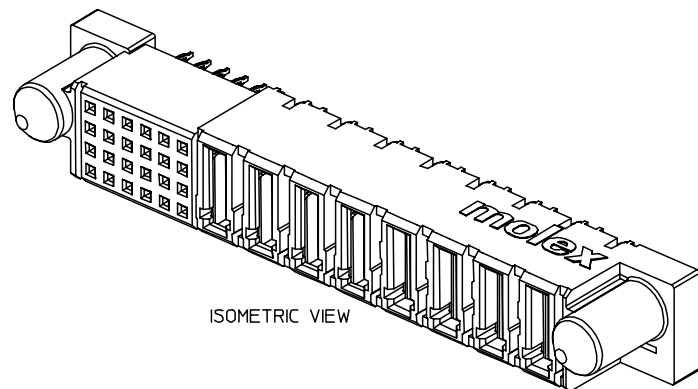
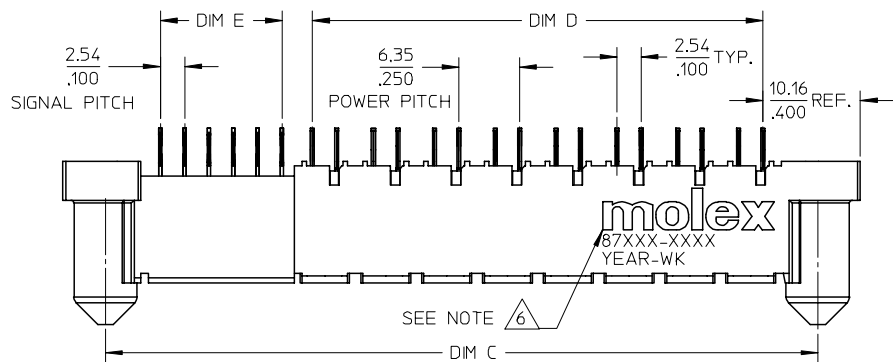

ISOMETRIC VIEW

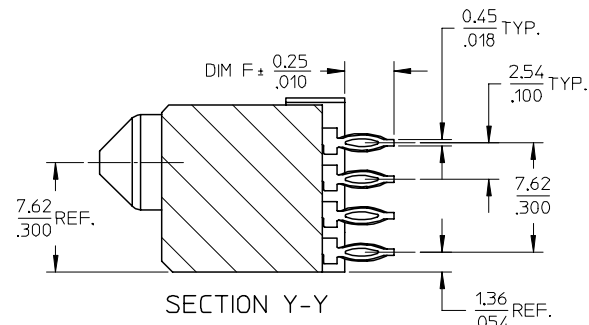
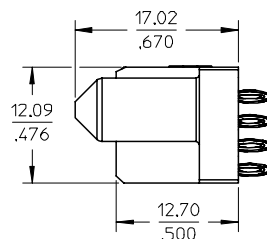
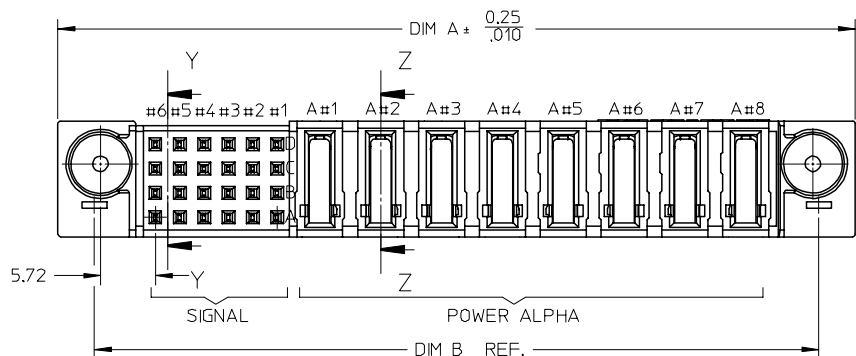

SECTION Y-Y

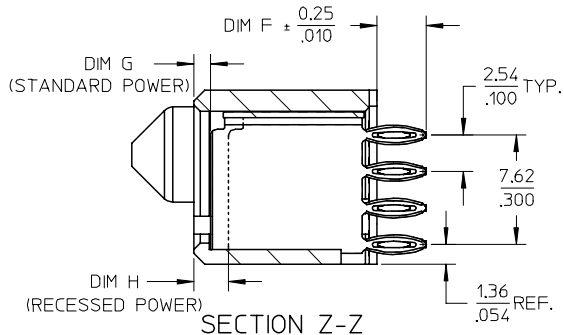

SECTION Z-Z

ADD ASSY P/N FOR L/F EC NO: S2005-0102 DRWN:NRVITAP 2004/08/11 CHKD:PTLIM 2004/08/11 APPR:SCLOW 2004/08/11	QUALITY SYMBOLS ▽ = 0 ▽ = 0	GENERAL TOLERANCES (UNLESS SPECIFIED)		SCALE NTS	DESIGN UNITS METRIC	THIRD ANGLE PROJECTION	REVISE ON CAD ONLY
		4 PLACES ± --- ± ---	3 PLACES ± --- ± ---	DIMENSION STYLE MM/IN		TITLE POWER CONN. RECEPTACLE P(A)-S CONFIGURATION VERTICAL PRESS-FIT	
REV	DESCRIPTION	2 PLACES ± 0.13 ± ---	1 PLACE ± 0.25 ± ---	DRAWN BY KMG0H	DATE 2002/11/18	MATERIAL NO. SEE TABLE	
		ANGULAR ± 3 °		CHECKED BY PTLIM	DATE 2002/11/21	DOCUMENT NO. SD-87697-011	
DRAFT WHERE APPLICABLE		MUST REMAIN WITHIN DIMENSIONS		APPROVED BY SKTOH	DATE 2002/11/21	SHEET NO. 1 OF 2	
THIS DRAWING CONTAINS INFORMATION THAT IS PROPRIETARY TO MOLEX INCORPORATED AND SHOULD NOT BE USED WITHOUT WRITTEN PERMISSION							

PART NUMBER	P-S CONFIGURATION		RECESS POWER CIRCUIT #	DIM A	DIM B	DIM C	DIM D	DIM E	DIM F ±0.25	DIM G	DIM H	PACKAGING	PLATING OPTION
	POWER ALPHA	SIGNAL											
87697-8001	8	24	A#5,A#6,A#7,A#8	83.18 3.275	75.57 2.975	74.29 2.925	46.99 1.850	12.70 .500	3.43 .135	1.07 .042	2.34 .092	TRAY	TIN/LEAD
87697-8002	4	24	NIL	57.78 2.275	50.17 1.975	48.89 1.925	21.59 .850	12.70 .500	3.43 .135	1.07 .042	2.34 .092	TRAY	TIN
87697-2001	8	24	A#5,A#6,A#7,A#8	83.18 3.275	75.57 2.975	74.29 2.925	46.99 1.850	12.70 .500	3.43 .135	1.07 .042	2.34 .092	TRAY	TIN
87697-2002	4	24	NIL	57.78 2.275	50.17 1.975	48.89 1.925	21.59 .850	12.70 .500	3.43 .135	1.07 .042	2.34 .092	TRAY	TIN

CONNECTOR - NOTES

1. MATERIALS :

HOUSING - HIGH TEMPERATURE THERMO-PLASTIC,
GLASS FILLED, UL94-0,COLOR:BLACK.

SIGNAL PIN - COPPER ALLOY

POWER PIN - COPPER ALLOY

2. FINISH :

SIGNAL & POWER CONTACTS

0.76 MICROMETER MINIMUM GOLD (Au) AT CONTACT AREA AND
2.54 MICROMETER MINIMUM TIN/LEAD OR TIN AT SOLDER TAIL AREA
OVER 1.27um MIN. NICKEL (Ni) UNDERPLATE.

3. PRODUCT SPECIFICATION: PS-87633-006.

4. COMPONENT STAY AWAY ZONE FROM CONNECTOR.

5. PCB NOTE FOR DIAMETER 1.02/.040 PLATED HOLE.

- DRILLED HOLE SIZE IS 1.151/.0453

- PLATE WITH 0.007/.0003 MINIMUM TIN/LEAD OR TIN OVER 0.03/.001
TO 0.08/.003 COPPER PLATING TO ACHIEVE 1.02±0.08/.040±.003 HOLE.
SEE SHEET 2 FOR RECOMMENDED PCB LAYOUT.

6. MANUFACTURER LOGO,PART NUMBER AND YEAR-WEEK CODE.

7. 8 POWER ALPHA-24 SIGNAL CONFIGURATION IS SHOWN FOR ILLUSTRATION.

8. IMAGINARY LINE & DIMENSION TO POSITION AND PROVIDE CONNECTOR
ORIENTATION WITH RESPECT TO PCB LAYOUT.

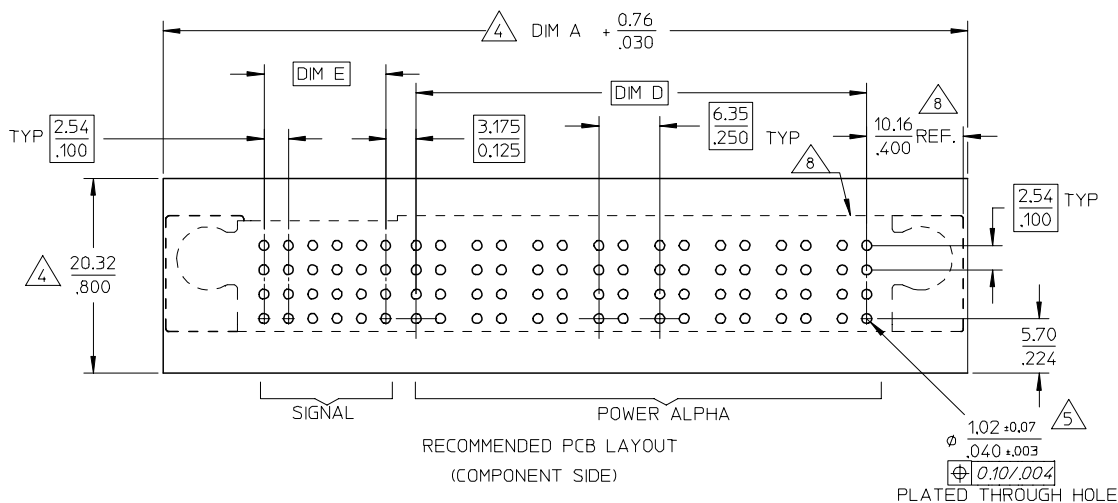

RECOMMENDED PCB LAYOUT
(COMPONENT SIDE)

ADD ASSY P/N FOR L/F EC NO: S2005-0102 DRWN:NRVITAP 2004/08/11 CHKD:PTLIM 2004/08/11 APPR:SCLOW 2004/08/11	QUALITY SYMBOLS ▽ = 0 ▽ = 0	GENERAL TOLERANCES (UNLESS SPECIFIED)		SCALE NTS	DESIGN UNITS METRIC	THIRD ANGLE PROJECTION	REVISE ON CAD ONLY		
			mm	INCH	DIMENSION STYLE MM/IN		TITLE POWER CONN. RECEPTACLE P(A)-S CONFIGURATION VERTICAL PRESS-FIT		
		4 PLACES	± ---	± ---	DRAWN BY KMG0H	DATE 2002/11/18	MATERIAL NO. SEE TABLE		
		3 PLACES	± ---	± ---	CHECKED BY PTLIM	DATE 2002/11/21	DOCUMENT NO. SD-87697-011		
2 PLACES	± 0.13	± ---	DRAFT WHERE APPLICABLE		SHEET NO. 2 OF 2				
1 PLACE	± 0.25	± ---	MUST REMAIN WITHIN DIMENSIONS		THIS DRAWING CONTAINS INFORMATION THAT IS PROPRIETARY TO MOLEX INCORPORATED AND SHOULD NOT BE USED WITHOUT WRITTEN PERMISSION				
		ANGULAR ± 3 °							