

Data sheet | Item number: 787-885

Redundancy Module; 2 x 24 VDC input voltage; 2 x 20 A input current; 24 VDC output voltage; 40 A output current; communication capability; 10,00 mm²

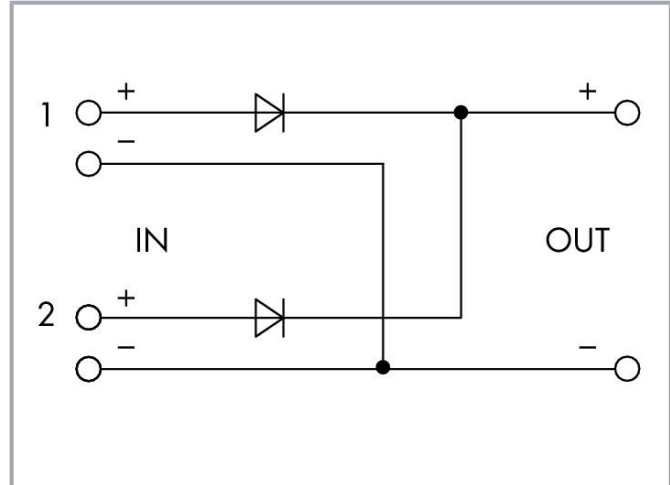

www.wago.com/787-885



Subject to changes. Please also observe the further product documentation!

WAGO Kontakttechnik GmbH & Co. KG
Hansastr. 27
32423 Minden
Phone: +49571 887-0 | Fax: +49571 887-169
Email: info.de@wago.com | Web: www.wago.com

Do you have any questions about our products?
We are always happy to take your call at +49 (571) 887-44222.



Item description

Features:

- Redundancy module with two inputs for decoupling two power supplies
- For redundant and fail-safe power supply
- With LED and potential-free contact for input voltage monitoring on site and remotely

Data

Technical data

Nominal input voltage $U_{i\text{nom}}$	2 x DC 24 V
Input voltage range	2 x DC 18 ... 30 V

Subject to changes. Please also observe the further product documentation!

WAGO Kontakttechnik GmbH & Co. KG
Hansastr. 27
32423 Minden
Phone: +49571 887-0 | Fax: +49571 887-169
Email: info.de@wago.com | Web: www.wago.com

Do you have any questions about our products?
We are always happy to take your call at +49 (571) 887-44222.



Nominal mains frequency range	0 Hz
Input current I_i	≤ 20 A (per path)
Power loss P_i	≤ 1.5 W (No load); ≤ 14 W (24 VDC; 20 A); ≤ 26 W (48 VDC; 40 A)
Efficiency (typ.)	97 %
Nominal output voltage $U_{o\ nom}$	DC 24 V
Output voltage range	DC 18 ... 30 V (U_e – voltage drop)
Voltage drop	≤ 0.6 V (Input/output)
Nominal output current $I_{o\ nom}$	40 A
Nominal output power	960 W
Output power (max.)	≤ 1200 W
Isolation voltage (connectors – housing)	DC 0.5 kV
Protection class	III
Protection type	IP20 (per EN 60529)
Reverse voltage protection	yes
Resistance to reverse feed	\leq DC 33 V
Pollution degree	2
Parallel operation	Yes
Series operation	No
MTBF	> 500,000 h (per IEC 61709)
Internal fuse	No
Signaling	1 x OUT LED (green) 1 x IN1 LED (yellow) 1 x IN2 LED (yellow) 1 x Isolated relay contact (max. 30 VDC; 1 A)
Operation status indicator	Green LED (U_o) 2 x Yellow LED (U_i)

Connection data

Connection type (1)	Input/Output
Connection technology	Push-in CAGE CLAMP®
WAGO Connector	WAGO 831 Series
Solid conductor	0.5 ... 10 mm ² / 20 ... 8 AWG
Fine-stranded conductor	0.5 ... 10 mm ² / 20 ... 8 AWG
Strip length	13 ... 15 mm / 0.51 ... 0.59 inch
Connection type 2	Relay
Connection technology 2	

Subject to changes. Please also observe the further product documentation!



CAGE CLAMP®	
WAGO Connector 2	<i>picoMAX</i> ® 5.0, WAGO 2092 Series
Solid conductor 2	0.08 ... 2.5 mm ² / 28 ... 12 AWG
Fine-stranded conductor 2	0.08 ... 2.5 mm ² / 28 ... 12 AWG
Strip length 2	8 ... 9 mm / 0.31 ... 0.35 inch

Physical data

Width	40 mm / 1.575 inch
Height	181 mm / 7.126 inch
Depth from upper edge of DIN-rail	163 mm / 6.417 inch
Note (dimensions)	Height with connector

Mechanical data

Mounting type	DIN-35 rail
---------------	-------------

Material data

Weight	972 g
--------	-------

Environmental requirements

Surrounding air temperature (operation)	-10 ... 60 °C
Surrounding air temperature (storage)	-25 ... 85 °C
Relative humidity	5 ... 96 % (no condensation permissible)

Standards and specifications

Conformity marking	CE
Standards/Specifications	EN 60950 UL 60950 UL 508 EN 61000-6-2 EN 61000-6-3

Commercial data

Product Group	6 (Interface Electronics)
PU (SPU)	1 Stück
Packaging type	box
Country of origin	DE

Subject to changes. Please also observe the further product documentation!



WAGO Kontakttechnik GmbH & Co. KG
Hansastr. 27
32423 Minden
Phone: +49571 887-0 | Fax: +49571 887-169
Email: info.de@wago.com | Web: www.wago.com

Do you have any questions about our products?
We are always happy to take your call at +49 (571) 887-44222.

GTIN	4045454909802
Customs tariff number	85044090900

Approvals / Certificates



UL-Approvals

Logo	Approval	Additional Approval Text	Certificate name
	UL Underwriters Laboratories Inc.	UL 508	E255817
	UL Underwriters Laboratories Inc.	UL 60950-1	E255815





Optional accessories

Marking accessories

Marking strip

	Item no.: 2009-110 Marking strips; for Smart Printer; on reel; not stretchable; plain; snap-on type; white	www.wago.com/2009-110
	Item no.: 210-831 Marking strips; on reel; 2.3 mm wide; plain; Self-adhesive; white	www.wago.com/210-831
	Item no.: 210-832 Marking strips; on reel; 3 mm wide; plain; Self-adhesive; white	www.wago.com/210-832

Marker

	Item no.: 2009-145 Mini-WSB Inline; for Smart Printer; 1700 pieces on roll; stretchable 5 - 5.2 mm; plain; snap-on type; white	www.wago.com/2009-145
	Item no.: 2009-115 WMB-Inline; for Smart Printer; 1500 pieces on roll; stretchable 5 - 5.2 mm; plain; snap-on type; white	www.wago.com/2009-115
	Item no.: 248-501 Mini-WSB marking card; as card; not stretchable; plain; snap-on type; white	www.wago.com/248-501
	Item no.: 793-501 WMB marking card; as card; not stretchable; plain; snap-on type; white	www.wago.com/793-501

Subject to changes. Please also observe the further product documentation!

**Item no.: 793-5501**

WMB marking card; as card; for terminal block width 5 - 17.5 mm; stretchable 5 - 5.2 mm; plain; snap-on type; white

www.wago.com/793-5501

Ferrule		
Ferrule		
	Item no.: 216-203 Ferrule; Sleeve for 1 mm ² / AWG 18; insulated; electro-tin plated; red	www.wago.com/216-203
	Item no.: 216-206 Ferrule; Sleeve for 2.5 mm ² / AWG 14; insulated; electro-tin plated; blue	www.wago.com/216-206
	Item no.: 216-207 Ferrule; Sleeve for 4 mm ² / AWG 12; insulated; electro-tin plated; gray	www.wago.com/216-207
	Item no.: 216-202 Ferrule; Sleeve for 0.75 mm ² / 18 AWG; insulated; electro-tin plated; gray	www.wago.com/216-202
	Item no.: 216-204 Ferrule; Sleeve for 1.5 mm ² / AWG 16; insulated; electro-tin plated; black	www.wago.com/216-204
	Item no.: 216-205 Ferrule; Sleeve for 2.08 mm ² / AWG 14; insulated; electro-tin plated; yellow	www.wago.com/216-205
	Item no.: 216-208 Ferrule; Sleeve for 6 mm ² / AWG 10; insulated; electro-tin plated; electrolytic copper; gastight crimped; acc. to DIN 46228, Part 4/09.90; yellow	www.wago.com/216-208
	Item no.: 216-201 Ferrule; Sleeve for 0.5 mm ² / 20 AWG; insulated; electro-tin plated; white	www.wago.com/216-201
	Item no.: 216-223 Ferrule; Sleeve for 1 mm ² / AWG 18; insulated; electro-tin plated; red	www.wago.com/216-223
	Item no.: 216-241 Ferrule; Sleeve for 0.5 mm ² / 20 AWG; insulated; electro-tin plated; electrolytic copper; gastight crimped; acc. to DIN 46228, Part 4/09.90; white	www.wago.com/216-241
	Item no.: 216-242 Ferrule; Sleeve for 0.75 mm ² / 18 AWG; insulated; electro-tin plated; electrolytic copper; gastight crimped; acc. to DIN 46228, Part 4/09.90; gray	www.wago.com/216-242
	Item no.: 216-222 Ferrule; Sleeve for 0.75 mm ² / 18 AWG; insulated; electro-tin plated; gray	www.wago.com/216-222
	Item no.: 216-221 Ferrule; Sleeve for 0.5 mm ² / 20 AWG; insulated; electro-tin plated; white	www.wago.com/216-221
	Item no.: 216-224 Ferrule; Sleeve for 1.5 mm ² / AWG 16; insulated; electro-tin plated; black	www.wago.com/216-224
	Item no.: 216-243 Ferrule; Sleeve for 1 mm ² / AWG 18; insulated; electro-tin plated; electrolytic copper; gastight crimped; acc. to DIN 46228, Part 4/09.90; red	www.wago.com/216-243
	Item no.: 216-244 Ferrule; Sleeve for 1.5 mm ² / AWG 16; insulated; electro-tin plated; electrolytic copper; gastight	www.wago.com/216-244



Subject to changes. Please also observe the further product documentation!

crimped; acc. to DIN 46228, Part 4/09.90; black

	Item no.: 216-263 Ferrule; Sleeve for 1 mm ² / AWG 18; insulated; electro-tin plated; electrolytic copper; gastight crimped; acc. to DIN 46228, Part 4/09.90; red	www.wago.com/216-263
	Item no.: 216-246 Ferrule; Sleeve for 2.5 mm ² / AWG 14; insulated; electro-tin plated; electrolytic copper; gastight crimped; acc. to DIN 46228, Part 4/09.90; blue	www.wago.com/216-246
	Item no.: 216-266 Ferrule; Sleeve for 2.5 mm ² / AWG 14; insulated; electro-tin plated; electrolytic copper; gastight crimped; acc. to DIN 46228, Part 4/09.90; blue	www.wago.com/216-266
	Item no.: 216-264 Ferrule; Sleeve for 1.5 mm ² / AWG 16; insulated; electro-tin plated; electrolytic copper; gastight crimped; acc. to DIN 46228, Part 4/09.90; black	www.wago.com/216-264
	Item no.: 216-284 Ferrule; Sleeve for 1.5 mm ² / AWG 16; insulated; electro-tin plated; electrolytic copper; gastight crimped; acc. to DIN 46228, Part 4/09.90; black	www.wago.com/216-284
	Item no.: 216-286 Ferrule; Sleeve for 2.5 mm ² / AWG 14; insulated; electro-tin plated; electrolytic copper; gastight crimped; acc. to DIN 46228, Part 4/09.90; blue	www.wago.com/216-286
	Item no.: 216-287 Ferrule; Sleeve for 4 mm ² / AWG 12; insulated; electro-tin plated; electrolytic copper; gastight crimped; acc. to DIN 46228, Part 4/09.90; gray	www.wago.com/216-287
	Item no.: 216-262 Ferrule; Sleeve for 0.75 mm ² / 18 AWG; insulated; electro-tin plated; electrolytic copper; gastight crimped; acc. to DIN 46228, Part 4/09.90; gray	www.wago.com/216-262
	Item no.: 216-288 Ferrule; Sleeve for 6 mm ² / AWG 10; insulated; electro-tin plated; electrolytic copper; gastight crimped; acc. to DIN 46228, Part 4/09.90; yellow	www.wago.com/216-288
	Item no.: 216-301 Ferrule; Sleeve for 0.25 mm ² / AWG 24; insulated; electro-tin plated; yellow	www.wago.com/216-301
	Item no.: 216-321 Ferrule; Sleeve for 0.25 mm ² / AWG 24; insulated; electro-tin plated; yellow	www.wago.com/216-321
	Item no.: 216-322 Ferrule; Sleeve for 0.34 mm ² / 22 AWG; insulated; electro-tin plated; green	www.wago.com/216-322
	Item no.: 216-267 Ferrule; Sleeve for 4 mm ² / AWG 12; insulated; electro-tin plated; electrolytic copper; gastight crimped; acc. to DIN 46228, Part 4/09.90; gray	www.wago.com/216-267
	Item no.: 216-302 Ferrule; Sleeve for 0.34 mm ² / 22 AWG; insulated; electro-tin plated; green	www.wago.com/216-302

Tool

Operating tool

	Item no.: 210-721 Operating tool; Blade: 5.5 x 0.8 mm; with a partially insulated shaft; multicoloured	www.wago.com/210-721
	Item no.: 210-720	

Subject to changes. Please also observe the further product documentation!

Operating tool; Blade: 3.5 x 0.5 mm; with a partially insulated shaft; multicoloured

www.wago.com/210-720

Mounting adapter

Wall-mount adapter

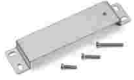

Item no.: 787-895

Mounting carrier; for screw fixing of 787-8xx devices on mounting plate or wall without DIN 35 rail

www.wago.com/787-895

DIN-rail adapter



Item no.: 787-897

Carrier rail adapter made of zinc die-cast; for mounting 787-8xx devices to a DIN 35 rail

www.wago.com/787-897



Item no.: 787-896

Carrier rail adapter; for mounting 787-8xx devices to a DIN 35 rail

www.wago.com/787-896

Downloads

Documentation

Bid Text

787-885 X81 - Datei	2019. 7. 15.	xml 6.1 kB	Download
787-885 docx - Datei	2019. 7. 15.	docx 22.5 kB	Download

Instruction Leaflet

Redundanzmodul DC 24 V, 20 A		pdf 278.8 kB	Download
---------------------------------	--	-----------------	----------

Additional Information

Disposal; Electrical and electronic equipment, Packaging	V 1.0.0	pdf 265.8 kB	Download
----------------------------------------------------------	---------	-----------------	----------

CAD/CAE-Data

CAD data

2D/3D Models 787-885		URL	Download
----------------------	--	-----	----------

CAE data

WSCAD Universe 787-885		URL	Download
------------------------	--	-----	----------

Subject to changes. Please also observe the further product documentation!



ZUKEN Portal 787-885

[URL](#)

[Download](#)

EPLAN Data Portal 787-885

[URL](#)

[Download](#)

Environmental Product Compliance

Compliance Search

Environmental Product Compliance 787-885

[URL](#)

[Download](#)

Redundancy Module; 2 x 24 VDC input voltage; 2 x 20 A input current; 24 VDC output voltage; 40 A output current; communication capability; 10,00 mm²

Installation Notes

Subject to changes. Please also observe the further product documentation!

WAGO Kontakttechnik GmbH & Co. KG

Hansastr. 27

32423 Minden

Phone: +49571 887-0 | Fax: +49571 887-169

Email: info.de@wago.com | Web: www.wago.com

Do you have any questions about our products?

We are always happy to take your call at +49 (571) 887-44222.